

Index

Introduction	… P. 3
Common Guidelines	… P. 7
Academic Services	… P. 17
Academic Records	… P. 51
Faculty of Science and Technology Curriculum	… P. 61
Sophia Program for Sustainable Futures (SPSF) Curriculum	… P. 103
General Information	… P. 191

Introduction

The Educational Ideals of Sophia University

… P. 4

INTRODUCTION

The Educational Ideals of Sophia University

Based on Christian principles of education, Sophia University attests to the Jesuit Order's four-hundred-year-old interest in Japan. The aim of Sophia University is to prepare individuals coming from different countries to recognize the fundamental unity of the human race in the different cultural traditions of the world and to work for the concrete achievement of that unity. The roots of the university go back to 1549, when St. Francis Xavier, a Jesuit, landed in Kagoshima with the hope of starting a Catholic university which would introduce Western culture to Japan. In 1908, nearly 360 years later, three members of the Society of Jesus—the German Father Joseph Dahlmann, the French Father Henri Boucher, and the English Father James Rockliff came to Japan with the mission of fulfilling St. Francis Xavier's aspiration. As a result of their efforts, Sophia University was established in 1913, when the Japanese Ministry of Education gave the Jesuits permission to found a new educational institution under the Japanese name of Jōchi Gakuin. Sixteen students enrolled in the first class. Sophia University has grown from these modest beginnings to become one of Japan's foremost private universities with a student body of over 12,000 undergraduate and graduate students and a teaching staff of more than one thousand. In the tradition of the international character of Sophia University's founders, the faculty members represent approximately twenty different nationalities; they are committed to conveying both humankind's cultural and intellectual heritage and a concern for the problems facing the world today to the next generation through their scholarship and teaching.

Loyola Web Service

The Loyola Web Service is the Official academic web portal of Sophia University. The Loyola Web Service (Loyola) brings together on one website important information and services related to academic matters.

Using the Loyola Web Service students will be able to:

- Search course schedule and classrooms
- Register and withdraw from courses
- Check their registration status and grades
- Check information concerning cancelled classes, make-up classes, or notices on the Loyola web bulletin board through PCs and mobile phones
- Update the registered data if there are any changes in the student's or guarantor's address
- Check and submit report assignments

Please refer to the "Loyola Handbook" (available online via Loyola) for detailed explanations on how to use Loyola.

Common Guidelines



2022 Calendar For the Academic Year	… P. 8
Frequently Asked Questions	… P. 12
Offices to Visit for Inquiries / Office hours	… P. 14
Announcements and Notices on Loyola	… P. 15
Guidance Programs	… P. 15
How to Contact Your Teachers	… P. 16
Change of Address	… P. 16
When Public Transport Service is Shut Down	… P. 16
Protection of Personal Information	… P. 16

Academic Year 2022 Spring/1Q/2Q Calendar

2022 **3** March

Mon	Tue	Wed	Thu	Fri	Sat	Sun
28	29	30	31			

Key

-  Make-up classes
-  Classes Held on Holidays
-  No class days

Sat	Sun	No
	Holiday	Class



2022 **4** April

Mon	Tue	Wed	Thu	Fri	Sat	Sun
				1	2	3
4	5	6	7	8	9	10
11	12	13	14	15	16	17
18	19	20	21	22	23	24
25	26	27	28	 29	30	



2022 **5** May

Mon	Tue	Wed	Thu	Fri	Sat	Sun
						1
2	3	4	5	6	7	8
9	10	11	12	13	 14	15
16	17	18	19	20	21	22
23	24	25	26	27	28	29
30	31					

2022 **6** June

Mon	Tue	Wed	Thu	Fri	Sat	Sun
		1	^{1Q←} 2	3 →2Q	4	5
6	7	8	9	10	11	12
13	14	15	16	17	 18	19
20	21	22	23	24	 25	26
27	28	29	30			

2022 **7** July

Mon	Tue	Wed	Thu	Fri	Sat	Sun
				 1	2	3
4	5	6	7	8	 9	10
11	12	13	14	15	16	17
 18	19	20	21	22	23	24
25	26	27	28	29	30	31

2022 **8** August

Mon	Tue	Wed	Thu	Fri	Sat	Sun
1	2	3	4	5	6	7
8	9	10	11	12	13	14
15	16	17	18	19	20	21
22	23	24	25	26	27	28
29	30	31				

2022 **9** September

Mon	Tue	Wed	Thu	Fri	Sat	Sun
			1	2	3	4
5	6	7	8	9	10	11
12	13	14	15	16	17	18
19	20					



Year/ Month	Date	Day	Academic Calendar
March	22	Tue	Deadline for Submission of 2021 Autumn semester / 3Q / 4Q Request for Grade Review
	30	Wed	Guidance for Transfer, Re-admission, Second Degree Admission students.
	30-31	Wed-Thu	Guidance by the Department for the current students
April	1	Fri	Spring semester / 1Q begins
	1	Fri	Entrance Ceremony for new degree students
	4 - 10	Mon - Sun	Medical Checkup
	4 - 7	Mon - Thu	Sophia Orientation Day
	12	Tue	Spring semester and 1Q classes begin
	12	Tue	Certificate of Prospective Graduation (Japanese/English) will be available
			[Course registration / withdrawal period for Spring semester/1Q/2Q courses] For details, please refer to p.26
	1 - 11	Fri - Mon	Course registration period
	1 - 8	Fri - Fri	Lottery entry
	9	Sat	Results of Lottery entry available on Loyola
	9 - 11	Sat - Mon	Lottery course registration (first-come-first-served-basis)
	11	Mon	Results of course registration available on Loyola
	12 - 18	Tue - Mon	Course adjustment period
	20	Wed	Final confirmation of course registration available on Loyola
	29	Fri	Classes held on national holiday
	30	Sat	Leave of absence application deadline for Spring semester and 1Q
May	2 - 6	Mon - Fri	Withdrawal period for 1Q courses
	14	Sat	Make-up classes
	14	Sat	1Q Final examination schedule available on Loyola
	28, Jun. 4	Sat	1Q Final examinations
June	2	Thu	1Q classes end
	3	Fri	2Q classes begin
	3 - 9	Fri - Thu	2Q extra course registration
	13 - 17	Mon - Fri	Withdrawal period for Spring semester and 2Q courses
	18, 25	Sat	Make-up classes
	30	Thu	Leave of absence application deadline for 2Q
July	1	Fri	No class day
	9	Sat	Spring semester / 2Q Final examination schedule available on Loyola
	9	Sat	Make-up classes
	18	Mon	Classes held on national holiday
	22	Fri	Spring semester and 2Q classes end
	23 - 30	Sat - Sat	Spring semester / 2Q Final examinations period (Jul. 30: spare day)
	31	Sun	Summer vacation (until Sep. 26)
	31	Sun	Intensive courses held (until Sep. 20)
August	25	Thu	[Seniors and Graduating students] Grades / Self-Evaluation available (until Sep. 20) Spring semester / 1Q / 2Q Request for Grade Review (Aug. 25 and 26)
			*Make-up exams scheduled at the end of the month
September	10	Sat	Announcement of graduating students on Loyola
	10	Sat	[Freshmen, Sophomores, Juniors, Exchange, Non-degree] Grades / Self-Evaluation available Spring Semester / 1Q / 2Q Request for Grade Review (Sep. 10 - 14)
	12	Mon	Latest Official Transcripts available Certificate of Graduation for graduating students available (until Sep. 20)
	12	Mon	Notice sent to guarantors of students who will continue on after their 8th semester
	20	Tue	Graduation Ceremony
	20	Tue	Spring semester / 2Q ends

Academic Year 2022 Autumn/3Q/4Q Calendar

2022 **9** September

Mon	Tue	Wed	Thu	Fri	Sat	Sun
		21	22	23	24	25
26	27	28	29	30		

Key





-  Make-up classes
-  Classes Held on Holidays
-  No class days

Sat	Sun Holiday	No Class
-----	----------------	-------------

2022 **10** October

Mon	Tue	Wed	Thu	Fri	Sat	Sun
					1	2
3	4	5	6	7	8	9
 10	11	12	13	14	15	16
17	18	19	20	21	 22	23
24	25	26	27	28	29	30
31						





2022 **11** November

Mon	Tue	Wed	Thu	Fri	Sat	Sun
	 1	 2	3	 4	5	6
7	8	9	10	11	12	13
14	15	16	17	18 ^{3Q<}	19 ^{-4Q}	20
21	22	 23	24	25	26	27
28	29	30				

2022 **12** December

Mon	Tue	Wed	Thu	Fri	Sat	Sun
			1	2	 3	4
5	6	7	8	9	 10	11
12	13	14	15	16	17	18
19	20	21	22	23	24	25
26	27	28	29	30	31	

2023 **1** January

Mon	Tue	Wed	Thu	Fri	Sat	Sun
						1
2	3	4	5	6	 7	8
9	10	11	12	 13	 14	15
16	17	18	19	20	 21	22
23	24	25	26	27	28	29
30	31					

2023 **2** February

Mon	Tue	Wed	Thu	Fri	Sat	Sun
		1	2	3	4	5
6	7	8	9	10	11	12
13	14	15	16	17	18	19
20	21	22	23	24	25	26
27	28					

2023 **3** March

Mon	Tue	Wed	Thu	Fri	Sat	Sun
		1	2	3	4	5
6	7	8	9	10	11	12
13	14	15	16	17	18	19
20	21	22	23	24	25	26
27	28	29	30	31		

Year/ Month	Date	Day	Academic Calendar
September	21	Wed	Autumn semester / 3Q begins Entrance Ceremony
	23 - 24	Fri - Sat	Orientation Camp
	27	Tue	Autumn semester / 3Q classes begin
	27	Tue	Certificate of Prospective Graduation (Japanese/English) will be available
			[Course registration / withdrawal period for Autumn semester/3Q/4Q courses] For details, please refer to p.26
	21 - 28	Wed - Wed	Course registration period
	21 - 25	Wed - Sun	Lottery entry
	26	Mon	Results of Lottery entry available on Loyola
	26 - 28	Mon - Wed	Lottery course registration (first-come-first-served-basis)
	29	Thu	Results of course registration available on Loyola
	30 - 3	Fri - Mon	Course adjustment period
October	5	Wed	Final confirmation of course registration available on Loyola
	3	Mon	Early graduation application (for March graduation)
	18 - 19	Tue - Wed	Withdrawal period for 3Q courses
	22	Sat	Make-up classes
	29	Sat	3Q Final examination schedule available on Loyola
	31	Mon	Leave of absence application deadline for Autumn semester and 3Q
November	1	Tue	No class day (Foundation Day)
	2	Wed	No class day
	4	Fri	No class day
	12, 19	Sat	3Q Final examinations
	18	Fri	3Q classes end
	19	Sat	4Q classes begin
	18 - 24	Fri - Thu	4Q extra course registration
	23	Wed	Classes held on national holiday
	28 - Dec. 1	Mon - Thu	Withdrawal period for Autumn semester and 4Q courses
December	3	Sat	No class day (St. Xavier's Day)
	10	Sat	Make-up classes
	20	Tue	Leave of absence application deadline for 4Q
	24	Sat	Classes end for the year
	25	Sun	Winter vacation (- Jan. 5)
January, 2023	6	Fri	Autumn semester and 4Q classes resume
	10	Tue	Autumn semester and 4Q Final examination schedule available on Loyola
	13, 14	Fri, Sat	No class days
	7, 21	Sat	Make-up classes
	23	Mon	Autumn semester / 4Q classes end
	24 - 31	Tue - Tue	Autumn semester / 4Q Final examinations period (Jan. 31: spare day)
February	1	Wed	Spring vacation begins (- Mar. 31)
	22	Wed	[Seniors and Graduating students] Grades / Self-Evaluation available (- Mar. 31) Autumn Semester / 3Q / 4Q Request for Grade Review (Feb. 22 - 26) *Make-up exams scheduled around the latter half of the month
March	15	Wed	Announcement of graduating students on Loyola Latest Official Transcripts available Certificate of Graduation for graduating students available (until Mar. 31)
	15	Wed	Notice sent to guarantors of students who will continue on after their 8th semester
	15	Wed	[Freshmen, Sophomores, Juniors, Exchange, Non-degree] Grades / Self-Evaluation / Latest Official Transcripts available Autumn Semester / 3Q / 4Q Request for Grade Review (Mar. 15 - 22)
	28	Tue	Graduation Ceremony
	31	Fri	Autumn Semester / 4Q ends

Frequently Asked Questions

Q Which offices should I go to with my questions?

A The following list shows offices and their services. For the locations of offices, see p.14

	Office	Tel	Bldg	Floor
Course Registration / Class Information / Transfer Credits / Examination / Grades	Center for Academic Affairs	03-3238-3515	No. 2	1F
Tuition and Fees	Center for Academic Affairs	03-3238-3195	No. 2	1F
Request for Leave of Absence Request for Withdrawal from the University Student ID Card Re-issuance Change of Address / Guarantor Re-admission / Transfer of Faculty / Department College Student Status (VISA)	Center for Academic Affairs (Academic Records Section)	03-3238-3519	No. 2	1F
Student advice service, Extracurricular, Volunteer Activities Assistance for Students with Special Needs Accident Insurance, Part-time jobs Applications for Nursery & Prayer Room, etc.	Center for Student Affairs	03-3238-3525	No. 2	1F
Sophia Dormitory		03-3238-4621		
Financial Support (Scholarship)		03-3238-3523		
Lost & Found	Office of Property	03-3238-3112	No. 2	1F
Exchange Program (Inbound / Outbound) Short-term Language Programs Short-term Study Abroad Programs Social Engagement Programs Study Abroad Insurance Monbukagakusho (MEXT) Scholarship	Center for Global Education and Discovery	03-3238-3521	No. 2	1F
Internship Courses, Summer Session, Global Competency Program				
Job search activities / Internship / Seminars	Career Center	03-3238-3581	No. 2	1F
Campus Ministry / Jesuit Education	Catholic Jesuit Center	03-3238-4161 03-3238-3408	No.2	1F
Teacher and Curator Certification Programs	Center for Teaching and Curator Credentials	03-3238-3520	No. 2	2F
Consultation / Application for using computer, Moodle, mail, network, Zoom, etc.	ICT Office https://ccweb.cc.sophia.ac.jp/en/ Ict Support e-mail: ict-support@sophia.ac.jp	03-3238-3101	No. 2	3F
Student Travel Fare Discount Certificates Certificates / Official Transcript	Vending Machine		No. 2	4F
Studies in Christian Humanism / Embodied Wisdom / The Art of Thinking and Expression / Data Science / Issues, Perspectives and Positionality	Center for Liberal Education and Learning	03-3238-4600	No. 2	1F
Language Courses / Placement Test / AC-TEAP / Individual Advising for Language Courses / Texts for e-learning	Center for Language Education and Research	03-3238-3699	No. 6	5F
Counseling	Counseling Services	03-3238-3559	No. 10	3F
Admissions	Admissions Office	03-3238-3167	No. 12	1F
Resources	Library	03-3238-3510	Central Library	1F
Health Services	Health and Wellbeing Center Health Services	03-3238-3394	Hoffmann Hall	2F
SPSF General Information	SPSF Office	03-3238-3020	No. 2	2F

Q How should I contact my teachers?

A Check the faculty status of your teacher, full-time or part-time, on the List of Instructors (Academic Handbook 履修要覧 Bulletin of Information). Names marked with an asterisk “*” are part-time lecturers. See p.16 for detail.

Q Where and when can I get information and advice on course enrollment?

A Academic Services of the Center for Academic Affairs provide information and advice on course enrollment (no telephone inquiries about course enrollment, grades, credits etc. are accepted). Please visit the office during the office hours on weekdays. See office hours on Loyola.

Q I went to the classroom listed on the timetable, but a different class was in session.

A The classroom may have been changed. Check the updated classroom information on Loyola, under “Class Bulletin Board” and “Course Schedule”.

Q The class period has started, but the instructor is not in the classroom; what should I do?

A First, check on Loyola for cancelled classes.

If your class is not on the list of cancelled classes and the instructor does not come to class 30 minutes past the scheduled starting time, please notify the Center for Academic Affairs and follow their instructions.

Q I have to be absent from class for family bereavement; is there a notice for authorized absence I should hand in?

A Sophia University does not have a system for authorized absence from class or notices of pre-approved absence.

If you were absent from class for unavoidable reasons, please see your class instructor in person and explain the situation. The Center for Academic Affairs cannot relay your message of absence from class. When you return to the university, contact the teachers of the courses you are taking (if you were absent because of infectious diseases, see p.20). If you were absent during the Final Exams period, you may be allowed to take a make-up exam (p.36~).

Q I want to know the schedule of university holidays and final exams, etc.

A Please refer to the 2022 Calendar for the Academic Year (p.8~)

● Office to Visit for Inquiries

The following list shows the various sections of the Center for Academic Affairs and their services:

Inquiries on:	Section/desk numbers
Teacher's license, curator certification program	Center for Teaching and Curator Credentials desk 2F, Building No.2
Course registration, grades, classes, credits	Center for Academic Affairs (Academic Services) No.⑥ sections for each Department
Certificates, Student ID Card, change of address, leave of absence, study abroad, college student status etc.	Center for Academic Affairs (Academic Records) No.⑤
Tuition and fees	Center for Academic Affairs (Tuition & fees) No.④

(※) In general, students should visit the offices for inquiries; telephone inquiries are not accepted, especially inquiries regarding course enrollment, grades etc.

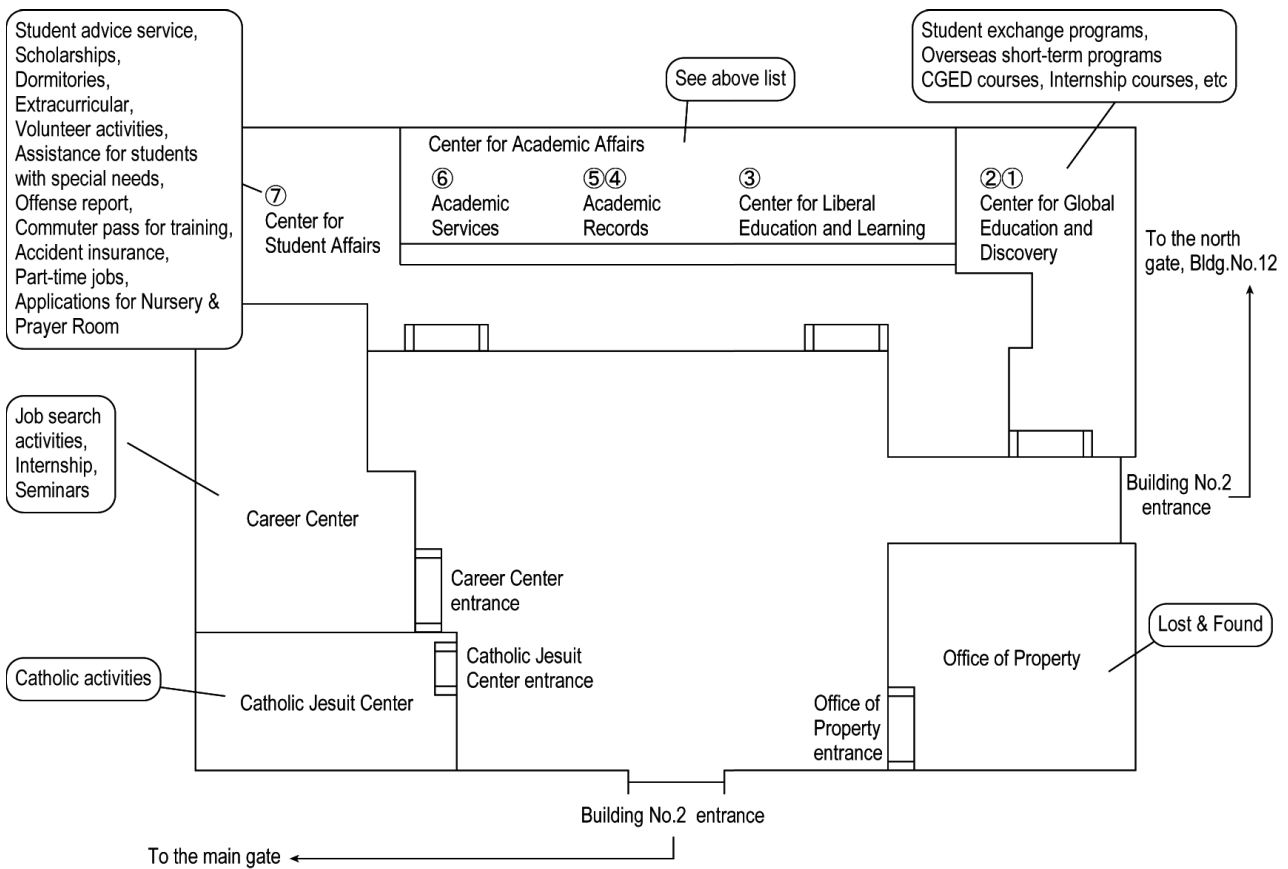

● Office Hours

Period	office hours
April 1 to July 30	10:00 - 11:30 / 12:30 - 15:30
July 31 to September 20	12:30 - 15:30
September 21 to January 31	10:00 - 11:30 / 12:30 - 15:30
February 1 to March 31	12:30 - 15:30

- ※ Services are available only during the above office hours for providing information and accepting applications and required documents.
- ※ Offices are closed on Saturdays, Sundays, national holidays and school holidays.
- ※ Office hours during summer and winter vacations and in special cases are announced on the Loyola Bulletin Board for the Center for Academic Affairs (Academic Services).

● Announcements and Notices on Loyola

All announcements from the university to students will be posted via internet on the Loyola Bulletin Board. Any disadvantages that may arise from failure to check the Loyola Bulletin Board are the responsibility of individual students.

All announcements on class information (cancelled classes, make-up classes, temporary change of classrooms, notices on exams and reports), messages to individual students and important urgent notices are posted on Loyola.

Please check the Loyola Bulletin Board everyday for updated information from the university. The University may also post written announcements at the bulletin boards located on Yotsuya Campus. Please check the campus bulletin board locations on the end sheet.

<Loyola Bulletin Board> Important announcements are posted here; check every day!

Bulletin Boards	Information posted
Class Bulletin Board	Change of classrooms, notices from class teachers ※For cancelled classes, make-up classes, see “Bulletin Board (Cancel & Make up class/ Classroom Changes) →Cancel/ Make-up classes/ Temporary Changes of Classroom Inquiry” Students can only check information on the courses they registered for.
Individual notices	Messages to individual students from various offices; if paged, respond immediately
Bulletin Board for Center for Academic Affairs (Academic Services)	Important announcements on course registration, changes of curriculum etc.
Bulletin Board for Center for Academic Affairs (Academic Records, Tuition)	Announcements regarding academic records, tuition and fees, certificates etc.
University Bulletin Board	Information on events related to Sophia; announcements from the university *Important information like course registration and curriculum changes will be posted under the category, “Academic Services”
Faculty and department office	Announcements from each Department /Program

< Other information available on Loyola >

Information	Menu for inquiries
Check my classroom	Curriculum, Course Registration Info → Course Schedule → Inquiry on Course Schedule (Undergraduate)
Check for cancelled classes, make-up classes, temporary change of classrooms	Bulletin Board (Cancel & Make up class/ Classroom Changes) →Cancel/ Make-up classes/ Temporary Changes of Classroom Inquiry
Check the syllabus	Curriculum, Course Registration Info →Syllabus Inquiry
Register for courses; check the data I entered for course registration	Curriculum, Course Registration Info →Course registration — Course Registration, status of course registration Inquiry
Check my grades	Grades →Grade Inquiry
Use self-evaluation function	Grades →Self Evaluation
Check Final Exam schedule, report assignments	Final Exams →Final Exams Timetable Inquiry (for students)
Learn various functions of Loyola and how to operate them.	HOME →Loyola Handbook (for students)

● Guidance Programs

At university, students are expected to decide on and to plan their own studies. There are various guidance programs held at the beginning of the semester to help them in course selection, registration and to give information on curriculum contents and study activities. Be sure to attend these. The following are the main guidance programs:

Students	Should attend these guidance programs:
First year students	New students guidance
Second year students and above	Current students guidance
Students intending to take teaching license course	Teaching license course orientation (April) Guidance session for new students of teaching license course (September)
Intending to take curator license course	Guidance session for new students of curator license course

Additional guidance programs may be offered as necessary; date and time of each program will be announced on Loyola.

● How to Contact Your Teachers

The class teachers are either full-time faculty of Sophia or part-time lecturers from other universities coming to teach a particular course. The procedures for contacting teacher differ depending on whether they are full-time or part-time:

■ Full-time faculty:

Full time faculty have offices on campus and individual office hours for student appointments. If you need to make an appointment outside of office hours, contact your Department office for instructions.

Also, there are class advisors and academic advisors for each undergraduate class or seminar. The students may seek their advice on studies, course enrollment, career options and any difficulties in student life.

• List of teachers' offices and their office hours	:	Loyola
• Other Department offices	:	Loyola
• List of principal class teachers / academic advisors of Departments	:	Loyola

■ Part-time lecturers

Part-time lecturers do not have offices on campus; contact them before or after classes. Some teachers may release their personal e-mail addresses to students.

Information on whether or not a teacher releases his/her contact information is available at the Center for Academic Affairs (Academic Services). Students should bring their Student ID Cards and inquire in person.

For the protection of personal information, the office does not accept telephone inquiries.

The Center for Academic Affairs does not relay messages from students to their teachers.

■ If you do not know whether the teacher you wish to contact is full-time or part-time teacher:

Please check the list of courses with names of class teachers (Loyola) to see whether the teacher is full-time or part-time.

The teachers with an asterisk "*" in front of their names are part-time lecturers; those without an asterisk are full-time faculty.

● Change of Address

If there are any changes in address of the student or the guarantor, enter data on Loyola from the "Change of address of students" menu.

If there is a change in address of a guarantor residing abroad, please submit the "Change of address" form to the Center for Academic Affairs; you cannot make the change on Loyola.

If there is a change in address of the student, receive a new "enrollment sticker" from the Center and paste it on the back of your Student ID Card.

● When Public Transport Service is Shut Down

When public transport services are shut down due to natural disasters such as typhoons and heavy rainfall or due to accidents or strikes and it is difficult to hold classes or final exams, special measures will be taken to cancel classes or change exam schedules. The special measures will be announced on the official university website, Loyola, the official Facebook or the official Twitter page; the students are responsible for checking the websites for information.

● Protection of Personal Information

For Sophia School Corporation's policy on the protection of personal information, visit the following site:

<https://www.sophia.ac.jp/eng/info/privacypolicy/privacypolicy.html>

Academic Services

(Course Registration/Grades/Classes)

1. Courses ...P. 18

Duration of Course/ Duration of Semester and Quarter/ Class Hours/ "Virtual Days" / Classes on National Holidays/ Classrooms/ Textbooks/ Class Cancellation/Make-up Classes/Absence from Class/ Infectious Diseases/ Absence from Class due to Selection as Lay Judge

2. University-Wide Policies Concerning Education ...P. 22

Three Policies / Curriculum Map / Curriculum Tree

3. Credits and Courses ...P. 23

Credits/Course Composition/ Course Types

4. Numbering ...P. 24

5. Course Registration ...P. 26

Course Registration Schedule/ Course Registration / Limit on Number of Credits per Semester/ Year/ Repetition of Courses/ Lottery Courses/ Points to note on Course Registration

6. Enrollment in Courses Offered by Faculty of Liberal Arts ...P. 31

Application Procedure for Course Enrollment/ Summer Session in Asian Studies

7. Course Withdrawal ...P. 32

Withdrawal from Courses/
Points to note on Course Withdrawal/
Request by "Course Withdrawal Request" Forms

8. Examinations ...P. 34

Types of exam/ Announcement of Schedule of Final Exams (written tests)/Report Exams/ Examination (written tests) Policy/ Cheating on

Final Exams (written tests) is Strictly Prohibited/
If Public Transport Service is Shut Down/
Make-up Exams/ Cheating on Report Exams is Strictly Prohibited/ Stance on Exams, Reports, Papers

9. Evaluation / Grades ...P. 40

Evaluation Criteria/ GPA/ Grades Release Dates/ Request for Grade Review/Guidance for the Students Whose GPA is Less Than 0.5/Students with no Prospects of Academic Progress

10. Graduation Requirements and Self Evaluation ...P. 43

Graduation Requirements/
Check Credits Required for Graduation/
How to Check Credits Required for Graduation

11. Credit Transfer and Approval ...P. 44

Credit Transfer and Approval/
Grades of Courses with Transferred Credits/
Application Period for Credit Transfer and Approval/ Transfer of Pre-matriculation Credits/
Credit Transfer of Transfer Students/
Credit Transfer for Teacher Certification Program/ Graduate School Pre-admission Course Enrollment System/ Credit Transfer by Student Exchange Agreement/ Credit Transfer from Study Abroad

12. Certification Program ...P. 47

13. Overseas Short-term Language Programs/ Short-term Study Abroad Programs/ Social Engagement programs ...P. 48

Credit from Overseas Short-term Language Program/ Credit from Overseas Short-term Study Abroad Program/ Credit Transfer of Social Engagement Programs and Internship courses

1. Courses

● Duration of Course

The duration of a course in one academic year is basically 35 weeks including the final exam period. For the first and last dates of courses and the final exam period, please see the 2022 Calendar for the Academic Year (p.8~).

Semester	Spring			Autumn		
	Class		Recess	Class		Recess
	14 wks				14 wks	
Quarter	1Q	2Q		3Q	4Q	
	Class	Class	Recess	Class	Class	Recess
	7 wks	7 wks		7 wks	7 wks	

● Duration of Semester and Quarter

The duration of semesters is as follows:

Spring Semester: April 1 to September 20

1st Quarter: April 1 to June 2

2nd Quarter: June 3 to September 20

Autumn Semester: September 21 to March 31

3rd Quarter: September 21 to November 18

4th Quarter: November 19 to March 31

● Class Hours

Class period	Hours
1	9 : 00~10 : 40
2	10 : 55~12 : 35
3	13 : 30~15 : 10
4	15 : 25~17 : 05
5	17 : 20~19 : 00
6	19 : 10~20 : 50

※1 Exceptions to the above regular class days and hours are Intensive Courses held on Saturdays, vacations, Sundays or during make-up class periods. The dates, hours and classrooms for these courses are announced on the Loyola Bulletin Board (Academic Services) or “Class Bulletin Board”. (These courses are listed on the Course Schedule as “Intensive Courses”).

● “Virtual Days”

“Virtual Days” are scheduled to make up for classes with an insufficient number of classes due to falling on certain days of the week of national holidays; classes are held on a day of the week different from that of the original schedule.

For the 2022 virtual days, please see the 2022 Calendar for the Academic Year (p.8~).

● Classes on National Holidays

Classes may be held on national holidays to ensure that sufficient numbers of classes are held. For classes of the 2022 Academic Year held on national holidays, please see the 2022 Calendar for the Academic Year (p.8~).

● Classrooms

Classes are generally held in the classrooms shown on Loyola. However, there may be changes in classrooms, temporary and for the whole semester due to the number of attending students or installed equipment. At the beginning of a semester, there may be frequent classroom changes. Please make it a habit of checking the classroom on Loyola before you go to your classes.

- Changes of classrooms for the whole semester
The new classrooms and the dates of changes will be posted on the Loyola Class Bulletin Board. Please also check the changes on Loyola under “Curriculum / Course Registration” → “Course Schedule” or “Bulletin board / Cancel & Make-up Classes” → “Class cancellation & Make-up Class”.
- Temporary changes of classrooms
Please check on Loyola under “Cancel & Make-up class”

● Textbooks

The textbooks necessary for classes and reference books will be listed on Loyola under “Curriculum Course Registration Info→Syllabus Inquiry”. If you are not required to have them prepared before classes start, follow the instructions of the teacher of the first day of class.

The textbooks and reference book order are available through the Kinokuniya website at the start of the semester. For details, please see the Loyola Bulletin Board(University Bulletin Board)

● Class Cancellation

If a class teacher cannot hold classes for reasons such as official duties, official trips, academic meetings, or illness, the classes may be cancelled. Information on class cancellation will be announced on Loyola when the class teacher notifies the office. However, under unavoidable circumstances we may have to announce the cancellation on the day of the class, so please make sure to check Loyola before you go to your classes every day.

If your class is not on the cancelled class list on Loyola but the teacher does not appear in class 30 minutes after the scheduled starting time, please notify the Center for Academic Affairs and follow their instructions.

● Make-up Classes

Make-up classes are normally held on predetermined dates scheduled in the Spring and Autumn Semesters, but they may be held on other days. In both cases, the classroom, date and time of make-up classes will be announced on Loyola. Please check Loyola before you attend the make-up class.

For 2022 Make-up classes, check the 2022 Calendar for the Academic Year (p.8~). Note that the make-up classes are held in the same manner as regular classes as they are intended to make up for classes that were cancelled.

● Absence from Class

Sophia University does not have a system for registering an authorized absence from class or accounting a pre-approved absence. The Center for Academic Affairs cannot relay your message of absence. If you are absent from class due to unavoidable reasons such as bereavement, delay in public transport service, illness, extracurricular activities, or job searching, you need to contact your class teacher and explain the situation. However, if you are absent during the Final Exams period, you may be allowed to take a make-up exam (p.36~).

If you need to be absent for a long period of time due to illness or injury, consult the Department Chairperson or your class advisor on Loyola.

● Infectious Diseases

When students contract an infectious disease as defined by the School Health and Safety Act (influenza, measles, whooping cough, rubella, mumps, chicken pox etc.), the students are not allowed to come to school for a certain period of time to prevent the spread of the disease. Should you contract such a disease, take the following steps:

If students contract a new infectious disease, special measures may be taken; please check announcements on Loyola and the official university website.

1. You must follow your physician's instructions and stay home until there is no risk of infection. Please notify the University Health and Wellbeing Center Health Services of your situation by Loyola, phone, or fax (download the report form from the official university website).
2. Download the "Doctor's permission to return to campus (Toko Kyoka Sho)" (感染症治癒後登校許可証明書) from the official university website and have it filled out by your physician (a form from any medical organization may be used if it states the period the student is not allowed to go to school).
※ If you cannot download the form, ask for the form at the Health and Wellbeing Center Health Services.
3. When you return to school, submit the above original certificate to Health and Wellbeing Center Health Services and photocopies to each of your class teachers.
※ For absence during the final exam period, refer to "Make-up exams" on p.36.

*How to report when infected or in close contact with COVID-19

Students are required to report to the University Health and Wellbeing Center Health Services when infected or in close contact with COVID-19.

-Loyola: Fill in the questionnaire "Report for novel coronavirus infection / close contact"

-Phone: Call the Health and Wellbeing Center Health Services at +(81)3-3238-3394

For more details and latest updates, check the university website:

<https://www.sophia.ac.jp/eng/news/covid19.html>

● Absence from Class due to Selection as Lay Judge

The lay judge system introduced in recent years according to “Act on Criminal Trials Examined under Lay Judge System” allows students to decline to serve as lay judges. However, to respect the intentions of students selected wishing to serve as lay judges, students may serve through the following procedures:

1. Students who may apply:
Full-time undergraduate or graduate degree students of Sophia University and non-matriculated students (excluding auditing students).
 2. Reasons justified for applying
 - 1) Appearing at a courthouse as a lay judge candidate for appointment procedures
 - 2) Attending a trial as a lay judge
 - 3) To attend a court as an alternate lay judge member
 3. Procedures
In general, students must contact the Center for Academic Affairs, receive a copy of the designated Notification of Absence due to Lay Judge Service form, and submit this form, along with a copy of the Notice of Date for Lay Judge Appointment sent in the mail from the court, to the faculty member(s) in charge of the class(es) from which the student is to be absent. The student must also show to the faculty member(s) the post-trial discharge certification documentation issued by the court.
 4. Absence from class
When the student follows the above procedures, the teacher will process the absence as follows so that the student will not be at a disadvantage.
 - 1) Classes: the student will not be considered “absent”; providing any alternative measures will be at the discretion of the teacher.
 - 2) In-class exam: the student will not be considered “absent”; providing any alternative measures will be at the discretion of the teacher.
 - 3) Final exams: the student may take a make-up exam; the student must follow the usual procedures and submit a request for make-up exam by the deadline (p.36~).
- * For reference:
Students are eligible to be selected as lay judge candidates but the law defines that they may decline to serve. The possible options related to court appearance are as follows:
(Options for students)
- a) A student may follow the lay judge selection procedures and participate in court as a lay judge.
 - b) A student may decline to serve because you have the student status.
 - c) A student may decline to serve if summoned during the final exam period or any other specific month or day.
- (Reasons justified for declining to serve)
- You have a reason for declining to serve justified for the whole year--namely your “student” status.
 - You have a specific month in which it is extremely difficult to serve as a lay judge; during final exams.
 - You have an important service in social life that cannot be performed on any other date.

2. University-Wide Policies Concerning Education

【Three Policies】

Sophia University has defined its education and research objectives for each Faculty and Department.

Diploma Policy: a fundamental policy in accordance with the University's educational ideals, clarifying skills, and knowledge that students are expected to have acquired to be awarded a bachelor's degree, and a guide for students when making their academic plans.

Curriculum Policy: a policy to organize the curriculum and define ways of learning in order to meet the Diploma Policy.

Admissions Policy: a guideline for admitting students based on our educational ideals and the two policies mentioned above.

Education and Research Objectives, Human Resource Development Objectives, and Diploma and Curriculum Policies are found in the Bulletin of each Faculty and Department. Please make sure to check that you understand the educational purposes and the structure of the faculty to which you belong.

【Curriculum Map】

A Curriculum Map illustrates the connection of offered courses to the educational purposes. Based on the Diploma Policy, it shows what courses cultivate the expected skills and knowledge upon graduation. The Curriculum Map of each Faculty and Department is shown on Loyola's Bulletin Board (University Bulletin Board). Please check to see how your registered courses relate to the Diploma Policy and use the information as a guide when making your academic plans. The relationship of courses and the Diploma Policy will also be shown on the syllabus.

【Curriculum Tree】

Curriculum Tree diagrams sequential and systematic relationships among course groups, in association with the Diploma Policy. Inclusion of the Diploma Policy, Curriculum Map and numbering factors in one diagram offers a comprehensive view of the sequential and systematic relationship among courses. This allows students to gain an overall image of the courses they should take and the sequence in which they should be taken in order to be awarded a degree. It is a tool for "visualizing learning outcomes" and to communicate what abilities students should acquire upon graduation.

3. Credits and Courses

● Credits

A certain number of credits are given for all courses; if you take the courses and pass the exams, you will earn the credits. The calculation method of credits varies depending on the type of course. The numbers of credits you may earn for the courses you register for are given in the “Bulletin of Information” in the sections for each Department or the sections of *Zengaku Kyotsu Kamoku* (General Studies courses) with lists of instructors.

The number of credits required for graduation varies depending on the Department and Matriculation Year. You must check the requirements on the sections of your Department “1. Courses and minimum number of credits required for graduation”, “2. Distribution of Required Credits”.

Based on government requirements of Standards for Establishment of Universities and Article 22 of Sophia University Regulations, “45 hours of study is required to earn one course credit”. This means that students are required to study a number of hours other than the actual class hours.

● Course Composition

Courses are divided into three main groups; General Studies (*Zengaku-Kyotsu-Kamoku*) courses offered by all Faculties, Language Courses offered by the Center for Language Education and Research and Specialized Education courses offered by each Department.

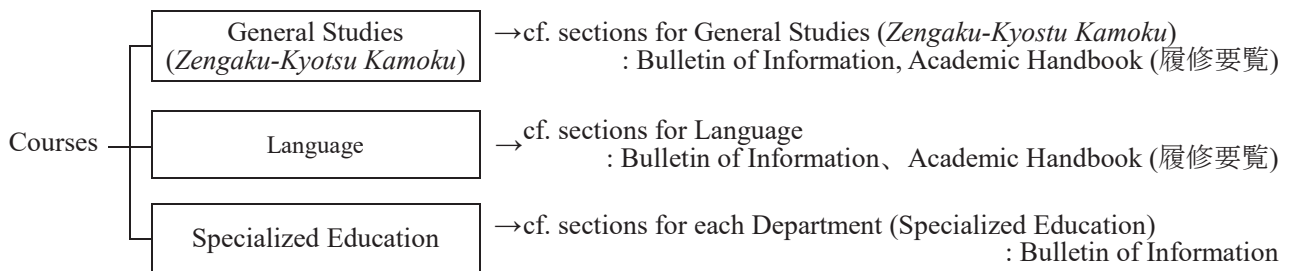

● Course Types

General Studies (*Zengaku-Kyotsu Kamoku*) and Specialized Education are divided into four categories

Compulsory courses	You must take these courses
Compulsory Elective	You may choose from several courses in this category to meet the credit requirements set by each Department
Electives	You may select the courses
Optional courses	You may take courses that interest you academically or personally (credits will not be counted into graduation requirements)

The credit requirements vary by Department. For more details see the sections for your Department in “1. Courses and minimum number of credits required for graduation” and “2. Distribution of Required Credits”

4. Numbering

Numbering is a system that classifies courses by giving appropriate numbers to show the level and order of learning and clearly indicates the curriculum system.

Numbering shows the fields of the course subject, the levels of learning, and the order in which courses should be taken. The Numbering system will be a useful guide to help students in planning course enrollment.

- 1) Courses to which Numbering applies: All undergraduate courses
Courses offered by all Faculties
- 2) Basic policy of Numbering

AAA 111 - 75 - e - 00

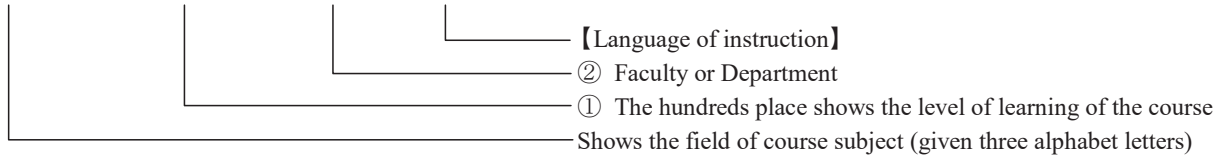

【Field of course subject】

Field (Alphabet)	Field	Field (Alphabet)	Field
THE	Theology	INL	International Law
RES	Religious Studies	PIL	Private International Law
PHL	Philosophy	ENL	Environmental Law
ART	Art History/Visual Culture	POL	Political Science
CUL	Culture	ECN	Economics
LIT	Literature	MAN	Management
JLT	Japanese Literature	ACC	Accounting
JAL	Japanese Language Studies	MRK	Marketing
CLT	Chinese literature	MMI	Miscellaneous
ELT	English Literature	SOC	Sociology
GLT	German Literature	SSV	Social Service
FLT	French Literature	PSY	Psychology
LNG	Linguistics	EDU	Education
LGG	Linguistics (German)	IBE	International Business and Economics
LGF	Linguistics (French)	IBD	International Business and Development Studies
LGH	Linguistics (Hispanic)	GST	Global Studies
LGR	Linguistics (Russian)	IRS	International Relations
LGP	Linguistics (Portuguese)	ICP	International Cooperation
LGC	Linguistics (Communication Disorders)	ARS	Area Studies
LGE	Linguistics (TESOL)	ASA	Area Studies (Asia)
LGJ	Linguistics (TJFL)	AME	Area Studies (Middle East)
ENG	English	AAF	Area Studies (Africa)
GMN	German	ANA	Area Studies (North America)
FRN	French	ALA	Area Studies (Latin America)
HSP	Hispanic	AEU	Area Studies (Europe)
CHN	Chinese	ARE	Area Studies (Russia and Eurasia)
KOR	Korean	JST	Japanese Studies
RUS	Russian	SCT	Science and Technology
POR	Portuguese	MLS	Materials and Life Sciences
ITL	Italian	EAS	Engineering and Applied Sciences
IND	Indonesia	ICS	Information and Communication Sciences
TGL	Filipino	MEC	Mechanical Engineering
ARA	Arabic	EEE	Electrical and Electronics Engineering
THA	Thai	ACH	Applied Chemistry

Field (Alphabet)	Field	Field (Alphabet)	Field
PER	Persian	CHM	Chemistry
CAM	Combidian	MTH	Mathematics
BUR	Burmese	PHY	Physics
TUR	Turkish	BIO	Biology
VIE	Vietnamese	INF	Informatics
HIN	Hindi	GRS	Green Science
SWA	Swahili	GRE	Green Engineering
JPN	Japanese	GSE	Green Science and Engineering
LAT	Latin	COM	Computer Studies
HST	History	NRS	Nursing
GEO	Geography	ENV	Environmental Studies
ANT	Anthropology	HPE	Health and Physical Education
JRN	Journalism	SCH	Studies in Christian Humanism
CUI	Cultural Interaction	RPH	Religion/Philosophy
HUM	Humanities	THP	Thinking Processes
LAW	Law in general	CMF	Composite Fields Studies
JUR	Jurisprudence	TCP	Teacher-training Course Program
PBL	Public Law	CCP	Curator Course Program
CVL	Civil Law	SEP	Social Engagement Program
CML	Commercial Law	GRP	Graduation Project
CPL	Civil Procedural Law	IDR	Independent Research
CRL	Criminal Law	SAC	Study Abroad Courses
SCL	Social Law		

【The levels classified by the hundreds place】

- 100's: Introductory level courses
- 200's: Courses that lead from the Basic to Specialized level
- 300's: Specialized level or courses for specialized knowledge that connects to society
- 400's: Courses for specialized areas (advanced levels, seminars in specialized area)

- The numbering policy of each Department is given on the pages for each Department in the points to note for course enrollment.

【Faculty and Departments number】

Faculty of Science and Technology Courses:	75
Department of Materials and Life Sciences:	76
Department of Engineering and Applied Sciences:	77
Department of Information and Communication Sciences:	78
Department of Journalism	19
Department of Education	81
Department of Sociology	83
Department of Economics	41
Department of Management	42
Department of Global Studies	21

【Language of instruction】

- j: Japanese
- e: English

- 3) The numbering is shown in the column next to the course code on the List of Courses and Instructors.

5. Course Registration

● Course Registration Schedule

Students must register for courses for Spring Semester (including 1st Quarter and 2nd Quarter) and Autumn Semester (including 3rd Quarter and 4th Quarter) on Loyola during the period set for course registration.

More information on procedures of Loyola and points to be noted about course registration are given in the “Loyola Handbook” online. Read it thoroughly to avoid registration errors.

■ Schedule for 2022 Spring Semester, 1st Quarter and 2nd Quarter Course Registration

	Academic event	Year level	Period	Notes
①	Course registration (Spring Semester, 1 st Quarter and 2 nd Quarter courses)	all students	April 1 (Fri) 10 : 00 ~ April 11 (Mon) by 9 : 00 (*Registration suspended from April 8 (Fri) 12 : 00 ~ April 9 (Sat) 14 : 00 for the process of lottery selection.)	To enroll in Spring Semester, 1 st Quarter and 2 nd Quarter courses (except for lottery courses) you must register on Loyola during this period.
②	Lottery entry	all students	April 1 (Fri) 10 : 00 ~ April 8 (Fri) by 12 : 00	To enroll in Spring Semester, 1 st Quarter and 2 nd Quarter lottery courses , you must submit your entries for lottery courses on Loyola during this period.
③	Results of lottery entry	all students	April 9 (Sat) 13 : 00 ~	May check lottery results of courses you entered for in period ②
④	Lottery course registration ※First-come-first-served basis (Spring Semester, 1 st Quarter and 2 nd Quarter courses)	all students	April 9 (Sat) 14 : 00 ~ April 11 (Mon) by 9 : 00	May make entries on Loyola, on a first-come-first-served basis, for courses that did not reach capacity.
⑤	Results of course registration available	all students	April 11 (Mon) 13 : 00 ~	May check results of course registration (registered for in periods ①, ② and ④) on Loyola
⑥	Course adjustment (Spring Semester, 1 st Quarter and 2 nd Quarter courses)	all students	April 12 (Tue) 10 : 00 ~ April 18 (Mon) by 21 : 00	May make adjustments to results of course registration on Loyola
⑦	Final confirmation of course registration (Spring Semester and 1 st Quarter final results)	all students	April 20 (Wed) 13 : 00 ~	Check results of course adjustments (made in periods ①, ②, ④ and ⑥) on Loyola
⑧	Withdrawal Period for 1 st Quarter courses	all students	May 2 (Mon) 10:00 ~ May 6 (Fri) by 18:00	For details, refer to p.32.
⑨	Extra course registration for 2 nd Quarter courses	all students	June 3 (Fri) 0:00 ~ June 9 (Thu) by 21:00	May add / cancel 2Q courses including (Lottery courses)
⑩	Withdrawal Period for courses in Spring Semester and 2 nd Quarter	all students	June 13 (Mon) 10 : 00 ~ June 17 (Fri) by 18 : 00	For details, refer to p.32.

■ Schedule for 2022 Autumn Semester, 3rd Quarter and 4th Quarter course registration

	Academic event	Year level	Period	Notes
①	Course registration (Autumn Semester, 3 rd Quarter and 4 th Quarter courses)	all students	Sep 21 (Wed) 10 : 00 ~ Sep 28 (Wed) by 21 : 00 (*Registration suspended from Sep 25 (Sun) 12 : 00 ~ Sep 26 (Mon) 14 : 00 for the process of lottery selection.)	To enroll in Autumn Semester, 3 rd Quarter and 4 th Quarter courses (except for lottery courses) you must register on Loyola during this period.
②	Lottery entry	all students	Sep 21 (Wed) 10 : 00 ~ Sep 25 (Sun) by 12 : 00	To enroll in Autumn Semester, 3 rd Quarter and 4 th Quarter lottery courses, you must submit your entries for lottery courses on Loyola during this period.
③	Results of lottery entry	all students	Sep 26 (Mon) 13 : 00 ~	May check lottery results of courses you entered for in period ②
④	Lottery course registration ※First-come-first-served basis (Autumn Semester, 3 rd Quarter and 4 th Quarter courses)	all students	Sep 26 (Mon) 14 : 00 ~ Sep 28 (Wed) by 21 : 00	May submit entries on Loyola, on a first-come-first-served basis, for courses that did not reach capacity.
⑤	Results of course registration available	all students	Sep 29 (Thu) 13:00 ~	May check results of course registration (registered for in periods ①, ② and ④) on Loyola

	Academic event	Year level	Period	Notes
⑥	Course adjustment (Autumn Semester, 3 rd Quarter and 4 th Quarter courses)	all students	Sep 30 (Fri) 10 : 00~ Oct 3 (Mon) by 21 : 00	May make adjustments to results of course registration on Loyola
⑦	Final confirmation of course registration (Autumn Semester and 3 rd Quarter · 4 th Quarter courses final results)	all students	Oct 5 (Wed) 13 : 00~	May check results of course adjustments (made in periods ①, ②, ④ and ⑥) on Loyola
⑧	Withdrawal Period for 3 rd Quarter courses	all students	Oct 18 (Tue) 10:00~ Oct 19 (Wed) by 18:00	For details, refer to p.32.
⑨	Extra course registration for 4 th Quarter courses	all students	Nov 18 (Fri) 0:00~ Nov 24 (Thu) by 21:00	May add / cancel 4Q courses including (Lottery courses)
⑩	Withdrawal Period for courses in Autumn semester and 4 th Quarter	all students	Nov 28 (Mon) 10 : 00~ Dec 1 (Thu) by 18 : 00	For details, refer to p.32.

● Course Registration

Course registration is the procedure for students to select the courses they intend to take (attend) and register for the courses within a given period. There are two separate course registration periods for lottery courses and non-lottery courses (for registration periods, see p.26).

If you make registration errors, you will not be allowed to take the courses you intended to and no grades or credits will be given; take extra caution when registering for courses. Please read the “[Loyola Handbook](#)” on Loyola thoroughly before registering.

To avoid registration errors, log in to Loyola again after the registration has been completed and check that all courses you wish to take are registered. It is recommended that students print out or save a copy of the registration screen.

Any notices or announcements on course registration will be posted on the Loyola Bulletin Board (Academic Services).

● Limit on Number of Credits per Semester / Year

There is an upper limit on the number of credits a student may register for in a semester and in a year (maximum credit limit), so that the students will be able to have sufficient study hours to earn the credits and maintain the academic level of their studies.

Maximum credit limits differ depending on the Department.

FST: Please see p.81 for Green Science, p.91 and 92 for Green Engineering, “Limit on the Number of Credits per Year / Semester”.

SPSF: Please see p.105, “Limit on the Number of Credits per Semester for all SPSF students”.

- ※ The maximum credit limit is the upper limit of credits a student may register. It includes courses attempted for which he/she did not earn credits (courses the student withdrew from (W) and courses that were given a grade of F).
- ※ When the sum Spring Semester upper limit and Autumn Semester upper limit is greater than Annual maximum credit limit, you can register up to Annual limit only.

■ Example of maximum credit limit

Autumn	Spring	Annual
26	27	49

If a student registered 26 credits in the Autumn Semester

→ In Spring Semester, the student is allowed to register only up to the annual limit.

Annual maximum credit limit (49 credits) – Spring Semester (26 credits) = 23 credits

The above calculation is only an example. Please thoroughly read the pages of your Department to create your annual course enrollment plan.

● Repetition of a Course

If a student repeats the same course it will not be approved as credit required for graduation.

Repetition of the same course generally means courses with the same course code number.

In general, it is not allowed to take a course for which a student has already earned credits, but there are some exceptions.

For more information, refer to the sections for each Faculty/Department and for General Studies (*Zengaku-Kyotsu Kamoku*) courses.

● Lottery Courses

Lottery courses are courses with limited class capacities.

The class capacity is shown in the Notes column as “number of students” on the List of Courses and Instructors.

If you wish to take a lottery course, students must register on Loyola during the Lottery Registration of each semester and quarter.

The lottery is conducted by computer and the successful students will automatically be registered for the course.

If you are selected for a lottery course, you may delete the registration for the successful course during the course registration period or the course adjustment period.

For details, see Loyola Bulletin Board/University Bulletin Board.

■ Registration procedures for lottery courses

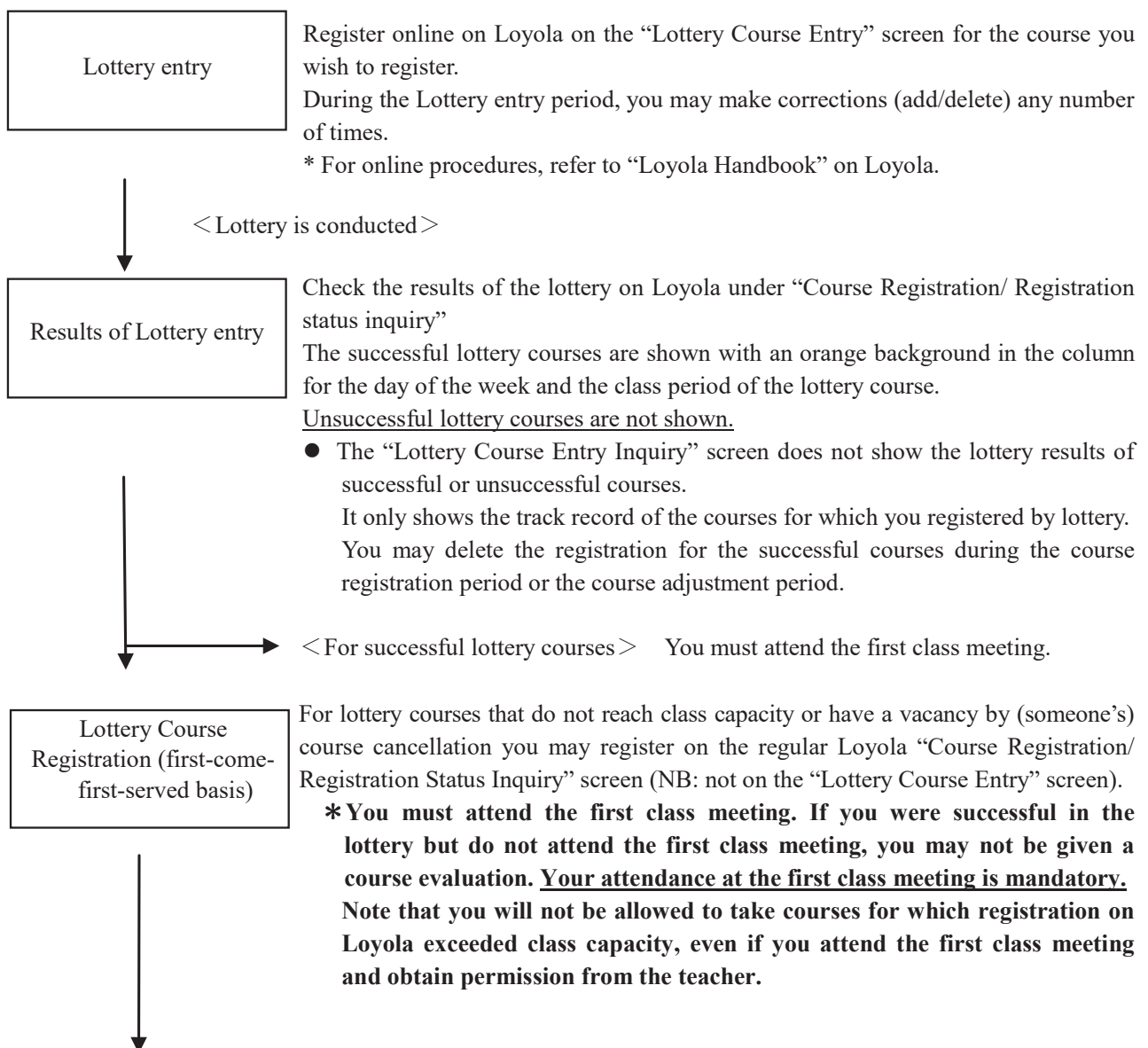

You may delete the registration for the successful courses during the course registration period or the course adjustment period.

Final Confirmation of
Course Registration
including lottery courses

Make sure to check the final results of course registration on Loyola on the “Course Registration/ Registration Status Inquiry” screen.

* When should you check the course registration results:

(1) during Course Adjustment

(2) during Final Confirmation of Course Registration

Check Loyola on the “Course Registration/ Registration Status Inquiry” screen.

If you have any questions, please come to the Center for Academic Affairs during the above period.

* If errors occur in the lottery (ex. limit of maximum credits per year, etc.), the details of the errors are shown on the Lottery Course Entry screen.

* Limit on number credits

Freshman can only register 4 credits of University wide General Studies elective courses in one semester. Please note that no more than 4 credits (not number of courses) can be registered, either through lottery selection and first-come-first served basis registration.

● Points to Note on Course Registration

- Point to note on Course Registration procedures
 - For Course Registration procedures, read carefully “Loyola Handbook” (access also available from Loyola menu). New students should also read “Course Registration Quick Navi”.
 - Course Registration on Loyola should be completed by the final deadline time on the last day of course registration. (Registration is completed when you click the “Complete Registration” button on the “Course Registration/ Registration Status Inquiry” screen). Note carefully that, your registration is not completed unless you click the “Complete Registration” button by the final deadline time. No special arrangements will be made for anyone who fails to register for courses due to problems with computers or communications environment on the final registration deadline day. Make sure to allow enough time to complete your registration.
 - On the final day of registration, internet congestion is anticipated. Try to complete your registration earlier, if possible one day prior to the deadline. During the Course Registration period, you are allowed to make corrections (add/delete) any number of times even after you have clicked the “Complete Registration” button.
 - After completing your course registration, make sure to check for any errors in registered courses during the registration period. When you click the “Complete Registration” button and you do not make any further changes before the final deadline time, this will be registered as final.
 - We recommend that you print out the final screen of the “Course Registration/ Registration Status Inquiry” or copy and save the screen data. To print it out, click the “Complete Registration” button, log out once and then login again; print out this screen.

6. Enrollment in Courses Offered by Faculty of Liberal Arts

● Application Procedure for Course Enrollment

【SPSF】 SPSF Students may register for most courses offered by the Faculty of Liberal Arts except for FLA Core Program courses on Loyola.

【FST】 Students of the Faculty of Science and Technology, Program in English, may register for most of the 100 and 200 level courses offered by the Faculty of Liberal Arts on Loyola. However, students who wish to register for 300 and 400 level courses should submit “FLA Course Registration Form” to the Center for Academic Affairs following the instruction below;

< Registration procedures >

- ① During the Course Registration period, download “FLA Course Registration Form” and Course Schedule from the Loyola Bulletin Board (Academic Services) and make your course enrollment plan. To select the courses you wish to enroll in, check the syllabus on Loyola (check the prerequisites, repeatable/unrepeatable status and if the credits can be counted toward graduation requirement or not). Also make sure to check “Other departments’ students” and if “No”, the course can not be registered.
- ② Fill out “FLA Course Registration Form” and submit to the Center for Academic Affairs during the registration period.
- ③ Confirm if the course(s) is(are) registered correctly on Loyola.

Important Notice

- 1) Following courses are compulsory for degree students of the Faculty of Liberal Arts. Students of other faculties and programs cannot register.

ENG110 ACADEMIC ENGLISH SKILLS
 ENG111 ENGLISH COMPOSITION 1
 ENG112 ENGLISH COMPOSITION 2
 ENG115 PUBLIC SPEAKING
 THP101 THINKING PROCESSES
 INF100 OVERVIEW OF DATA SCIENCE

- 2) Students who wish to register the 400 level courses of ANT or SOC must have completed one or more of the following prerequisite courses.
ANT310, ANT317, ANT318, ANT319, SOC312, SOC315, SOC316
- 3) No addition or cancellation of courses will be accepted once the application form is submitted. If you wish to stop taking the course, you may withdraw from the course during the withdrawal period.
- 4) Lottery courses are prioritized for FLA students. Students of other faculties and programs may be able to register for only the courses with openings.
- 5) Courses registered on Loyola are given priority in course registration. Therefore, your registration requests will be invalid if there is a course conflicts between the courses registered via Loyola and your registration form.
- 6) The credits of the FLA course will be included in the limit on number of credits per semester or year. The course will not be registered if the number of credits would exceed the limit by registering a FLA course.

● Summer Session in East Asian Studies

Students may take Summer Session in East Asian Studies courses offered by the Center for Global Education and Discovery. Summer Session courses are not counted into maximum credit limits per semester or year. More information on registration procedures and programs will be posted on the Loyola Bulletin Board (Academic Services) in April.

Students must refer to the up-to-date information posted on the website below.
sophia.ac.jp/eng/admissions/short-term

7. Course Withdrawal

● Withdrawal from Courses

If a student decides after the registration period not to finish a course for which he/she has registered, the student should apply to withdraw from the course online (Loyola). A “W” means that the student has asked for and obtained permission to withdraw from the course. This mark will remain permanently on the student’s record, but will not appear on the official transcript. If a student discontinues attending a course and does not complete withdrawal online during the withdrawal period, he/she will receive an “F” for the course. The grade of “W” will not be calculated into the student’s GPA, but an “F” will.

■ Withdrawal Period

Semester and Quarter	Period	Results of Withdrawal available
• For 1st Quarter courses	May 2 (Mon) 10:00~ May 6 (Fri) 18:00	May 10 (Tue) 10:00~
• For Spring Semester courses and 2nd Quarter courses	June 13 (Mon) 10:00~ June 17 (Fri) 18:00	June 21 (Tue) 10:00~
• For 3rd Quarter courses	Oct 18 (Tue) 10:00~ Oct 19 (Wed) 18:00	Oct 21 (Fri) 10:00~
• For Autumn Semester courses and 4th Quarter courses	Nov 28 (Mon) 10:00~ Dec 1 (Thu) 18:00	Dec 5 (Mon) 10:00~

● Points to Note on Course Withdrawal

■ Courses from which you are not allowed to withdraw:

- ① Compulsory courses (both General Education and Specialized Education courses)
- ② Language courses (for exceptions, refer to 【Request by “Course Withdrawal Request”】)
- ③ Teaching practice / curator practice courses
- ④ Courses with class sessions that end before the Course Withdrawal period.

Note that some Departments have courses other than compulsory courses from which you are not allowed to withdraw or some have compulsory courses from which you are allowed to withdraw.

Check the rules for each Department in “Points to note on course enrollment”.

■ Seniors should check carefully whether they have registered for a total of credits and courses to satisfy all graduation requirements.

■ Course withdrawals or cancellation of withdrawals are not allowed outside of the Course Withdrawal period.

During the Course Withdrawal period, you may cancel course withdrawals on Loyola; after the designated period, no cancellations or additional course withdrawals are possible. If you wish to withdraw from a course, allow enough time to submit a request for withdrawal during the designated period. You may register again in the following or later academic years for the course from which you withdrew.

■ You may withdraw from lottery courses

If you are successful in a lottery course but wish to withdraw from the course, you may do so on Loyola. (You are not allowed to withdraw from compulsory courses and some other courses.)

■Credits included in maximum credit limit

The credits of courses you withdraw from are counted into the maximum credit limit for a semester or a year.

If you register for courses offered in the Autumn Semester, be sure to include the credits in your enrollment plan within the maximum credit limit.

■Check courses withdrawn

No cancellations or additional course withdrawals will be accepted after the Course Withdrawal period. To avoid any errors in the withdrawal procedures, make sure to login to Loyola again to check after you complete your course withdrawal procedures. We recommend that you keep a copy of the screen.

● Request by “Course Withdrawal Request” Forms

The 2021 “Course Withdrawal Request” forms will be given out and submission accepted during the following periods:

Semester and Quarter	Submission Period	Results available
1st Quarter	May 2(Mon)10:00-May 6(Fri)15:30	May 10(Tue)10:00-
Spring Semester and 2nd Quarter	June 13(Mon)10:00-June 17(Fri)15:30	June 21(Tue)10:00-
3rd Quarter	October 18(Tue)10:00-October 19(Wed)15:30	October 21(Fri)10:00-
Autumn Semester and 4th Quarter	November 28(Mon)10:00-December 1(Thu)15:30	December 5(Mon)10:00-

If the results of your “Course Withdrawal Request” are not shown on Loyola during the given period, immediately inquire at the Center for Academic Affairs (Academic Services).

※The office is open weekdays only; closed from 11:30 to 12:30.

■Courses that require submission of Course Withdrawal Request

Specialized Education

【For FST students】

GRADUATION RESEARCH 1・2 / SEMINAR 1・2

* The approval of the Department Chair is required for the above courses. Without the approval signature/seal of the Department Chair on the request form, it will not be accepted even if it is submitted during the submission period.

Foreign Language courses

Course withdrawals for foreign language courses will only be accepted by submitting “Course Withdrawal Request” in the following cases. However, we need to check in advance whether or not withdrawal is allowed for the particular course. Bring a printout of the Loyola Course Grades Inquiry screen during the submission period and inquire at the section for Foreign Language courses at the Center for Academic Affairs.

- ① If students are changing the language to be taken as Compulsory electives courses.(only for Journalism)
- ② If the total number of credits exceeds the languages requirement with the submission of “Application of Credits for Overseas Short-term Language Programs”.

*In case of ①②, students will no longer be able to the language they withdraw from as Compulsory elective courses in the following semesters.

*Case② will only be accepted, if the application and the credits have been approved, Request form will not be accepted if students have yet to apply for or are awaiting approval.

8. Examinations

● Types of Examinations

Examinations are held during or at the end of term in Spring and Autumn Semesters in the following types:

Type of exam	Exam period / deadline of submission	Announcements of schedule etc.	Make-up exam	Notes
In-class Examinations	Any time during class sessions (usually on the last day of class)	Given in class by the class teacher	Not applicable	Foreign Language courses usually have in-class exams
Final Examinations (written tests)	During Final Exam period	Announced on Loyola by the Center for Academic Affairs (see below for schedule)	Applicable	General information is announced on the Loyola Bulletin Board; note that the class teacher may give additional instructions in class.
Final papers	To be submitted by the deadline set at the end of the term		Not applicable	

● Announcement of Schedule of Final Exams (Written Exams)/Report Exams

Information on “Final Exams (written exams)” and “Report Exams” will be announced on Loyola by the Center for Academic Affairs as follows;

Information on In-class Exams will be announced as “Other Exams”

< Semester Courses >

	Schedule announced on:	Final Exams (written exams) period
Spring Semester	Saturday, July 9, 2022	Saturday, July 23, 2022 – Saturday, July 30, 2022
Autumn Semester	Tuesday, Jan 10, 2023	Tuesday, Jan 24, 2023 – Tuesday, Jan 31, 2023

< Quarter Courses >

	Schedule announced on:	Final Exams (written exams) period
1st Quarter	Saturday, May 14, 2022	Saturday, May 28 and Saturday, June 4, 2022
2nd Quarter	Saturday, July 9, 2022	Saturday, July 23 – Saturday, July 30, 2022
3rd Quarter	Saturday, Oct 29, 2022	Saturday, Nov 12 and Saturday, Nov 19, 2022
4th Quarter	Tuesday, Jan 10, 2023	Tuesday, Jan 24 – Tuesday, Jan 31, 2023

● Examinations (Written Exams) Policy

- Note the following for taking the exams:
 - Check the exam room on Loyola. It is the student’s responsibility to check and to be at the prescribed exam room (note that the exam room may be different from the room where classes are normally held).
Mobile phones and wearable devices must be turned off and put inside a bag. It is not allowed to use such devices as clocks to check the time.
 - If you are more than 20 minutes late for the exam, you are not allowed to take the exam regardless of the reasons. The scheduled exam hours will not be extended for any reason including delay of public transport service. Allow enough time to arrive on time to the exam.
 - Students are not allowed to leave the class room for the first 30 minutes and the last 10 minutes of the exam.
 - No student may leave the classroom unless he/she has submitted his/her answer sheet.
 - If a student does not follow the instructions of the proctor or does not observe warnings to stop talking or any other misconduct, his/her exam shall be invalid.
- Things to bring to the exam
 - 1) Student ID Card: it must be placed on the desk. Without the Student ID Card, students will not be allowed to take the exam, regardless of the reasons.
 - ※ If you forget your Student ID Card, you may have a “Temporary Student ID Card” issued at the Automatic Certificate Issuance Machine located on 4th floor of Building No.2 (500

yen fee charged valid for the day of issue only). However, if you cannot be at the exam room with the “Temporary Student ID Card” within 20 minutes after the start of the exam, you will be considered late for the exam and will not be allowed to take the final exam.

- 2) Pens/pencils
- 3) Underlay Pad : Only if you need to use one; white or any similar color. Using a notebook or a book as an underlay is not permitted.

- Answer sheets
 - Students are given only one answer sheet. Papers other than the given answer sheet are not valid.
 - If a student makes errors on the answer sheet and a new answer sheet is given, he/she must return the first answer sheet.
 - Use a ballpoint or felt pen to fill in your Student ID Number and name. Answer sheets without student ID numbers or names are invalid

● **Cheating on Final Exams (written tests) is Strictly Prohibited**

Do not be tempted to cheat on written examinations. If a student is found cheating in an exam or violating an exam policy, the University will impose severe punishment. Honest performance is also expected at in-class exams held during class sessions. The following are some actions that would be considered cheating:

Disciplinary Standards Concerning Misconducts

Examples of Misconducts	Disciplinary Measures and Measures Concerning Enrolled Courses
<p>1. Misconducts in Final Examinations (including Make-up Examinations)</p> <ol style="list-style-type: none"> 1) Possessing mobile phones etc. in locations and/or in conditions that do not conform with the instructions. *Mobile phones etc. includes, smartphones, PHSs, PCs, mobile PCs, tablets, such electronic devices as smartwatches that have communications functions, wireless earphones, and such mobile recording devices as mobile music players. 2) Referring to documents and notes other than those explicitly permitted by the instructions, or referring to the devices listed in 1) above (this includes situations in which the student could have referred to such devices, regardless of whether they actually referred to them). 3) Failing to submit the exams and/or taking them away. 4) Referring to notes written on the desk, clothes, walls, and body etc., and/or taking the exam under such conditions. 5) Referring to other students’ exam answers, and/or trying to refer to them. 6) Exchanging documents etc. that were permitted for reference during the exam to/from other students. 7) Such distracting conducts as chatting. 8) Seeing and/or showing exam answers with other students. 9) Exchanging the exam answers with other students, and/or with exam answers that were prepared ahead of the exam. 10) Taking the exam for another student, and /or asking another person to take the exam. 11) Misusing the student ID card. <p>2. Misconducts in In-class Examinations and Report Examinations (including Final Papers)</p> <ol style="list-style-type: none"> 1) Misconducts in In-class exams that take place in lieu of Final exams. * For concrete examples, see 1. above. 2) Plagiarism in Report exams that take place in lieu of Final Exams, including in Final papers. 3) Writing reports or papers for another student, and/or asking someone else to write reports or papers. 4) To use a part of, or the entire report that has been submitted for another course (self plagiarism). 5) Other misconducts that jeopardize the fair and honest implementation of the Report exam. <p>3. Failing to obey the instructions for the investigation related to all the items listed in 1. and 2. above.</p>	<p>In accordance with Article 60 of Sophia University Regulation, misconducts are punished by dismissal, suspension, or reprimand.</p> <ol style="list-style-type: none"> 1) The grade “F” will be entered on the student’s record for the course in which the misconduct took place. 2) In case of suspension, the suspended period will not be counted in the residence requirement and graduation will be delayed. 3) In addition to the above, the student’s grades for the courses taken in the same semester may also become “F.”
<p>◆ Disciplinary measures take effect as from the day when the misconduct took place.</p>	

Cheating in written exams involves more than the grade for that one course; it causes a far greater disadvantage for the student involved. Cheating in exams may be an impulse; do not give in to temptation--it has grave consequences. Double check the materials you are allowed to bring into an exam, if any, on Loyola before taking an exam.

● If Public Transport Service is Shut Down

Refer to “If Public Transport Service is Shut Down” (p.16) in “Common Guidelines”.

● Make-up Exams

If students were unable to take the Final Exams held during the final exams week for the following reasons, they may be allowed to take make-up exams by submitting an “Application for Make-up Exams” (form available). To take the make-up exams, the students will need to submit an application for make-up exams during the given period, obtain permission, and pay the make-up exam fees.

No application for make - up examination for Courses that held in - class exams (outside the Final Exams period) is accepted.

1) Legitimate reasons for applying for make-up exams

The legitimate reasons include illness, family emergency of third degree of kinship, disasters, delay in public transport service, and appointment to lay judge system. The application for make-up exams must be accompanied by the following supporting documents to prove that the student was unable to come on the day of the final exam(s). The application procedure must be completed within the specified period.

2) Supporting documents and procedures

When applying for a make-up exam, bring the necessary supporting documents (see below) and a print-out of the Loyola final exam inquiry screen.

1. “Illness”	Medical certificate or permission to return to school issued by a physician (university designated form) ※ Payment receipts are not accepted
--------------	---

The medical certificate must state all of the following:

- The name of the illness and a statement by the physician attesting that the student was not in a condition to take an exam on the day of the exam.
- Clear statement showing that the student was unable to come to the exam because of scheduled the consultation or because the student was undergoing treatment.
※ If the student had to be absent over several days, the medical certificate must clearly show that these days include the consultation day or the treatment period.

If the medical certificate does not state both a) and b), it will be deemed an incomplete and the student will not be able to apply for a make-up exam.

*In the case of an infectious disease, application for the make-up exam(s) must also be filed during the designated application period for the make-up exams. If a student is unable to come to campus due to the infectious disease, please contact the Center for Academic Affairs before the end of the application period.

2. “Bereavement involving third degree of kinship”	Funeral service card/thank you card etc. addressed to funeral guests
--	--

The cards must show the date of the exam the student was unable to take.

※The travel days will not be applicable to make-up exams.

3. “Delay in public transport service”	Delay certificates issued by the public transport service (indicating the date and the delayed time); a delay certificate printed out from the Internet is also acceptable.
--	---

If the delay in public transport service was 20 minutes or more and a student arrived at the exam more than 20 minutes past the scheduled starting time, they may apply for a make-up exam.

However, the application must be filed on the very day of the delay.

※ Note: Applications for make-up exams will not be accepted on the day following the exam day or later.

NB If a student is unable to come to the university on the day of the delay for unavoidable reasons, shutdown of public transport service, or a long distance commuting, a “tentative application” must be made by telephone to the Center for Academic Affairs, Make-up Exams section (Tel: 03-3238-3515) before 17:00 on the day of the delay (for exams held on 5th-6th class periods, before the end of the exam time). If the student fails to make the “tentative application” during the above period, or if a proper application is not made following the “tentative

application” during specified period, he/she will not be allowed to apply for a make-up exam whatever of the reasons may be.

- ※ Only delays occurring on a student’s normal commuting route between his/her home and the university will be accepted (not accepted if the route is other than from home). The Center for Academic Affairs will check the address given on the “Enrollment Sticker” on the back of the Student ID Card before accepting the application for the make-up exam.
- ※ The delay certificate must show a delay longer than the actual length of the student’s delay. (e.g. if the student arrived 30 minutes past the scheduled exam starting time, the delay certificate must prove a delay of more than 30 minutes); applications for make-up exams will not be accepted if the student came to the university intending in the first place to arrive late for the exam.
- ※ A proxy applications submitted by someone other than the student himself/herself will not be accepted for reasons of delay in public transport service.

<<If a student comes late to the exam because of a delay in public transport service, the student should take one of the following steps depending on the length of the delay>>

- (1) If a student arrives within 20 minutes of the scheduled exam starting time:
If the delay is less than 20 minutes, he/she is allowed to take the exam; go straight to the classroom and take the exam.
- (2) If a student arrives more than 20 minutes after the starting of the scheduled exam:
Bring the delay certificate and go immediately to the Center for Academic Affairs (Academic Services) on 1st floor, Bldg. No.2.; have the arrival time checked; submit the delay certificate and a apply for then make - up exam.
★ If it is difficult to decide yourself, go first to the exam room and follow the instructions of the exam supervisor.

If the reason for applying for a make - up exam is “natural disaster”, “selection by lay judge system” or some other reasons, please inquire at the Center for Academic Affairs, Make-up Exam section, for more information on the application procedures.

3) **Make-up exam fee:** 2,000 yen per course

4) **Make-up exam schedule:** Schedule will be announced on the Loyola Bulletin Board for the Center for Academic Affairs (Academic Services).

	2022 Spring Semester and 2nd Quarter	2022 Autumn Semester and 4th Quarter
Make-up exam application period (submission period of Application for Make-up Exam)	During the Spring Semester Final Exams (late July)	During the Autumn Semester Final Exams (late January)
Payment period of Make-up Exam fee	Late July to early August	Late January to early February
Announcement of Make-up Exams schedule (Loyola)	Late August	Mid- February
Dates of Make-up Exams	Late August ※Students cannot choose make-up exam dates	Mid-February ※Students cannot choose make-up exam dates

The schedule of make-up exam application period and points to be noted will be announced before the Final Examinations on Loyola; Any disadvantages that may arise from failure to check the Loyola Bulletin Boards will be the responsibility of the individual student. Please make sure to check the announcements.

※The details of 1st Quarter and 3rd Quarter Make-up Exams will be announced on Loyola.

● **Cheating on Report Exams is Strictly Prohibited**

Never be tempted to cheat or commit any other misconduct in report exams. If a student is found cheating or committing any misconduct, the University will impose severe punishment.

[Cheating on report exams involves:]

- Using sentences (block quotations) quoted from books, materials, or internet websites in your report without citing the sources and pretending that you wrote the sentences. (Plagiarism)
- Using reports that another student (your senior or friend) wrote for the said course or a similar

course in the past and presenting it as your own report.

[Misconduct in report exams involves:]

- Writing a report for a course and using the same report to submit for another course.

If the above misconduct is found in the report exam, your class teacher will give the grade F (fail) for the course and you may be summoned and given a severe warning. In addition, the University may apply the same punishment as in cheating on final exams. (cf. p.35)

Cheating or misconduct in report exams sometimes occurs unintentionally and may well be avoided if a student takes a more cautious stance. Read the “Stance on Exams, Reports and Papers” thoroughly to prevent misconduct and comply with the policy of “Academic Honesty”.

● Stance on Exams, Reports and Papers

◆ To promote “Academic Honesty” and to comply with its policy

As the name Sophia indicates, Sophia University respects wisdom in its ultimate form. We ask the students to cultivate an attitude of Academic Honesty based on the following two points; Sophia lays emphasis on its educational principles of respecting others and cooperating with others based on the concept of “Men and Women for Others, with Others”.

(1) Students should respect the research and source of information of their forerunners and contemporaries and conduct independent and in-depth study.
--

(2) Students should make continued efforts to enhance their basic academic skills.
--

By observing these points, students will be able to avoid committing acts of academic dishonesty such as breaking research rules (falsifying and fabrication of data) simply because they wish to be academically creative, or giving off research results of others as your own, or also unintentional plagiarism. All these are acts opposed to Academic Honesty.

Final exams are conducted so that a student can check how much he/she has achieved in the studies (written exams or reports). We expect students to be as honest and sincere in the exams as they always are in class. Dishonest acts such as cheating on exams and falsifying reports shall be severely punished. We ask the students to act with respect for wisdom in various scenarios with the Sophian stance of respecting wisdom.

◆ Rules for quotations in reports and papers

To evaluate your class work and give grades, teachers may ask you to hand in reports or papers. When writing the reports or papers, you will need to give your final comments and ideas on analysis. Your ideas and comments should not be limited to self-centered views, so you must learn from the various research conducted in the past and the present and build your research upon these. When writing reports and papers, the following points should be noted.

- 1) If the concepts and ideas, tables and charts that a student uses in the reports and papers are taken from literature, materials or websites, he/she must indicate the exact parts of the literature, materials or websites used.
- 2) If quoting directly from literature, materials, or websites, a student must show that they are quoted by placing the phrases in quotation marks, and cite the exact source.
- 3) Needless to say, a student must write his/her own reports and papers; you must never present reports written by friends, senior students, or family members as your own.
- 4) To use a part of, or the entire report that has been submitted for another course (self plagiarism) is also a misconduct.

If someone you know or a total stranger gives off the essay or paper you wrote as his/her own, what would your reaction be? Citing quotation and references protects the rights of the author, and it is simply a matter of academic manners and ethics for all involved in research and studies. If a student fails to observe the above 1), 2), and does not cite the quotation or show where the ideas were taken from in the literature or materials, the use of the written contents will be considered as data theft or plagiarism. Overseas, this “plagiarism” is strongly rebuked and unintentional copying and pasting of materials from reference literature or websites are considered as plagiarism. If a student gives off papers written by another person as his/her own as stated in 3), this is an act of fraud. If you are found performing such act or data theft or found to have reused papers that you have wrote for other courses and purposes, you will be subject to severe punishment and warnings similar to those when found cheating on written examinations. When using quotations or references, observe the following two important rules:

- ▼ (1) If you use quotations or references from books or websites in your report or paper, place footnotes and cite the sources. The styles of quotation citing are different in academic fields; you should ask your instructor for the details. Generally the following information should be given. When quoting from:
 - ◇ books: author, “title of book”, publisher, year of publication, pages quoted
 - ◇ papers in journals: author, ‘title of paper’, “title of journal”, Vol. ○, No.△, year of publication, pages quoted
 - ◇ website: creator, “name of site or article”, <URL http://www. ○○○. △△△>
date you visited the site: year, month, day (or latest updated on-year, month, day)
- ▼ (2) If you need to quote directly from materials written by someone else in your report or paper, put the quoted sentences in quotation marks to make it clear that the quoted sentences are not written by you.
 - ◇ Example for quoting directly in your report/paper:
“(your sentences) the author, Jochi Taro, writes on this subject “(quoted sentences) the meaning of the existence of university should be viewed from three perspectives . . .”
(author: Jochi Taro, year published 20xx, page quoted p.xxx)

The University level quotations must be cited accurately to show exactly who conducted the quoted research and what the results on which you base your research and analysis were. As shown, clear and accurate citing of quotations and references are expected in the practice of Academic Honesty.

9. Evaluation / Grades

● Evaluation Criteria

Academic performance is evaluated by the class teachers according to their teaching and evaluation policies based on results of exams (written, oral, practical), reports and class attendance.

Grading and evaluation criteria are as follows:

		grade	points	QPI	criteria
evaluated	pass	A	100~90	4.0	EXCELLENT
		B	89~80	3.0	GOOD
		C	79~70	2.0	SATISFACTORY
		D	69~60	1.0	PASSING
		P	——	—	PASSING
	fail	F	59 or below	0	FAILURE (did not show results satisfying passing level in a course with passing grades of “A”, “B”, “C”, “D”)
		X	——	—	NOT PASSING (did not show results satisfying passing level in a course with passing grade of “P”)
not evaluated	Withdrawal	W	——	—	Withdrew from course during designated course withdrawal period
	Transfer credits approved	N	——	—	TRANSFERRED FROM OTHER UNIVERSITIES (Approved as credits equivalent to those earned at Sophia)

※“W” will not appear on the official transcript.

The following “Grading Guideline” has been implemented by the university from the academic year 2015. The grades should be determined according to this guideline.

【The Grading Guideline】

An “A” should be given to approximately 20% and no more than 30% of the registered students. This policy, however, does not apply to seminars, guidance courses, and lecture courses with registered Students of 30 or less.

Although each course should be graded according to the evaluation criteria indicated in the course syllabus, professors should apply a grading curve to limit the number of A’s to no more than 30% of the students in the course. As a result, when more than 30% of the students receive a raw score of 90 points (out of 100), those students outside the top 30% would receive a lower grade for the course.

● G.P.A. (Grade Point Average)

The Quality Point Index (=QPI: see above list) multiplied by the number of credits for the course determines the quality points (QP) for that course. The sum of all the quality points divided by the total number of credits attempted (excluding courses with grades W, N, P, X) gives the grade point average (GPA). W (withdrawn from course), N (approved course), P (passing), X (failing) are not included in the calculation.

【GPA calculation formula】

$$4.0 \times \text{credits with A} + 3.0 \times \text{credits with B} + 2.0 \times \text{credits with C} + 1.0 \times \text{credits with D}$$

—————
The sum of all the registered courses (excludes courses with W, N, P, X)

● Grades Release Dates

The grades for Academic Year 2022 will be released as follows:

Courses	Year in school	Release period	Released via
Cumulative grades including Spring Semester, 1st Quarter and 2nd Quarter	4th year	Aug 25 (Thu) ~	Loyola "Grades Inquiry"
	3rd year	Sep 10 (Sat) ~	
	2nd year		
	1st year		
Cumulative grades including Autumn Semester, 3rd Quarter and 4th Quarter	4th year	Feb 22 (Wed) ~	
	3rd year	Mar 15 (Wed) ~	
	2nd year		
	1st year		

● Request for Grade Review

If a student believes there has been a mistake in the grades, he/she may submit a "Request for Grade Review" to the Center for Academic Affairs. No late requests will be accepted after the deadline.

Courses	Deadline for submission
2022 Spring Semester, 1st and 2nd Quarter courses	September 14 (Wed), 2022 15:30
2022 Autumn Semester, 3rd and 4th Quarter courses	March 22 (Wed), 2023 15:30

* For the seniors, there is a separate application period set in each Semester. For the schedule check the Loyola Bulletin Board (Academic Services).

If you intend to submit the request, consider carefully your reasons in light of the course contents and the grading criteria of A to F; read and follow the instructions given out from Center of Academic Affairs.

The following reasons will not be acceptable for submitting a Request for Grade Review:

- ① simply requesting for a re-evaluation and re-grading.
- ② asking the teacher to be lenient (affects your prospective graduation or acquisition of teacher's license etc.)
- ③ complaints based on comparison with other students (your friend had a grade B and you don't understand why you have a C, etc.)
- ④ you do not question the grading itself, but ask for the reason (ask the teacher for feedback, comment, disclosure of exam scores, etc.)
- ⑤ you have only non-specific statements such as "I attended the classes", "I took the exam" etc.

● Guidance for the Students Whose GPA is Less Than 0.5

According to Article 40 of University Regulations, students who fail to obtain 32 credits or more in two consecutive academic years shall be dismissed from the university.

To avoid such case, the department individually contacts the students whose GPA is less than 0.5 and give guidance at the end of the academic year.

This system is to give a chance to the students to look back their school life and study plan, and consult faculty staff on their future academic plan. In case the students do not show any improvement on their motivation after the guidance, the university may recommend withdrawal from the university.

For students with any academic problems or physical or mental distress, the university provides consultation throughout the year by not only faculty staff but also counselors and department staff. If you wish to consult, visit the university's official website → "Campus Life" → "Student Support" → "Student Consultation Services".

● Students with no Prospects of Academic Progress

Students who fail to earn a total of 32 credits or more in courses specified by the Departments in two consecutive years (NB) shall be dismissed from the university. For more information, refer to Academic Handbook (履修要覧) (administrative bylaws, Section 1, Article 40, University Regulations),

(NB) Two consecutive years are as follows:

Faculty of Liberal Arts, Faculty of Science and Technology English Course, SPSF				
Four consecutive semesters excluding periods of leave of absence				
(Example) If student takes leave of absence in 4Q of the year prior to the preceding year and in 1Q of the current year.				
	Spring		Autumn	
	1Q	2Q	3Q	4Q
Year prior to preceding year	● enrolled	● enrolled	enrolled	leave of absence
Preceding year	● enrolled	● enrolled	● enrolled	● enrolled
Current year	leave of absence	enrolled	● enrolled	● enrolled
※two consecutive years are the four semesters with the ● mark				

When calculating the credits, pay attention to the following:

- Credits are calculated by adding the credits obtained in two consecutive years. For students of the Faculty of Theology, Humanities Human Sciences, Law, Economics, Foreign Studies, Global Studies and Science and Technology (excluding English Course), the credits obtained in the academic year in which the leave of absence took place are not included in the calculation.
- For re-admitted students and second degree students, only the number of enrollment years and credits obtained after they re-entered or were admitted as second degree students will be calculated.
- For transfer students, the number of enrollment years and transfer credits which were approved at transfer admission will be included in the calculation.
- If a study abroad period exceeds one year, the period exceeding a year will be deemed a period of leave of absence.
- Credits obtained during study abroad approved within the consecutive two years will be included in the calculation.

N.B. Preferential Measures

Upon deliberation by the faculty meeting and with an approval of the President, a student who is in the third year or above, and who has taken less than 32 credits in four consecutive semesters excluding the period(s) of leave of absence, may be exempted from dismissal from the University by Article 40, if the total number of credits earned divided by the number of semesters of enrollment is more than 8 credits.

10. Graduation Requirements, Self-Evaluation

● Graduation Requirements

Students enrolled in Sophia University must meet the following two requirements to earn credits and graduate from the university: if you fail to meet either of the requirements, you will not be able to graduate and will need to repeat a year or a semester.

- 1 : To satisfy the residence requirement
(4 years; may vary for transfer, re-entry, and second-degree admission students)
- 2 : To take courses specified and obtain credits for graduation requirements
(Courses and credits required for graduation vary depending on your Department and the year in which you were admitted)

● Check Credits Required for Graduation

(1) Students are responsible for creating their course registration plans and meeting the above graduation requirements. (2) Students also must check that the plan satisfies all graduation requirements. It is the sole responsibility of the students to follow the above processes. The Center for Academic Affairs offers advisory services on course registration, but the office will not be responsible for checking graduation status and credit requirements or calculation for individual students. Students are responsible for checking whether or not they are able to graduate.

● How to Check Credits Required for Graduation

This function is made available to assist the students in checking the number of required credits for graduation by themselves; however, this is a mere calculation of credits on the computer system and is not a service to ensure graduation.

- 1) Check the Bulletin of Information
The courses and credits required for graduation vary depending on your Department and matriculation year.
Please thoroughly read the sections for your Department and matriculation year in the Bulletin of Information on “Courses and minimum number of credits required for graduation”, “Distribution of Required Credits”, and “Notes on Taking Courses ”; check for each course you have taken and the credits earned to which category of credits required for graduation they apply.
 - 2) Check the Loyola “Self evaluation” function
When you have checked the Bulletin of Information as shown in 1) above, please also check the Loyola “Self Evaluation” function as follows:
 - “Self Evaluation” function:
On Loyola you may check your status of courses taken and credits earned for each category of graduation requirements by calculating the missing number of credits you need for graduating from the sum total of credits of courses you are currently taking and the credits you have earned so far.
This function makes it simple and easy for you to check the number of credits required for graduating; however, it is a calculation of credits on the computer system and is not a service to ensure graduation.
 - “Self Evaluation” may not work for certain cases
Some Departments have complicated curriculum and the calculation/display may not work properly. For more details, please check the Loyola Bulletin Board (Academic Services) “Points to be noted on Self-Evaluation screen”.
 - Self Evaluation function available period
The Self Evaluation function on Loyola is available for a designated period only. For the schedule of available periods in the 2021 Academic Year, check the Loyola Bulletin Board (Academic Services).
- * Please note it is not available during course registration periods or withdrawal periods (4th year students may use the self evaluation function during course registration periods).

11. Credit Transfer and Approval

● Credit Transfer and Approval

Credits earned at other universities or colleges before entering Sophia University or credits earned at overseas universities during study abroad after entering Sophia may be transferred and approved as credits equivalent to those earned at Sophia.

The requirements and maximum limit of transfer credits will vary depending on the type of credit transfer. To have credits transferred, check the details before applying for credit transfer.

Requests for credit transfer will be processed among several offices and Departments before the final decision on the approval is made and this may take about a month after application. The decision on approval of credit transfer will affect your future course enrollment plan; apply well ahead to allow sufficient time for the approval procedure.

For procedures to transfer credits obtained during study abroad, read “Procedures for credit transfer and approval of study abroad credits”.

● Grades of Courses with Transferred Credits

The credits transferred and approved will be marked “N (認定 *Ninteī*)” on your transcript of records. Except for compulsory courses, basically the courses with transferred credits will not be listed under the course titles, but will be summed up by course category (elective compulsory, elective, group xx).

The grades marked “N(認定 *Ninteī*)” will not be counted into “Maximum credit limits” per semester or year at course registration; such grades will also not be included in the GPA calculation.

● Application Period for Credit Transfer and Approval

Depending on submission date of credit transfer application, the approved credits may be included in either “Spring Semester” or “Autumn Semester” and will be marked “N 認定 *Ninteī*”

January 24 (Mon), 2022 – July 22 (Fri), 2022: application submitted to Center for Academic Affairs
→ approved as credits for 2022 Spring Semester
July 25 (Mon), 2022 – January 23 (Mon), 2023: application submitted to the Center for Academic Affairs
→ approved as credits for 2022 Autumn Semester

● Transfer of Pre-matriculation Credits

Students who entered Sophia University as freshmen (or re-admitted students or second degree students) may apply for credit transfer for up to 30 credits earned at other universities, colleges, higher professional schools or Sophia School of Social Welfare prior to matriculation (must apply within 3 months after entering Sophia). However, credits previously approved as Sophia credits are excluded. For more information, inquire at the Center for Academic Affairs (Academic Services). Also read the “Bylaw on Transfer of Pre-matriculated Credits”.

● Credit Transfer of Transfer Students

Transfer students may apply for transfer of credits earned at other universities to be approved and counted as equivalent to credits required for graduation at Sophia.

■ Maximum limit of credit transfer

- 1) Credit transfer will be approved in categories of General Studies (*Zengaku-Kyotsu-Kamoku*) and Specialized Education respectively up to the number of credits required for graduation set by each Department.
- 2) The maximum number of credits that can be transferred will be decided by each Department up to one half of the credits required for graduation set by the Department.

Also read the “Bylaw on Credit Transfer of Transfer Students”.

● Credit Transfer for Teacher Certification Program

Transfer credits approved as credits earned at Sophia University may be approved as credits for the teacher certification program. If a student wishes to apply for credit transfer for the teacher certification program, inquire at the Center for Teaching and Curator Credentials.

● Graduate School Pre-admission Course Enrollment System

Undergraduate students who show excellence in their academic performance may enroll in courses designated by each Graduate School in their senior year following a screening. On admission to Sophia University Graduate School, the credits earned in such courses will be approved as pre-admission credits up to the maximum number set by the Graduate School.

Credits earned through the system of course enrollment prior to admission to Graduate School will not be approved as credits required for undergraduate graduation.

The Graduate Schools/Programs that have a system of course enrollment prior to admission to Graduate School are as follows:

- Graduate School of Theology
- Graduate School of Humanities, Master's Program in French Literature
- Graduate School of Human Sciences, Master's Program in Social Services
- Graduate School of Law, Juris Doctor Program
- Graduate School of Economics
- Graduate School of Global Environmental Studies
- Graduate School of Science and Technology

For more information, please read "Bylaw on Graduate School Pre-admission Course Enrollment of Undergraduate Degree Students"

● Credit Transfer by Student Exchange Agreement

If a current student earns credits at another university in Japan affiliated by a student exchange agreement, the credits will be transferred and approved as credits equivalent to those earned at Sophia.

There are two types of student exchange agreement: "in-country exchange type" and "credit transfer type".

Credits earned by Sophia students at the Japanese Universities with an exchange agreement will be approved as credits earned at Sophia, up to 30 credits for "In-country exchange type" and 10 credits for "Credit transfer type".

For more information on student exchange agreement, inquire at the Center for Academic Affairs (Academic Services)

Type	Exchange University	Maximum transfer credits	Form of exchange
In-country exchange	Seisen Jogakuin College Elizabeth University of Music Nagasaki Junshin Catholic University Fuji Women's University Kwansei Gakuin University	30 credits	Exchange students continue to be enrolled at Sophia University (student status at Sophia will be "study abroad"); during exchange period, students will take courses and engage in research at the host university.
Credit transfer	Tokyo Junshin's University Tokyo College of Music The University of Sacred Heart, Tokyo International Christian University	10 credits	Students will be enrolled at Sophia and take courses at Sophia and at the same time take courses and engage in research at the host university.

● Credit Transfer from Study Abroad

As a current student, if you earn credits on a student exchange program (study abroad at an overseas university under a student exchange agreement with Sophia) or on general study abroad (at a degree-awarding university approved by the Department Chair prior to studying), the credits will be transferred up to 30 credits and approved as credits equivalent to those earned at Sophia (must apply within 3 months after returning to Japan).

■ Calculation of credit transfer

(1) Most universities including US

One class hour (in minutes) \times number of classes in a week \times course duration (number of weeks) \div basic class hours at Sophia

(2) Universities in Spain, Brazil etc.

Total class hours in a year \times 60 (in minutes) \div basic class hours at Sophia

Basic class hours at Sophia

Type of courses	Basic class hours
Lectures/seminars	675 min (1 Credit)
Languages/seminars	1,350 min (1 Credit)
Experiments	2,025 min (1 Credit)
Physical exercise	1,350min (1 Credit)

* Note that for credit transfer, you must have the class schedule which is the basis for the calculation.

※ Approved credits “N” will not be counted into maximum credit limit per year. They will not be included in the GPA Calculation.

For more information, refer to the “Handbook for Study Abroad” issued by the Center for Global Education and Discovery.

12.Certification Program

Upon completion of the required coursework, you will be certified in the following areas.

- Teacher Certification (教職課程)
- Curator Certification (学芸員課程)

All of these programs are offered only in Japanese. Students interested in either of the programs are required to have a good command of Japanese both in speaking and writing and also attend special guidance sessions held by the Center for Teaching and Curator Credentials: the notices will be posted on Loyola for the Center for Teaching and Curator Credentials.

Please check out the bulletin board for necessary information.

13. Overseas Short-term Language Program/ Overseas Short-term Study Abroad Programs/ Social Engagement Program

● Credit from Overseas Short-term Language Programs

The programs are intended for students to participate in language programs at affiliated universities overseas during university vacations and to earn foreign language credits (2 credits).
Note:

- 1) While students in the last semester before expected graduation are eligible to participate in the program, no credit will be awarded.
- 2) Program taught in English will not be included in the graduation requirement

The grades for the language courses will be either “P (pass)” or “X (fail)”.

Courses with grades “P” or “X” will not be included in the maximum credit limit per semester or year at course registration or in calculation of GPA.

For more information on language programs, refer to “Foreign Language Courses” “Academic Handbook” (履修要覧) and “Handbook on Study Abroad” issued by the Center for Global Education and Discovery and also “Bylaws on Overseas Short-term Language Programs”.

● Credit from Overseas Short-term Study Abroad Programs

These programs are intended for students to participate in programs at affiliated universities abroad during university vacations to transfer credits successfully earned, and to have them approved as credits at Sophia. Note: while students in the last semester before expected graduation are eligible to participate in the program, credit transfer will not be possible.

Participating students should have a certain level of language proficiency to study their major subjects taught in a foreign language.

There are two types of Overseas Short-term Study Abroad programs, and credits will be marked differently.

- 1) Credits earned at a university offering the approved program are transferred and approved.
→ Grades will be shown as “N Nintei” (認定)
- 2) Courses registered as courses offered at Sophia;
→ Grades will be shown as “P (pass)” or “X (fail)”.

Courses with grades “P”, “X” or “N” will not be included in the maximum credit limit per semester or year or in the calculation of GPA.

For more information on overseas short-term programs, see “Handbook on Study Abroad” issued by the Center for Global Education and Discovery and also “Bylaws on Overseas Short-term Language Programs”

<List of Overseas Short-Term Study Abroad Programs>

※ The following programs may be changed or cancelled without notice; check the updated information at the Center for Global Education and Discovery.

(1) Credits transferrable to be approved as credits earned at Sophia

University	Language of instruction	Country	Program duration	Credits	Grades and credits
University of California, Los Angeles (UCLA)	English	USA	During summer vacation	Depends on courses taken by the participant	<ul style="list-style-type: none"> * May be approved as General Studies (<i>Zengaku Kyotsu Kamoku</i>) (Electives) or Specialized Education; will not be approved as language courses * Participant should consult the Department Chair before going abroad, and he/she will need to submit request for credit transfer upon return to Japan. * May be approved as credits for 2022 Autumn Semester; the grade given to successful participant will be “N” transfer approved (Nintei).
Ecole Supérieure des Sciences Commerciales d'Angers (ESSCA)	English	Hungary	During spring vacation	Depends on courses taken by the participant	<ul style="list-style-type: none"> * May be approved as General Studies (<i>Zengaku Kyotsu Kamoku</i>) (Electives) or Specialized Education; will not be approved as language courses * Participant should consult the Department Chair before going abroad, and he/she will need to submit request for credit transfer upon return to Japan. * May be approved as credits for 2023 Spring Semester; the grade given to successful participant will be “N” transfer approved (Nintei). * The program is based on an exchange agreement; the tuition is waived. (participants are responsible to pay their air fare, accommodation and meals).

(2) Courses taken may be considered equivalent to courses offered at Sophia

University	Language of instruction	Country	Program duration	Credits	Grades/credits	Faculty/Dept. offering course
University of California, Davis	English	USA	During summer vacation	2	<ul style="list-style-type: none"> * May be counted as elective Course of Science and Technology Shared Course Group I; will not be approved as credits required for graduation. * Credits will be given in 2022 Spring Semester and successful participants will receive grade “P”. 	Faculty of Science and Technology Common Programs
SOAS University of London	English	United Kingdom	During summer vacation	4	<ul style="list-style-type: none"> * May be counted as General Studies (<i>Zengaku Kyotsu Kamoku</i>) or Specialized Education course; will not be approved as language courses. * Credits will be given in 2022 Spring Semester and successful participants will receive grade “P”. 	Faculty of Foreign Studies
University of Oxford	English	United Kingdom	During summer vacation	2	<ul style="list-style-type: none"> * May be counted as General Studies (<i>Zengaku Kyotsu Kamoku</i>) (Electives) or Specialized Education course; will not be approved as language courses. * Credits will be given in 2022 Spring Semester and successful participants will receive grade “P”. 	Faculty of Foreign Studies
University of Victoria	English	Canada	During summer vacation	4	<ul style="list-style-type: none"> * May be counted as General Studies (<i>Zengaku Kyotsu Kamoku</i>) (Electives) or Specialized Education course; will not be approved as language courses. * Credits will be given in 2022 Spring Semester, and successful participants will receive grade “P”. 	Department of Management
University of North Carolina at Charlotte	English	USA	During spring vacation	2	<ul style="list-style-type: none"> * May be counted as elective Course of Science and Technology Common Programs Group I; will not be approved as credits required for graduation. * Credits will be given in 2022 Autumn Semester and successful participants will receive grade “P”. 	Faculty of Science and Technology Common Programs
Institut d'Etudes Politiques de Paris	English	France	During spring vacation	4	<ul style="list-style-type: none"> * May be counted as General Studies (<i>Zengaku Kyotsu Kamoku</i>) (Electives) or Specialized Education course; will not be approved as language courses. * Credits will be given in 2022 Autumn Semester and successful participants will receive grade “P”. 	Faculty of Foreign Studies

● Credit Transfer of Social Engagement Programs and Internship Courses

Sophia University has various social engagement programs overseas during the semester and university recess for which you can obtain and transfer credits.

【Social Engagement Programs】

Overseas programs, which include field works and service learning components, are available during university recess; the credits obtained for successfully completed courses may be transferred as Elective Courses of General Studies. However, if you intend to graduate at the end of the semester in which you will obtain such credits, you are eligible to participate in the program but no credits will be awarded. The grades given in the programs will be either “P (pass)” or “X (fail)”.

Courses with grades “P” or “X” are not counted into the “maximum credit limit” per semester or year at Course Registration. They are also not included in calculation of GPA.

Note that you need to plan your enrollment carefully as this course involves an overseas tour for which you will be responsible to pay and the course itself may be cancelled if the number of tour participants does not reach the minimum participant requirement.

【Internship Courses】

Credits will be given by successfully completing an internship course, organised under a partnership agreement between Sophia and a company, an international organization, or an agency. For the internship availability and its program details, (period, company list, etc.) please contact the Center for Global Education and Discovery (1F, Building No.2) for details.

Internship courses are graded as “P” (pass) or “X” (fail), and will not be counted into the “maximum credit limit” per semester or year. They are also not included into the GPA calculation.

Expenses incurred for participating in the program will be a responsibility of each student. In addition, a program may be cancelled, or the program content may be changed for unavoidable reasons.

Academic Records (Notifications/Certificates)

1. Academic Records

... P. 52

Student ID No. / Student ID Card / Residence Requirements /
Repeating a Semester / Study Abroad / Leave of Absence / Resuming Studies /
Suspension from University / Withdrawal and Dismissal /
Individual Information / For non-Japanese students (Residence status)

2. Certificates

... P. 57

Certificates from the Certificate Issuance Machine
Certificates issued at the Office

3. Change of Faculty/Department, Re-admission, Second degree admission

... P. 58

Change of Faculty/Department
Re-admission/Second Degree Admission

4. Early Graduation

... P. 59

Early Graduation

1. Academic Records

● Student ID Number

All students are given an individual Student ID Number upon entering the University. The Student ID Number is necessary in all parts of student life; memorize your Student ID Number.

(Example) A 22 11 001

Individual number given to student in the Department
 Department number (see List below)
 Matriculation year (*)
 Student status code (“A” means full-time undergraduate student)

* Transfer, Second degree admission, and Re-entry students are given ID numbers of the relevant matriculation year and this may be different from the actual year of entrance.

■ List of Department Numbers

Faculty	Department	Dept. No.
Theology	Theology	91
Humanities	Philosophy	11
	History	14
	Japanese Literature	15
	English Literature	16
	German Literature	17
	French Literature	18
	Journalism	19
	Human Sciences	Education
Psychology		82
Sociology		83
Social Welfare		84
Nursing		85
Law	Law	31
	International Legal Studies	32
	Legal Studies of the Global Environment	33
Economics	Economics	41
	Management	42

Faculty	Department	Dept. No.
Foreign Studies	English Studies	51
	German Studies	52
	French Studies	53
	Hispanic Studies	54
	Russian Studies	55
	Luso-Brazilian Studies	56
Global Studies	Global Studies	21
Liberal Arts	Liberal Arts (Spring Enrollment)	67
	Liberal Arts (Autumn Enrollment)	68
Science and Technology	Materials & Life Sciences	76
	Engineering & Applied Sciences	77
	Information & Communication Sciences	78

● Student ID Card

The Student ID Card certifies that you are a student of Sophia University. Carry it with you at all times as you may be asked to show it in various situations both on and off campus. Note carefully that in the following cases services may not be provided without your Student ID Card.

Student ID Cards should not be lent or given to another person regardless of the reason. Return the Student ID card to the university when you lose your student status by withdrawal from university etc.

■ You will need the Student ID Card in the following cases:

- 1) to take exams
- 2) to use the certificate issuance machine and obtain a certificate or student travel fare discount certificate
- 3) to enter the university main library, to borrow library books
- 4) to buy your commuting pass
- 5) to show at the request of officials when you are on trains etc. using a commuting pass or student discount ticket
- 6) to submit various application forms at the office
- 7) to show when requested by a faculty or staff of Sophia University

- **Valid Enrollment Sticker**

The student ID Card is valid only with a current Enrollment Sticker (在籍確認シール) affixed on the back. The sticker is valid for one academic year; students should obtain a valid current sticker at the beginning of each academic year. Students should also obtain a new and valid Enrollment Sticker if there are changes to the address or commuting routes, or when the commuting pass issuance records are filled.

- **Changes in the data of Student ID Card**

If there are any changes or errors in the data (name, date of birth etc.) on the Student ID Card, notify the Center for Academic Affairs, Academic Records Section.

- **When the magstripe invalid**

When you cannot enter the main library nor use the certificate issuance machine because of the magstripe error, please come to the Center for Academic Affairs.

<Attention>

Please keep free the card from the magnet like smartphone case or clasps of bags.

- **Lost, damaged or defective Student ID Card**

Request a re-issue at the Center for Academic Affairs, Academic Records Section; purchase a fee payment sticker (1,000yen, issued on the same day) and place it on the designated form, "Request for re-issue of Student ID Card" (学生証再発行願).

● Residence Requirements

The permitted period of enrollment at Sophia University is 8 years. Periods of leave of absence will not be counted toward the period of enrollment (Article 38, University Regulations). The required period to complete study courses (residence requirement) at Sophia University is 4 years except in cases of early graduation. Periods of leave of absence, suspension from the university, or study abroad exceeding one year are not counted toward the residence requirement (Article 13, Article 57-2, University Regulations).

● Repeating a Semester

A student who fails to complete the graduation requirements in the four years of study after entering the university will have to repeat a semester.

When a student needs to repeat a semester, a Student ID Card with an extended period of validity will be sent by postal mail to the student at the end of March or the middle of September.

● Study Abroad

Sophia university has two types of study abroad program, Exchange Program and General Study Abroad Program. To join these programs, students should submit "Request for Study Abroad (留学願)". Also students can study abroad taking leave of absence or joining the short term programs held during summer and spring vacation. Depending on the types and period of study abroad, there are differences in the tuition, application materials, inclusion in the residence requirement, and transfer of credits. Students who wish to study abroad should apply after thoroughly reading the "Handbook for Study Abroad" issued by the Center for Global Education and Discovery and plan their study well.

- **Eligibility**

Students who plan to apply for exchange program or general study abroad program should have finished at least 4 quarters and have obtained more than 32 credits at Sophia by the time they begin their study abroad program.

- **Period of Study Abroad**

Students can join Exchange program for one semester or one year without taking a leave of absence. Those participating in the General Study Abroad Program can study abroad from one quarter. It is possible to extend the study abroad term to 2 years in maximum, but up to one year will be included into the residence requirement.

- **Deadline for submission of the "Request for Study Abroad (留学願)"**

Center for Global Education and Discovery will provide the deadline for submission to the students participating in the exchange program.

Students who will go abroad on the general study abroad program should submit the “Request for Study Abroad (留学願)” 1 month prior to start study abroad AND the day before the Quarter start day.

■ **The University-designated Overseas Travel Insurance and Crisis Management Service**

Students traveling overseas as part of university-related programs, including general study abroad program and study abroad during the leave of absence are required to purchase the university-designated overseas travel insurance and crisis management service. For details, please inquire at the Center for Global Education and Discovery.

■ **Report of Return to Japan**

When students return from a study abroad, they should submit the “Report of Return to Japan (帰国届)” in 1 month. Students who joined the exchange program should submit the Exchange Report Form to the Center for Global Education and Discovery before submitting the Report of Return to Japan.

■ **Transfer of Credits**

Up to 30 credits earned on university pre-approved study abroad can be transferred to (credits earned during overseas study by taking leave of absence do not apply here). For more information, please see p.44, “11. Credit Transfer and Approval” and “Handbook of Study Abroad” issued by the Center for Global Education and Discovery.

● Leave of Absence

A student who wishes to take a leave of absence due to reasons beyond his/her control must consult the Department Chairperson or class teacher and submit the completed “Request for leave of absence” form (休学願). If the reason is illness, it must be accompanied by a doctor’s certificate.

In principle, students cannot cancel the request for leave of absence once it is submitted. Only when it is before the start of the quarter that the students wish to cancel the request, they may file for cancellation.

If students take a leave of absence and study abroad, they are required to purchase the university-designated overseas travel insurance and crisis management service. For details, inquire at the Center for Global Education and Discovery.

The period of leave of absence is not counted toward the residence requirement and graduation will be delayed for the duration of the absence. Also, a student who is taking a leave of absence cannot graduate in that quarter, even if all graduation requirements are met.

■ **Period of Leave of Absence**

Leave of Absence may be requested per quarter. A leave of absence may not extend over two consecutive years or a total of 4 years (Article 32 University Regulations).

Students who are taking a leave of absence cannot register courses. When the request for a leave of absence is granted after the course registration period, the courses held in that quarter or semester will be deleted automatically. For example, a student who takes a leave of absence in the 1st Quarter, can register courses held in 2nd, 3rd and 4th Quarters and Autumn semester, but cannot register courses held in 1st Quarter and Spring semester.

■ **Deadline to submit request**

Period of Leave of absence (Quarter)	Deadline to submit request
Spring Semester (1st+2nd Quarter)	April 30 (Sat)
April 1 – June 2 (1st Quarter)	April 30 (Sat)
June 3 – September 20 (2nd Quarter)	June 30 (Thu)
Autumn Semester (3rd+4th Quarter)	October 31 (Mon)
September 21 – November 18 (3rd Quarter)	October 31 (Mon)
November 19 – March 31 (4th Quarter)	December 20 (Tue)

A student who intends to take a planned leave of absence must submit the “Request for Leave of Absence” at least one month prior to the beginning of the academic year or semester of the planned absence.

Any requests submitted after the deadline will not be accepted for any reason. If the request is sent by postal mail, it must be postmarked on or before the deadline date. In the case of submission at the office, it must be submitted by 3:30 pm on the weekday prior to the deadline when the deadline is a school holiday. The request for leave of absence may be submitted for two consecutive years of absence.

- **Tuition and fees**

There will be a reduction of the tuition and fees during leave of absence. For more details, inquire at the Center for Academic Affairs (Tuition and Fees).

- **For Foreign Students with College Student Status of Residence**

Students with a “College Student” Status of residence who take a leave of absence may lose their status of residence in Japan. For details, please consult with the Academic Records Section.

● Resuming Studies

When the period for Leave of Absence is over, student status returns automatically to resume studies, so there is no need to submit an “Intent to resume studies” form (復学届). However, in the following cases, it is necessary to submit the “Intent to resume studies” form. (The deadline is the day before the beginning of the quarter that you intent to resume.)

- 1) leave of absence due to illness (attach supporting doctor's certificate 医師の診断書)
- 2) a student wishes to return to studies earlier than scheduled; permission for leave of absence was obtained for 2 or more quarters but the student wishes to shorten the period of absence as the reason for taking the leave no longer exists (the period may not be shortened to less than one quarter).

● Suspension from University

A student who commits violations such as misconduct in examination shall be given severe penalties including suspension or dismissal according to Article 60 of University Regulations. The period of suspension is not counted in the residence requirement and such student will not be able to graduate from university in four years, the normal residence requirement. Student will be able to return to university studies on the day following when the indefinite suspension is lifted or when the term of the definite suspension expires.

● Withdrawal and Dismissal

There are two types of withdrawal from the university: voluntary withdrawal and dismissal.

- **Date of Withdrawal**

The date of withdrawal shall be the end of the semester (September 20 or March 31).

- **Voluntary withdrawal**

A student wishing to withdraw from university for certain reasons must consult the Department Chairperson or class teacher, complete the “Request for Withdrawal from the University” (退学願) form and submit the request to the Center for Academic Affairs (Academic Records Section) with their Student ID Card, before the desired date of withdrawal.

Students who intend to withdraw from the university must have paid all tuition and fees for the period prior to the withdrawal.

- **Dismissal from the university**

The following students shall be dismissed from the university:

- 1) **Expiry of Period of Enrollment**

Students whose period of enrollment (excluding leave of absence periods) exceeds 8 years.

- 2) **Students to whom Article 40 of University Regulations applies**

Students who fail to obtain 32 credits or more including subjects specified by undergraduate departments in two consecutive academic years.

- 3) **Failure to pay tuition and fees**

Students who fail to pay the tuition and fees before the set deadline.

- 4) **Other reasons**

Students to whom Article 60 and 61 of the University Regulations apply.

● Individual Information

- **Change of address or phone number**

When there are changes in students' or the guarantors' address or phone number, students should update the information through “Address registration” menu on Loyola. In case the guarantor's address is outside Japan, they should submit the “Address change sheet (住所変更届)” to the Academic Records Section. This option is only for non-Japanese students. When

students change their own address, they need to obtain a new enrollment sticker (在籍確認シール) at the Academic Records Section.

■ **Change of student's name**

If there is a change in student's name, submit a "Name change sheet (氏名変更届)" available at the Academic Records Section, and attach a certificate of residence (住民票の写し) issued by the local government (stating the full name, date of birth; permanent address, family relation information and Individual Number (My Number) is not required).

■ **Guarantor**

Sophia university requires all students to have a guarantor. Sophia university sends important notices regarding academic affairs and school newsletters to the guarantor's address, or may contact the guarantor in the case of emergency. Please note some of the notices may not be sent to the guarantor living abroad.

A guarantor should be one of the below (listed in order of priority):

1. A parent who lives in Japan
2. A person who lives in Japan and earns his/her living independently
3. A person who earns his/her living independently and who lives in a foreign country (This option is only for non-Japanese students)

■ **Change of the guarantor**

If students intend to change the guarantor, they need to submit the "Guarantor change sheet (保証人変更届)" to the Academic Records Section.

■ **Change of nationality**

If there is a change in student's nationality, submit a certificate of residence (住民票の写し) issued by the local government, which includes the full name, date of birth for all students, nationality, status of stay, period of stay, resident card number for non-Japanese students.

● **For non-Japanese students (Residence status)**

All non-Japanese students must have appropriate residence status.

It means "College Student" or other residence status such as "permanent resident", "long term resident", or "dependent". A temporary visitor visa is not acceptable.

All non-Japanese students are required to notice their residence status and period of stay in Japan to Sophia university. When they renew the resident card, they should submit their resident card as soon as possible to the Academic Records Section. Failure of submission may cause various result like suspension of Loyola ID, termination of scholarship benefits, or other inconveniences.

■ **Residence status of "College Student"**

Residence permission is the permission for non-Japanese residing legally in Japan for the mid- to long-term who have resident status under the Immigration Control Act ("mid- to long-term residents"). For students who study at an university in Japan may obtain "College Student" status. Non-Japanese people should carry the resident card at all times.

If students take leave of absence or withdraw from the university, they should change the residence status or go out from Japan.

■ **Extension of period of stay under the "College Student" residence status**

When students holding "College Student" status intend to extend the period of stay, they should fill out the application for extension of period of stay "For applicant, part 1-3". The "For organization, part 1-2" must be filled out by the Academic Records Section. The issuing fee is 200 yen and it will take 3 working days.

They can apply for extension from 3 months prior to expiration date at the Immigration Bureau. Please be aware that staying in Japan beyond the period of stay is illegal and may be punished.

■ **Change of residence status to "College Student"**

When students intend to change their residence status to "College Student", they should fill out the application for change of status "For applicant, part 1-3". The "For organization, part 1-2" must be filled out by the Academic Records Section. The issuing fee is 200 yen and it will take 3 working days.

Register the changes in your status of residence at your residential municipal office within 14 days.

*For non-Japanese Students with College Status of Residence

Students who take a leave of absence may lose their status residence in Japan. For details, please refer to the information given in the folder "外国人留学生/International Students" on Loyola Download Center.

2. Certificates

Various certificates are issued either from the certificate issuance machine or at relevant offices. **Check the types of certificates** you need and apply as follows:

● Certificates from the Certificate Issuance Machine (NB 1, NB 3)

Certificates	Fees	Day of issue	Notes
Certificate of Attendance (Japanese / English)	¥200	On the same day	Issuance machines are installed on: · 4th floor, Bldg. No.2; · Mejiro Seibo Campus (1st floor, Bldg. No.1) Service Hours: Mon. - Fri. 9:00 to 17:00 * any changes due to school events will be announced
Official Transcript (Japanese / English)	¥200		
Certificate of prospective graduation (Japanese / English)	¥200		
Certificate of Graduation (Japanese / English)	¥300		
Student Discount Certificate	free		
Medical Checkup Certificate (university designated form in Japanese only)	¥300		
Temporary Student ID Card (issued only during Final Exam period)	¥500		

Please follow the voice instructions of the certificate issuance machine on how to operate the machine.

- A Student ID Card is required to have the certificates issued. The certificate issuance machine is available for current registered students only.
- For the password, inquire at the Center for Academic Affairs, Academic Records Section.
- The Certificate of Prospective Graduation certifies that the student is eligible to graduate if the student has met all graduation requirements, but it does not mean that Sophia University guarantees the student's graduation. It can be issued from the first day of class (Spring Semester: April 12 / Autumn Semester: September 27) of your 7th semester. The Certificate of Prospective Graduation will not be issued during a leave of absence.
- The Certificate of Graduation is issued from September 12 to 20, 2022 for Spring Semester and March 15 to 31, 2023 for Autumn Semester, to those whose graduation has officially been announced.
- The Medical Checkup Certificate will not be issued to a student who has not undergone the medical checkup provided by the Health Center.

● Certificates issued at the Office

Certificates	Fees	Day of issue
Certificates necessary for application of "Permission to change the status of residence" and "Permission to extend period of stay"	¥200	3 working days from the application date
Certificate of payment of tuition and fees	¥300	

Office in charge: Center for Academic Affairs (Academic Records Section); 1F, Bldg. No.2

- 1) Complete application forms available at the office.
- 2) Purchase the fee payment sticker from the vending machine and place it on the application form.
- 3) Submit application form with your Student ID Card to the office. Receipts will be issued to the applicant.
- 4) On the day of issue, show the Receipt at the office and receive the certificates.

3. Change of Faculty/Department, Re-admission, Second Degree Admission

● Change of Faculty/Department

Students who wish to change to another Department and who satisfy the following requirements may do so by submitting a request. After submitting the request, the student will take an exam given by the intended Department.

■ Eligibility

- 1) Student has completed or is expected to complete at least four semesters of study at the time of the requested change (period of leave of absence is not included)
- 2) Student has a 2.6 GPA or higher for credits obtained in Language Courses (only compulsory courses) and General Studies (Zengaku kyotsu). (Only General Studies for students who entered before 2014).
- 3) Student satisfies all requirements set by the Department he/she wishes to change to.
- 4) There is adequate reason for the change.

Note: *Transfer of Faculty/Department is limited to one time.

*Transfer students and Re-admitted students cannot apply.

*Regarding change of Faculty/Department to SPSF Departments, please see For all SPSF students (p.104).

● Re-admission

Re-admission is admission of a student who has withdrawn from Sophia University and wishes to enter the same Department he/she had previously enrolled.

■ Eligibility

Student must fall under one of the following:

- 1) Withdrawal under Article 39, University Regulations (Voluntary withdrawal; withdrew on or before March 31, 2022 for Autumn 2022 entry)
- 2) Withdrawal under Article 64, University Regulations (failure to pay tuition and fees; withdrew on or before March 31, 2022 for Autumn 2022 entry)
- 3) Withdrawal under Article 40, University Regulations (32-credit system; withdrew on or before September 20, 2021 for Autumn 2022 entry)
- 4) Withdrawal under Article 60, University Regulations (violation of Regulations; withdrew on or before September 20, 2021 for Autumn 2022 entry)
- 5) Withdrawal under Article 61, University Regulations (violation of Four articles of inappropriate enrollment; withdrew on or before September 20, 2021 for Autumn 2022 entry)

The following students cannot apply for re-entry:

- 1) Withdrawal under Article 38; period of enrollment exceeded the permitted number of years (8 years).
- 2) Students who withdrew again after re-admitted.

● Second Degree Admission

Second Degree Admission is admission of students who have graduated (or are expected to graduate) from Sophia University and who wish to enter another Department for their second Bachelor's degree.

For more information, inquire at the Center for Academic Affairs (Academic Records Section).

※ The application for Change of Faculty/Department, Re-entry, Second Degree Admission will be available from early May 2022 for Autumn 2022 entry / November for Spring 2023 entry. For more details inquire at the Center for Academic Affairs (Academic Records Section).

4. Early Graduation

● Early Graduation

The basic residence requirement of Sophia University is 4 years. However, students (1) who are enrolled at Sophia for 3 years or more, (2) have completed the required courses for graduation with good academic performance and (3) who wish to graduate early, may request for approval for early graduation. Faculty meeting of the students affiliated faculty will review and decide upon applications for early graduation, which will be forwarded to the President for approval. For more information, please refer to the pages for FST and SPSF curriculum.

Faculty of Science and Technology Curriculum

For all English Program Students	… P. 62
General Studies	… P. 67
Language	… P. 73
Bachelor’s Program in Green Science	… P. 75
Bachelor’s Program in Green Engineering	… P. 87
Course List	… P. 98

Objectives of Education and Research

To have students gain academic knowledge of a specialized field as their foundation and acquire “combined intelligence,” which is characterized by a wide range of knowledge that would enable them to view other fields objectively, through art-science integrated education, so that they can contribute to solving various problems in today’s highly diversified society.

Objectives of Human Resource Development

To foster human resources who can contribute to “scientific and technological development” by solving various problems in today’s highly diversified society with a broad vision acquired through knowledge of a specialized field and “combined intelligence”.

Diploma Policy

The Faculty of Science and Technology aims to foster human resources who have gained understanding of the Christian humanism spirit and have acquired the ability to solve, with a broad and international perspective, the various scientific and technological issues challenging today’s highly diversified society, and who can pursue original research based on high ingenuity and creativity and thus contribute to the further advancement of science and technology. With a view to this aim, each department sets standards for the skills and knowledge students should have acquired upon graduation as described herein. Those who have fulfilled the requirements and have passed the thesis defense will be awarded a diploma.

Curriculum Policy

In accordance with the diploma policy, the Faculty of Science and Technology constructs its curriculum as follows:

1. To acquire fundamental abilities to solve science and technology issues from a broad international perspective through coursework in lecture-based Faculty of Science and Technology Categories I and II General Courses which students should commonly take.
2. Based on the above, to acquire specialized abilities through Departmental Core Courses centered on seminars and laboratory classes and to acquire the ability to pursue research with originality through Specialized Courses characterized by higher expertise.

*The English translation of objectives and policies of the faculty and departments are provided for information, and the original Japanese version remains the sole official version. If there is any discrepancy between the two versions, the Japanese original should take precedence.

For all English Program Students

1. Organization of the Faculty of Science and Technology

The Faculty of Science and Technology aims to provide students with “cross-disciplinary understanding” that integrates “science” and “technology”. With its motto being “human and environmental support,” the Faculty seeks to produce graduates who are able to take active steps toward realizing human societies that thrive in harmony with nature. It aims to nurture in students the ability to adapt to today’s knowledge-based societies. To this end, the Faculty is made up of the following three departments:

1. Department of Materials and Life Sciences
2. Department of Engineering and Applied Sciences
3. Department of Information and Communication Sciences

Each department offers a variety of unique educational programs. The Department of Materials and Life Sciences aspires to impart to students “new and innovative ways to explore materials that are in harmony with nature”; the Department of Engineering and Applied Sciences endeavors to teach students “ways to create materials and devices that will greatly benefit both global and human environments”; and the Department of Information and Communication Sciences seeks to offer students “an in-depth understanding of humans and society through information”.

To meet the diverse needs of internationalization, the Faculty added two new programs taught entirely in English as part of its regular curriculum in September 2012. Students enrolled in those programs are required to complete all courses, take examinations, submit reports, undergo research guidance, and submit their undergraduate thesis in English.

In this Faculty, classes are divided into General Studies courses (Zengaku Kyotsu Kamoku) and Specialized Education courses (Gakka Kamoku). Students must take classes that satisfy all of the requirements for their particular programs. However, since the university is a place where students gain academic knowledge through studying, it is important for students to play an active role in planning the content of their own study programs and take full responsibility for their own learning.

2. General Studies (Zengaku Kyotsu Kamoku)

At Sophia University, University-wide General Studies are designed for students to acquire the abilities necessary for various studies. In addition to learning the spirit of “Christian Humanism” that underlies all Sophia University education, students will cultivate the ability to identify issues, formulate questions, and solve problems from multiple perspectives with a wide range of knowledge. The purpose is to create a foundation for students to continue learning throughout their lives and to contribute to the realization of a better world as people who live “for others, with others.”

University-wide General Studies courses are structured into categories by topics and in multiple levels. The students are expected to take these courses throughout their undergraduate studies in order to expand the depth and the width of their learning.

Refer to the General Studies section (p.67 – 72) for further details.

3. Language

For students studying science and technology at the university level, there is an increasing need to acquire the ability to read textbooks and other documents as well as to present the results of their research in various languages. Furthermore, once they graduate, various languages will play an even more important part in their lives, no matter what career path they choose to specialize in. This stems from the international nature of science and technology, and the trend will increase in the future. However, various languages are not only important for practical reasons, but will also help students to develop a rich body of knowledge and ways of thinking, which are essential qualities for scientists and technological experts.

This university serves as a bridge among countries, with teams of excellent instructors to provide students with foreign language guidance. We invite students to take full advantage of the opportunities provided by this

superlative learning environment. To avoid having regrets in the future, we encourage students to master various languages while they are at university and their memory is still sharp.

“Academic Skills 1 and 2” are compulsory courses. From Academic Year 2022, Critical Thinking and Discussion becomes a compulsory course as well. Please see p.67

In addition, for those wishing to take Japanese or any other language course, up to 8 credits from such courses can be included in their graduation requirements for an elective course in General Studies (Zengaku Kyotsu Kamoku).

4. Specialized Education (Gakka Kamoku)

There are four types of Specialized Education (Gakka Kamoku): 1) Faculty of Science and Technology Common Subject Group I and II (which are required for all students in the Faculty of Science and Technology), 2) Core Courses that form the main course groups of each department and 3) Specialized Courses offered by each department. Among these are compulsory courses, compulsory elective courses, elective courses, and optional courses. Optional courses are courses for which credits do not count towards graduation.

For the Faculty of Science and Technology General Subject Group I and II, students are not permitted to enroll in courses other than those included in the English program (i.e., courses in Japanese). However, for the Core Courses and Specialized Courses, students are permitted to enroll in courses other than those included in the English Program.

1) Faculty of Science and Technology General Subject Group I

The Faculty of Science and Technology Common Subject Group I includes introductory courses related to science and technology that aim to broaden students' knowledge of these fields.

This group includes “English for Science and Engineering”.

2) Faculty of Science and Technology General Subject Group II

This group contains courses that students are required to take in preparation for Core Courses and Specialized Courses.

Students can transfer surplus credits from compulsory elective courses to elective courses in the Faculty of Science and Technology Common Subject Group II.

3) Department Core Courses

Department Core Courses are the groups of courses that form the core curriculum for each department, including experiments, seminars, and graduation research.

Experiment-based and practical courses are merged with courses that are taught in Japanese by experienced teaching staff or international teaching assistants. Seminars and graduation research are supervised by faculty members who accept students.

4) Department Specialized Courses

Regarding elective courses among department courses, the number of credits that students are able to allocate from the elective courses of other departments in the Faculty of Science and Technology is up to half of the credits required for graduation.

5. Graduate School

The graduate school at this university offers master's degree programs and doctoral degree programs. Master's degree programs are two years in duration; upon completion students will earn a master's degree. Given that science and technology include many different fields, the graduate school provides students with a highly specialized education that is based on the knowledge acquired in their undergraduate studies. With advances in science and technology, there is an increasing demand for people to earn masters or doctoral degrees. In addition, reducing the length of study for postgraduate degrees is under consideration. Therefore, we invite students currently enrolled in undergraduate programs to consider continuing their studies at the postgraduate level.

Students who wish to enter the graduate program at Sophia University are able to take certain lectures in their fourth year under the system for graduate school pre-entrance course registration. The credits for the lectures will be admitted as effective credits within the defined limit upon entering the graduate program. Lectures that have been taken under the system for graduate school pre-entrance course registration will not be admitted as effective credits for the graduation of the undergraduate program. For further details of pre-graduate school credits, please

consult with your Class Advisor, or Head of Graduate School.

6. Qualifications

By taking the required courses and graduating from one of the departments in this faculty, students can obtain a number of qualifications which may serve as prerequisites for test(s) and/or obtaining licenses (in Japanese language). Please refer to the Academic Handbook (履修要覧) for more details on the main qualifications.

7. Faculty of Science and Technology Early Graduation System

【For students who entered from 2020】

The Faculty has an early graduation system in place for students who wish to enroll in a master's program offered by the university as their first priority and thereafter enroll in a doctoral program of the university. Early graduation refers to graduation for students who have spent three years or more at the university (excluding periods of leave of absence from the university) and fulfilled the prescribed procedures, and will graduate upon completion of their 3rd year (six semesters) or half of their 4th year (seven semesters).

1) Qualifications and Procedures for Requesting Early Graduation

1. Students who have met the following conditions upon completion of their 2nd year are eligible to apply for early graduation registration:
 - (1) Have obtained 24 credits or more that count toward graduation from General Studies (Zengaku Kyotsu Kamoku) and have obtained 4 credits or more that count toward graduation from Language, including all the compulsory courses in their 1st year;
 - (2) Have obtained 60 credits or more that count toward graduation from Specialized Education (Gakka Kamoku), including all compulsory courses in their 2nd year;
 - (3) Have a GPA for all the university-wide courses and Specialized Education (Gakka Kamoku) of 3.65 or higher (numeric value in transcript).
2. The application procedures for early graduation registration are as follows:
 - (1) Receive guidance from the department chair regarding the application for early graduation registration at the end of the 2nd year.
 - (2) In addition to registering in Graduation Research I, submit an Application for Early Graduation Registration, only if approval is obtained from the academic supervisor from whom students wish to receive guidance at the beginning of the 3rd year.
 - (3) Receive official approval for the Application for Early Graduation Registration from the above-mentioned academic supervisor for Graduation Research I.
3. Following application for early graduation registration as well as receiving guidance from their academic supervisor, students must submit periodic reports to their academic supervisor about their academic progress and receive appropriate guidance.

2) Evaluation for Early Graduation

Students who meet all of the following conditions are eligible to make a request for early graduation:

- (1) The student in question wishes to graduate early and has registered a request for early graduation;
- (2) At the time of early graduation, the student has obtained credits in all of the prescribed subjects required for graduation;
- (3) At the time of early graduation, the student has a GPA in both university-wide subjects and Specialized Education (Gakka Kamoku) of 3.65 or above in grade transcript.

3) Withdrawal of Registration of Request for Early Graduation, and Changes to the Graduation Period

Students who wish to change the period in which they want to graduate following registration of a request for early graduation or who want to withdraw the request itself are required to complete the following procedures:

- (1) For changes to the period of desired graduation, the student must receive official approval from their academic supervisor on Notice of Changes to Period of Request for Early Graduation and submit it to the Chairperson of the department by the submission deadline for procedures.
- (2) For withdrawals of requests for early graduation, the student must receive official approval from their academic supervisor on Notice of Withdrawal of Registration of Request for Early Graduation and submit it to the Chairperson of the department by the submission deadline for procedures.

[Procedure] * Please refer to the Loyola bulletin board for distribution of documents and other details.

Documents to be submitted	Submission period	
Application for early graduation registration	3rd year, from October 1 to October 31 (except university non-business days and holidays)	
Notification of change of early graduation date	Until the 3rd year spring semester registration period	
Withdrawal of application for early graduation registration	In the case of withdrawal of early graduation application after completing six semesters	Until 3rd year spring semester course withdrawal period or 2Q course withdrawal period
	In the case of withdrawal of early graduation application after completing seven semesters	Until 4th year autumn semester course withdrawal period or 4Q course withdrawal period

【For students who entered from 2016 to 2019】

The Faculty has an early graduation system in place for students who wish to enroll in a master's program offered by the university as their first priority and thereafter enroll in a doctoral program of the university. Early graduation refers to graduation for students who have spent three years or more at the university (excluding periods of leave of absence from the university) and fulfilled the prescribed procedures, and will graduate upon completion of their 3rd year (six semesters) or half of their 4th year (seven semesters).

1) Qualifications and Procedures for Requesting Early Graduation

1. Students who have met the following conditions upon completion of their 2nd year are eligible to apply for early graduation registration:
 - (1) Have obtained 24 credits or more that count toward graduation from General Studies (Zengaku Kyotsu Kamoku) and have obtained 4 credits or more that count toward graduation from Language, including all the compulsory courses in their 1st year;
 - (2) Have obtained 60 credits or more that count toward graduation from Specialized Education (Gakka Kamoku), including all compulsory courses in their 2nd year;
 - (3) Have a GPA for all the university-wide courses and Specialized Education (Gakka Kamoku) of 3.65 or higher (numeric value in transcript).
2. The application procedures for early graduation registration are as follows:
 - (1) Receive guidance from the department chair regarding the application for early graduation registration at the end of the 2nd year.
 - (2) In addition to registering in Graduation Research I, submit an Application for Early Graduation Registration, only if approval is obtained from the academic supervisor from whom students wish to receive guidance at the beginning of the 3rd year.
 - (3) Receive official approval for the Application for Early Graduation Registration from the above-mentioned academic supervisor for Graduation Research I.
3. Following application for early graduation registration as well as receiving guidance from their academic supervisor, students must submit periodic reports to their academic supervisor about their academic progress and receive appropriate guidance.

2) Evaluation for Early Graduation

Students who meet all of the following conditions are eligible to make a request for early graduation:

- (1) The student in question wishes to graduate early and has registered a request for early graduation;
- (2) At the time of early graduation, the student has obtained credits in all of the prescribed subjects required for graduation;
- (3) At the time of early graduation, the student has a GPA in both university-wide subjects and Specialized Education (Gakka Kamoku) of 3.65 or above in grade transcript.

3) Withdrawal of Registration of Request for Early Graduation, and Changes to the Graduation Period

Students who wish to change the period in which they want to graduate following registration of a request for early graduation or who want to withdraw the request itself are required to complete the following procedures:

- (1) For changes to the period of desired graduation, the student must receive official approval from their academic supervisor on Notice of Changes to Period of Request for Early Graduation and submit it to the Chairperson of the department by the submission deadline for procedures.
- (2) For withdrawals of requests for early graduation, the student must receive official approval from their

academic supervisor on Notice of Withdrawal of Registration of Request for Early Graduation and submit it to the Chairperson of the department by the submission deadline for procedures.

[Procedure] * Please refer to the Loyola bulletin board for distribution of documents and other details.

Documents to be submitted	Submission period	
Application for early graduation registration	3rd year, from October 1 to October 31 (except university non-business days and holidays)	
Notification of change of early graduation date	Until the 3rd year spring semester registration period	
Withdrawal of application for early graduation registration	In the case of withdrawal of early graduation application after completing six semesters	Until 3rd year spring semester course withdrawal period or 2Q course withdrawal period
	In the case of withdrawal of early graduation application after completing seven semesters	Until 4th year autumn semester course withdrawal period or 4Q course withdrawal period

General Studies

【For students who entered in 2022】

■ Compulsory Courses

All the compulsory courses are divided into designated timetables (blocks) for each department. The class and the registration code will be posted on the Loyola Bulletin Board. Check the Board and register by yourself during the registration period. The following courses are the compulsory General Studies courses.

Studies in Christian Humanism: For Others, With Others Liberal Arts of the Body

Both “Studies in Christian Humanism: For Others, With Others” and “Liberal Arts of the Body” are Quarter courses, and students must take them in designated blocks. Students must check their designated blocks on Loyola Bulletin Board.

Semester Offered	Day & Time
Autumn	Wed, 3

*Liberal Arts of the Body Special Class

This class is offered on Tuesdays second period in third quarter for students who have difficulty taking the designated “Liberal Arts of the Body” class due to health or other reasons.

Students who wish to take this course should contact the Center for Liberal Education and Learning (Embodied Wisdom Area) before the class begins.

Critical Thinking & Discussion

“Critical Thinking & Discussion” is a semester course. Students must take the course in the designated block.

Semester Offered	Day & Time
Spring	Tue, 1 Fri, 1

Overview of Data Science

“Overview of Data Science” is a semester course. Students must take the course in the designated block.

Semester Offered	Day & Time
Spring	Tue, 5

Thinking about Issues, Perspectives, and Positionality

“Thinking about Issues, Perspectives, and Positionality” is a semester course. Students must take the course in the designated block.

Also this is an *asynchronous course. The course materials will be uploaded on Moodle every Saturday. Students must enroll themselves in “Issues, Perspectives, and Positionality” on Moodle.

*Asynchronous classes: Classes are delivered in video lectures, slides, or other asynchronous formats.

Semester Offered	Day & Time
Autumn	Sat, 6

***Students who fail to complete the Compulsory Course in the first year.**

Must take them in the second year or later. The procedure of taking compulsory courses will be announced in the next year's Bulletin of Information.

■ Compulsory Elective Courses

Studies in Christian Humanism

These Compulsory Elective Courses must be taken in the third semester.

Course List

Registration CD	Semester offered	Course title	Cr.	Day & Time
GSCH0130	Autumn	STUDIES IN CHRISTIAN HUMANISM: PHILOSOPHY OF RELIGIOUS LANGUAGE	2	Tue, 5
GSCH0051	Autumn	STUDIES IN CHRISTIAN HUMANISM: THE LIGHT OF CHRISTIAN INTRODUCTION TO CATHOLICISM	2	Tue, 5

Please note that places in these courses will be chosen by lottery. Students should register for these courses during the **lottery registration period**. For details, See p.28~.

Advanced General Education Courses

Students must take 4 credits from the Advanced General Education courses listed in the University-wide General Studies courses in your junior / senior years. (cf.履修要覧)

Notes on Advanced General Education Courses for FST Students

All Students must take at least 4 credits of “Advanced General Education Course” as a part of GS Compulsory Electives.

- Students may take the Advanced General Education Course from the fifth semester (ie. their first semester in the junior year).
- If students take more than 4 credits of Advanced General Education Courses, he/she can count these credits as GS Electives courses.
- Most of the Advanced General Education Courses are lottery courses. Students must enter during the Lottery entry period.
- For lottery courses of “Advanced General Education Course”, students will not get accepted into more than one course per semester.

【For students who entered before 2022】

■ Health and Physical Education

For students who have not earned credits for “Wellness, the Body and Culture” must take “Wellness, the Body and Culture” (*Asynchronous course). Please note that places in these courses will be chosen by lottery. Students should register for these courses during the **lottery registration period**. For details, See p.28～.

*Asynchronous classes: Classes that deliver video, Power Point, and other teaching material files.

Students who entered before 2022 may take any of the following semesters.

Semester Offered	Day & Time
Autumn	Sat, 6
Spring	Sat, 6

■ Studies in Christian Humanism

Two courses in the category “Studies in Christian Humanism” (キリスト教人間学) for a total of 4 credits are compulsory for all students who are enrolled in the FST. Normally, students must take one course in their first semester and another in the second semester.

Course List

Registration CD	Semester offered	Course title	Cr.	Day & Time
GSCH0130	Autumn	STUDIES IN CHRISTIAN HUMANISM: PHILOSOPHY OF RELIGIOUS LANGUAGE	2	Tue, 5
GSCH0051	Autumn	STUDIES IN CHRISTIAN HUMANISM: THE LIGHT OF CHRIST:AN INTRODUCTION TO CATHOLICISM	2	Tue, 5

Please note that places in these courses will be chosen by lottery. Students should register for these courses during the **lottery registration period**.

■ Advanced General Education Courses

Students must take 2 credits from the Advanced General Education courses listed in the University-wide General Studies courses in your junior / senior years. (cf.履修要覧)

Notes on Advanced General Education Courses for FST Students

All Students must take at least 2 credits of “Advanced General Education Course” as a part of GS Electives.

- Students may take the Advanced General Education Course from the fifth semester (ie. their first semester in the junior year).
- If students take more than 2 credits of Advanced General Education Courses, he/she can count these credits as GS Electives courses.
- Most of the Advanced General Education Courses are lottery courses. Students must enter during the lottery entry period.
- For lottery courses of “Advanced General Education Course”, students will not get accepted into more than one course per semester.

【All Students】**■ Elective Courses**

Freshmen may take up to 4 credits of General Studies Elective Courses each semester.

Students may take courses from programs offered by Faculty of Liberal Arts. They must choose the courses either from 100~200 level courses offered by FLA or the Japanese Language Program. Note that only up to 8 credits are approved for courses from Language Programs. Students may also take any courses listed in the University-wide General Studies course as Zengaku kyotsu kamoku (全学共通科目). (cf.履修要覧)

■ List of Courses (General Studies Elective Courses offered by FLA)

AHST2510	Development of Japanese Civilization 1
AHST2520	Development of Japanese Civilization 2
AHST2610	History of Chinese Civilization
ASOC2010	Introduction to Sociology
ASOC2250	Introduction to Japanese Society
ASOC2260	The Good Life: from Self to Society
AANT2020	Introduction to Cultural and Social Anthropology
AANT2200	Anthropology of Japan
AANT2030	Nature and Culture
AART2010	Introduction to Art History/Visual Culture 1
AART2500	Introduction to Art History/Visual Culture 2
ALIT2010	Literary Genres
ALIT2030	Representations of Japan in Popular Culture and Literature
ALIT2310	Introduction to Japanese Literature
ARPH2010	Introduction to Philosophy
ARPH2020	Fundamentals of Religion
AIBE2001/2002	Principles of Microeconomics
AIBE2011/2012	Principles of Macroeconomics
APOL2010	Theories and Themes of Contemporary Politics
APOL2050	Introduction to International Relations
APOL2100	Introduction to Comparative Politics
APOL2150	Controversies in Globalization
ACOM221A/B/C	Computer Studies 1*
ACOM222A/B	Computer Studies 2*
ACOM223A	Computer Studies 3*
AENV1310	Environmental Issues 1
AGEO2010	Human Geography
AGEO2020	Geography
AMTH1010	College Mathematics
AMTH1111/2	Mathematics and Statistics for Business and Economics

*N.B. The courses with asterisk carry 2 credits each. Other courses listed are 4 credits each.

■ SAIMS Program Courses

☆ The Sophia AIMS Program (SAIMS) is a trans-disciplinary program focusing on “Human Development”, and its main theme is “Human Ecology: Diversity and Connectivity of Society and Nature”. Students from ASEAN countries and Japan will study together in a program that combines the disciplinary frameworks of natural sciences, social sciences, and humanities. All courses are conducted in English (TOEFL iBT79 or its equivalent level is required; the submission of a language score is required for the “Human Ecology: Rivers”).

The SAIMS program participants are strongly recommended to take at least one of these courses before or after studying abroad under the SAIMS program.

Registration CD	Semester offered	Course title	Cr.	Day	Time	Remarks
AANT3020	SPR	HUMAN ECOLOGY: RIVERS 1	2	Mon	1	※1
APOL3040	SPR	HUMAN ECOLOGY: RIVERS 2	2	Mon	2	※1
GSS20520	1Q	SUSTAINABLE DEVELOPMENT	2	Tue, Fri	3	※2, [100]
GSS20510	1Q	ENVIRONMENTAL SCIENCE	2	Mon, Thu	3	※2, [100]
GSS20500	2Q	CONSERVATION	2	Tue, Fri	3	[100]
GSS20521	3Q	SUSTAINABLE DEVELOPMENT	2	Tue, Fri	3	※2, [100]
GSS20511	3Q	ENVIRONMENTAL SCIENCE	2	Mon, Thu	3	※2, [100]
GSS20501	4Q	CONSERVATION	2	Tue, Fri	3	[100]

[]=Lottery Courses. Number in brackets is the capacity.

※1: AANT3020 and APOL3040 must be taken together in the same semester and require students to submit an application. For more details, please check the syllabus on Loyola and contact the FLA office (Build. 10, 4F).

※2: Green Science and Green Engineering students (FST English Course Students) can include these courses into their Departmental Specialized Education.

■ Japanese Language Program

The Center for Language Education and Research offers various levels of Japanese language courses. Students who need to use Japanese in daily life or wish to employ Japanese language proficiency in the workplace after graduation are encouraged to take Japanese language courses. For details, please refer to the booklet “JAPANESE LANGUAGE PROGRAM”.

■ Other Languages

Students who wish to take language courses, please inquire at the Center for Academic Affairs for details.

Language (ACADEMIC SKILLS / ACADEMIC WRITING)

■ Course Details

ACADEMIC WRITING 1 (AW1)

In this course, students will develop their academic writing skills using a four skills integrated approach to well-equip them to write essays and research papers for undergraduate classes in English. The course will take a task-based, learn through doing approach to writing, starting from finding and evaluating academic sources and developing research questions, through to editing and discussing written work in seminar style classes. Students will write about topics related to modern society in Japan which interest them. Classes will consist of input on academic writing skills from the teacher, in class writing exercises and practice, teacher and peer feedback on students' written work, and presentation and discussion of students' assignments.

ACADEMIC WRITING 2 (AW2)

This course will build on and further develop the academic writing skills learned in Academic Writing 1. Students will undertake a research project involving some original research which culminates in a research paper. This project will also require students to draw from more academic sources and have a focus on critique as well as summary or description. They will also have greater freedom to choose topic related to their own studies or interests.

CRITICAL THINKING & DISCUSSION

In this course, students will develop the critical thinking skills they need to perform well academically as undergraduates and beyond. They will learn key terms and concepts in critical thinking and practice applying those by closely examining a variety of texts on which they will write short summaries or reactions. Through this process, students will also reflect on their own thinking processes and skills. Most in-class work will be based around discussions of the various texts and topics, with input and guidance from the teacher on academic discussion skills. Students will also learn how to demonstrate their critical thinking skills in these discussions.

■ Registration Rules

【For students who entered from 2020】

- ACADEMIC WRITING must be taken in the following sequence:

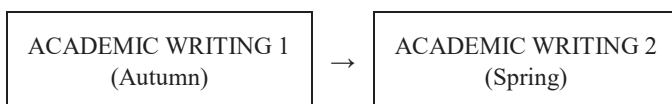

- * Students cannot register for the next course if they have not completed the previous course.
(If students have not passed AW1, they cannot register for AW2. If they are not able to fulfill the course requirements, they have to re-register for AW1 in the following Autumn semester.)
- * Students cannot register for the same course which they have already passed.
- Students must take all courses and complete 4 credits. (2 credits / course)
- ACADEMIC WRITING is counted as a Compulsory Language Course.
- No withdrawals are allowed for these courses.
- Students should register for these courses during the registration period. Students are required to take designated classes.

【For Students who entered from 2014 to 2019】

- ACADEMIC SKILLS 1/2 is replaced by ACADEMIC WRITING 1/2. Those students who have not completed ACADEMIC SKILLS 1&2 must take ACADEMIC WRITING 1&2.
- Those students who have only completed ACADEMIC WRITING 1 must take ACADEMIC WRITING 1 offered in Autumn semester, instead of ACADEMIC SKILLS 2.

- Students must complete 4 credits with ACADEMIC SKILLS / ACADEMIC WRITING.
- ACADEMIC SKILLS / ACADEMIC WRITING is counted as a Compulsory Language Course.
- No withdrawals are allowed for these courses.
- Students should register for these courses during the registration period. Students are required to take designated classes.

■ Attendance policy

NOTE: Attendance rules may be changed if the class format changes due to the spread of the new coronavirus infection.

After registering for courses be sure to check the guidance from the Language Education and Research Center on the Loyola University Bulletin Board (Language Course • LCC) before the start of the class.

In language courses offered by Center for Language Education and Research (CLER), students are required to attend the following number of classes as listed below. Class attendance is essential for students' learning and is considered a minimum condition for gaining credits for the course. A final grade will be considered based on the evaluation criteria stated in the syllabus of each course, only if the number of required attendance has been met.

Meeting the attendance requirement does not guarantee passing course units. The number of required attendance is a minimum condition and any absences and/or tardies will affect the student's grade.

Attendance will be counted from the first class meeting. When a student attends a class in the first week but decides to withdraw from the course and registers to a course with a different registration code, the attendance from the previous course(s) will not be transferred to the newly registered course.

CLER does not allow absences except for the below. Therefore, job hunting, any events related to seminar or extracurricular activities, transportation delays and bereavement leaves are not included. Students should attend classes regularly in case of any sudden illnesses or any reasons other than the "Special Consideration" cases.

*For Attendance Policy of Japanese Language Courses, please refer to the "Japanese Language Program" brochure.

• Twice-a-week courses (Except for Japanese Language Program)

The total number of class sessions: **28 per semester**

The number of attendance required: At least 23 per semester

- Special Consideration

In any of the following conditions, neither your attendance nor absence will be counted. If applicable, please ask your instructor if you can receive this special treatment.

For up to three weeks, the special treatment will apply. As for the period of absence that goes beyond three weeks, regardless of the reasons you may have, the special treatment will not apply. In addition, if the absence is due to more than two circumstances stated below and exceeds three weeks, special consideration will not cover those additional days. Please ask your instructor about the required number of attendance when the special consideration is granted. If your instructor gives you an assignment to make up for your absence, the submission of the assignment becomes the prerequisite for receiving the special consideration.

1. A case of illness or injury where you submit a medical certificate indicating the necessary period of sick or injury leave. (*1)
2. When you join the annual Jo-Nan competition and submit an official certificate of participation.
3. When you have been officially assigned to lay judge (裁判員/Saiban In/) and must assume the duty.
4. When you submit a certificate that confirms your attendance at teaching practice, volunteer experience study (介護等体験 /Kaigotou Taiken/), or museum practice.

(*1) If you have chronic medical conditions and cannot specify periods of sickness or injury leave, you should consult the CLER Office (Floor 5, Bldg. 6) in advance. The deadline for informing the office is; Friday, April 29 (Spring Semester) / Friday, October 14 (Autumn Semester)

- Late Arrival

Any student who fails to arrive within the first 30 minutes of a class will be regarded as being absent, even if he/she attends the rest of the class.

Department of Materials and Life Sciences

Bachelor's Program in Green Science

Education and Research Objectives

To have students learn academic subjects, such as physics, chemistry, biology, environmental science, and materials science, in an interdisciplinary manner, understand the fundamentals of atoms, molecules, macromolecules, and materials related to natural phenomena, and improve their ability to apply and practice what they have learned.

Human Resource Development Objectives

To develop human resources who have new perspectives of materials and life sciences and can work toward the sustainable integration of the global environment with science and technology, so that they can contribute to creating materials and technologies on the basis of new concepts.

Diploma Policy

The Department of Materials and Life Sciences aims to foster human resources with integrated knowledge based on a broad perspective and a sense of life and materials harmonized with nature. With a view to this aim, the Department sets standards for the skills and knowledge students should acquire before graduation as described below. Those who have fulfilled the requirements and have passed the thesis defense will be awarded a diploma.

1. Understanding of the fundamentals of natural science disciplines and safety and ethical/moral values regarding science and technology
2. The ability to understand physical, chemical and natural/living phenomena based on the fundamentals of physics, chemistry and biology.
3. The ability to systematically understand the fundamentals of materials and life and contribute to the creation of substances ranging from atoms and molecules to polymers and biological materials as well as technology development.
4. The ability to contribute to solving science and engineering issues leading to substances and nanotechnology, harmonization of environment and life, and the creation of high-performance material by acquiring the ability to apply and develop what one has learned theoretically and technologically.

Curriculum Policy

In accordance with the Diploma Policy, the Department of Materials and Life Sciences constructs its curriculum as follows:

1. To understand the fundamentals of natural science disciplines and acquire safety and ethical/moral values regarding science and technology through coursework in Science and Technology Category I General Courses.
2. To acquire the fundamentals of the natural sciences in general, including physics, chemistry, biology, informatics, and mathematics through coursework in Faculty of Science and Technology Category II General Courses and simultaneously acquire skills in English comprehension and expression by becoming familiar with science and technology-related English communication
3. To acquire the ability to contribute to the creation of substances ranging from atoms and molecules to polymers and living molecules through coursework in Departmental Core Courses on materials and life (lectures and laboratory classes in physics, chemistry and biology).
4. To study highly academic contents on substances and nanotechnology, harmonization between environment and life, and the creation of high-function materials (Departmental Specialized Subjects) and thus acquire problem-solving approaches to applied and emerging disciplines, interdisciplinary fields and human society.
5. To acquire the qualities of a researcher through small-group education where cutting-edge disciplines are understood through graduate research and seminars, and findings are presented, thus acquiring the ability to apply and develop what has been learned theoretically and technologically.

1. Courses and Minimum Number of Credits Required for Graduation

Total: 124 credits are required for graduation.

【For students who entered from 2022】

General Studies (Zengaku Kyotsu Kamoku)

Compulsory: 8 credits (Studies in Christian Humanism: For Others, With Others: 1 credit. Liberal Arts of The Body: 1 credit. Critical Thinking & Writing: 2 credits. Overview of Data Science: 2 credits. Thinking About Issues, Perspectives and Positionality: 2 credits.)

Compulsory electives: 6 credits (Studies in Christian Humanism: 2 credits. Advanced General Education Courses: 4 credits)

Electives: 12 credits

Language

Compulsory: 4 credits (English)

Specialized Education (Gakka Kamoku)

Compulsory: 29 credits

Compulsory electives: 13 credits

Electives: 52 credits

【For students who entered from 2018 to 2021】

General Studies (Zengaku Kyotsu Kamoku)

Compulsory: 2 credits (Health and Physical Education: 2 credits)

Compulsory electives: 4 credits (Studies in Christian Humanism)

Electives: 20 credits (including Advanced General Education Courses: 2 credits)

Language

Compulsory: 4 credits (English)

Specialized Education (Gakka Kamoku)

Compulsory: 29 credits

Compulsory electives: 13 credits

Electives: 52 credits

【For students who entered from 2015 to 2017】

General Studies (Zengaku Kyotsu Kamoku)

Compulsory: 2 credits (Health and Physical Education: 2 credits)

Compulsory electives: 4 credits (Studies in Christian Humanism)

Electives: 20 credits (including Advanced General Education Courses: 2 credits)

Language

Compulsory: 4 credits (English)

Specialized Education (Gakka Kamoku)

Compulsory: 31 credits

Compulsory electives: 11 credits

Electives: 52 credits

2. Distribution of Required Credits

Please see p.82 ~ 86

3. Precautions when Choosing Courses

1) Specialized Education (Gakka Kamoku)

【For students who entered from 2020】

(1) Classification of Specialized Education (Gakka Kamoku)

Faculty of Science and Technology General Subject Group I:

These are fundamental courses taken by all students of the Faculty of Science and Technology. Courses in this group consist of compulsory courses (16 credits) and compulsory elective courses (English for Science and Engineering (2 credits)).

Faculty of Science and Technology General Subject Group II:

This group is a continuation from Group I, which consists of common courses that form the foundation for studying specialized courses. While these courses are taken by all students of the Faculty of Science and Technology, some courses are particularly relevant for each department. Therefore, a number of courses are designated as compulsory elective courses by the department. To graduate, students need 28 credits from this particular group, including 8 credits from the compulsory elective courses.

Department Core Courses:

Courses in this group form the educational core of each department and include experiments, exercises, seminars, Research Trial Autumn and Spring, and graduation research. Some of the experiment-based and practical courses are compulsory elective courses while others are compulsory courses. A combined total of 16 credits from this group must be completed. Starting in 2021, Research Trial Autumn and Spring have been established for 3rd year students. The purpose of these courses is to provide the students an early-stage experience of actual research activities, within the department, to earn a deep understanding on how to approach research activities and specialized subjects of the department.

Department Specialized Courses:

These specialized courses offered by each department are electives. Students are required to take 32 credits from these courses in order to graduate.

(2) Credits Required for Graduation

To graduate, students are required to take a total of 94 credits from Specialized Education Courses (Gakka Kamoku): 29 credits from compulsory courses, 13 credits from compulsory elective courses, and 52 credits from elective courses.

(3) English for Science and Engineering

Students are required to take the compulsory elective course “ENGL. FOR SCI/ENGINEERING” from the Faculty of Science and Technology Common Subject Group I.

(4) Faculty of Science and Technology Common Subject Group II

Students must complete 8 credits or more from the compulsory elective courses in this group specified by their department. For students taking more than 8 credits, they can count the extra credits toward the Faculty of Science and Technology Common Subject Group II elective courses. Combined with extra credits from compulsory elective courses, students must take 20 credits from the elective courses in this group.

(5) Experiment-based and Practical Subjects from Department Core Courses

Students must take 13 credits from the compulsory courses in the Department Core Courses group. In addition, they must take 3 or more credits combined with compulsory elective courses from the Department Core Courses group other than English Courses.

MATERIALS AND LIFE SCIENCES LAB. A, LAB. B and LAB. C are compulsory subjects.

Students must register to one of the compulsive elective subjects CHEMISTRY LAB. 1 or BIOLOGY LAB. 1.

Students must register to one of the compulsive elective subjects CHEMISTRY LAB. 2 or BIOLOGY LAB. 2.

Students must register to one of the compulsive elective subjects PHYSICAL CHEMISTRY LAB. or BIOLOGY LAB. 3.

There is an upper limit to the student number for each of the above mentioned compulsory elective courses. In case that the upper limit is reached, students with higher GPA×credits are given priority in the placement of the students.

The following quarter courses must be registered during the Autumn and Spring registration periods (as if they are semester courses).

• Autumn: [MATERIALS AND LIFE SCIENCE LAB. C] and [CHEMISTRY LAB. 1 or BIOLOGY LAB. 1]

• Spring: [CHEMISTRY LAB. 2 or BIOLOGY LAB. 2] and [PHYSICAL CHEMISTRY LAB. or

BIOLOGY LAB. 3]

Corrections or additions to the above experimental courses during the quarter courses extra course registration period is not allowed.

- (6) Department Specialized Courses
Students must take 32 credits or more from elective courses.
- (7) Optional Courses within the Department Specialized Courses
Starting in 2021, the courses Research Trial Autumn and Spring will be available for all students, these courses are offered by the Materials and Life Science Japanese Language Program but imparted in English. The credits obtained from these courses will not count for the required graduation credits.
- For a student to be able to register for Research Trial Autumn and Spring, the student must have previously passed; EXPERIMENTS & EXERCISE OF BASIC SCIENCE, MATERIALS AND LIFE SCIENCE LAB. A, and B. Additionally, the students are required to possess training on safety procedures equivalent to MATERIALS AND LIFE SCIENCE LAB. C.
 - There is an upper limit to the number of students that the teaching staff can accept each semester. In case that the registered students pass the upper limit, students will be accepted based on the student's grade.
 - Since these are optional courses their credits do not count as graduation credits, however the department strongly encourages the students to take this opportunity as a first-hand experience on research work.
 - For details, follow the instructions given by the department.

【For students who entered in 2018 and 2019】

- (1) Classification of Specialized Education (Gakka Kamoku)

Faculty of Science and Technology General Subject Group I:

These are fundamental courses taken by all students of the Faculty of Science and Technology. Courses in this group consist of compulsory courses (16 credits) and compulsory elective courses (English for Science and Engineering (2 credits)).

Faculty of Science and Technology General Subject Group II:

This group is a continuation from Group I, which consists of common courses that form the foundation for studying specialized courses. While these courses are taken by all students of the Faculty of Science and Technology, some courses are particularly relevant for each department. Therefore, a number of courses are designated as compulsory elective courses by the department. To graduate, students need 28 credits from this particular group, including 8 credits from the compulsory elective courses.

Department Core Courses:

Courses in this group form the educational core of each department and include experiments, exercises, seminars, Research Trial Autumn and Spring, and graduation research. Some of the experiment-based and practical courses are compulsory elective courses while others are compulsory courses. A combined total of 16 credits from this group must be completed. Starting in 2021, Research Trial Autumn and Spring have been established for 3rd year students. The purpose of these courses is to provide the students an early-stage experience of actual research activities within the department, to earn a deep understanding on how to approach research activities, and specialized subjects of the department.

Department Specialized Courses:

These specialized courses offered by each department are electives. Students are required to take 32 credits from these courses in order to graduate.

- (2) Credits Required for Graduation

To graduate, students are required to take a total of 94 credits from Specialized Education Courses (Gakka Kamoku): 29 credits from compulsory courses, 13 credits from compulsory elective courses, and 52 credits from elective courses.

- (3) English for Science and Engineering
Students are required to take the compulsory elective course “ENGL. FOR SCI/ENGINEERING” from the Faculty of Science and Technology Common Subject Group I.
- (4) Faculty of Science and Technology Common Subject Group II
Students must complete 8 credits or more from the compulsory elective courses in this group specified by their department. For students taking more than 8 credits, they can count the extra credits toward the Faculty of Science and Technology Common Subject Group II elective courses. Combined with extra credits from compulsory elective courses, students must take 20 credits from the elective courses in this group.
- (5) Experiment-based and Practical Subjects from Department Core Courses
Students must take 13 credits from the compulsory courses in the Department Core Courses group. In addition, they must take 3 or more credits combined with compulsory elective courses from the Department Core Courses group other than English Courses.
- (6) Department Specialized Course
Students must take 32 credits or more from elective courses.
- (7) Optional Courses within the Department Specialized Courses
Starting in 2021, the courses Research Trial Autumn and Spring will be available for all students. These courses are offered by the Materials and Life Science Japanese Language Program but imparted in English. The credits obtained from these courses will not count for the required graduation credits.
- For a student to be able to register for Research Trial Autumn and Spring, the student must have previously passed; EXPERIMENTS & EXERCISE OF BASIC SCIENCE, MATERIALS AND LIFE SCIENCE LAB. A, and B. Additionally, the students are required to possess training on safety procedures equivalent to MATERIALS AND LIFE SCIENCE LAB. C.
 - There is an upper limit to the number of students that the teaching staff can accept each semester. In case that the registered students pass the upper limit, students will be accepted based on the student's grade.
 - Since these are optional courses their credits do not count as graduation credits, however the department strongly encourages the students to take this opportunity as a first-hand experience on research work.
 - For details, follow the instructions given by the department.

【For students who entered from 2015 to 2017】

- (1) Classification of Specialized Education (Gakka Kamoku)

Faculty of Science and Technology General Subject Group I:

These are fundamental courses taken by all students of the Faculty of Science and Technology. Courses in this group consist of compulsory courses (18 credits) and compulsory elective courses (English for Science and Engineering (2 credits)). Since the subjects Overview and Introduction to Science and Technology are no longer available, students that haven't obtained the credits for any of these subjects need to register in the following substitute subjects:

Overview of Science and Technology => Outline of Science and Technology
Introduction to Science and Technology => Basic Physics 1
Basic Physics => Basic Physics 2

Faculty of Science and Technology General Subject Group II:

This group is a continuation from Group I, which consists of common courses that form the foundation for studying specialized courses. While these courses are taken by all students of the Faculty of Science and Technology, some courses are particularly relevant for each department. Therefore, a number of courses are designated as compulsory elective courses by the department. To graduate, students need 26 credits from this particular group, including 6 credits from the compulsory elective courses.

Department Core Courses:

Courses in this group form the educational core of each department and include experiments, exercises, seminars, and graduation research. Some of the experiment-based and practical courses are compulsory elective courses while others are compulsory courses. A combined total of 16 credits from this group must be completed.

Department Specialized Courses:

These specialized courses offered by each department are electives. Students are required to take 32 credits from these courses in order to graduate.

(2) Credits Required for Graduation

To graduate, students are required to take a total of 94 credits from Specialized Education Courses (Gakka Kamoku): 31 credits from compulsory courses, 11 credits from compulsory elective courses, and 52 credits from elective courses.

(3) English for Science and Engineering

Students are required to take the compulsory elective course “ENGL. FOR SCI/ENGINEERING” from the Faculty of Science and Technology Common Subject Group I.

(4) Faculty of Science and Technology Common Subject Group II

Students must complete 6 credits or more from the compulsory elective courses in this group specified by their department. For students taking more than 6 credits, they can count the extra credits toward the Faculty of Science and Technology Common Subject Group II elective courses. Combined with extra credits from compulsory elective courses, students must take 20 credits from the elective courses in this group.

(5) Experiment-based and Practical Subjects from Department Core Courses

Students must take 13 credits from the compulsory courses in the Department Core Courses group. In addition, they must take 3 or more credits combined with compulsory elective courses from the Department Core Courses group other than English Courses.

(6) Department Specialized Courses

Students must take 32 credits or more from elective courses.

2) Registration Requirements for Graduation Research**【For students who entered from 2020】**

- (1) To register for Graduation Research I, the total number of remaining credits out of the minimum number of credits from courses required for graduation must be 14 or less, including the 4 credits for Graduation Research I and II, and Seminar I and II.
- (2) To register for Graduation Research I, students must have completed the compulsory experimental courses; Materials and Life Sciences Lab. A, Lab. B and Lab. C.
- (3) In principle, students take Graduation Research I in the autumn semester of the 4th year. Those who meet the above requirements and wish to take it in the following spring semester should inform their department.
- (4) To register for Graduation Research II, students must have completed Graduation Research I.
- (5) To register for Seminar I, registration of Graduation Research I must be already approved. In principle, students must take Graduation I and II, and Seminar I and II with the same instructor. Additionally, to register for Seminar II, it is required to have previously acquired Seminar I.

【For students who entered from 2015 to 2019】

- (1) To register for Graduation Research I, the total number of remaining credits out of the minimum number

of credits from courses required for graduation must be 20 or less, including the 2 credits for Graduation Research I and II.

- (2) To register for Graduation Research II, students must have completed Graduation Research I.
- (3) Generally, students take Graduation Research I in the autumn semester of the 4th year. Those who meet the above requirements and wish to take it in the following spring semester should inform their department.

3) Limit on the Number of Credits per Year/Semester

【For students who entered from 2022】

The following limitations apply to the number of credits that can be registered in each academic year and semester.

- (Note 1) Even if students are within the limits for registering credits in the autumn and spring semesters, the total number of credits registered in both semesters cannot exceed the annual limit.
- (Note 2) Those who have registered for the Teacher Certification Program are permitted to register for additional courses even though the limit for the semester has been exceeded after they have registered for the program, which is up to 6 credits in each semester (10 credits each year) from their 2nd year.
- (Note 3) Credits for Japanese Courses offered during Spring/Summer Recess will not be included in the maximum credit limit per year/semester (for FST English course students only).

(Credits)

1 st Year			2 nd Year			3 rd Year			4 th Year			Total
Aut	Spr	Annual Limit	Aut	Spr	Annual Limit	Aut	Spr	Annual Limit	Aut	Spr	Annual Limit	
27	27	49	27	27	49	27	27	49	27	27	49	196

※Spring: Spring • 1Q • 2Q courses, Autumn: Autumn • 3Q • 4Q courses

【For students who entered from 2015 to 2021】

The following limitations apply to the number of credits that can be registered in each academic year and semester.

- (Note 1) Even if students are within the limits for registering credits in the autumn and spring semesters, the total number of credits registered in both semesters cannot exceed the annual limit.
- (Note 2) Those who have registered for the Teacher Certification Program are permitted to register for additional courses even though the limit for the semester has been exceeded after they have registered for the program, which is up to 6 credits in each semester (10 credits each year) from their 2nd year.
- (Note 3) Credits for Japanese Courses offered during Spring/Summer Recess will not be included in the maximum credit limit per year/semester (for FST English course students only).

(Credits)

1 st Year			2 nd Year			3 rd Year			4 th Year			Total
Aut	Spr	Annual Limit	Aut	Spr	Annual Limit	Aut	Spr	Annual Limit	Aut	Spr	Annual Limit	
26	27	49	27	26	49	25	27	49	26	27	49	196

※Spring: Spring • 1Q • 2Q courses, Autumn: Autumn • 3Q • 4Q courses

【For students who entered in 2022】 Department of Material and Life Sciences (Green Science)

O General Studies: University-Wide General Studies (26 credits)

	1st Year		2nd Year		3rd Year		4th Year	
	Autumn Semester course title cr	Spring Semester course title cr	Autumn Semester course title cr	Spring Semester course title cr	Autumn Semester course title cr	Spring Semester course title cr	Autumn Semester course title cr	Spring Semester course title cr
Compulsory	8 cr	2						
Studies in Christian Humanism	Studies in Christian Humanism: For Others, With Others 1 Liberal Arts of the Body Thinking about Issues, Perspectives and Positivity 2	Critical Thinking & Discussion 2 Overview of Data Science 2						
Compulsory Electives	6 cr		Studies in Christian Humanism 2					
Electives	12 cr				Advanced General Education Courses			
					4			
					- General Studies Elective Courses - Freshmen may take General Studies Elective Courses up to 4 credits each semester - Japanese or any other Language (~8cr) - 100~200 level courses offered by FLA (p.71) - Credits earned in excess of 6 credits in Compulsory Electives will be counted into Electives.			

O Language (4credits)

	1st Year		2nd Year		3rd Year		4th Year	
	Autumn Semester course title cr	Spring Semester course title cr	Autumn Semester course title cr	Spring Semester course title cr	Autumn Semester course title cr	Spring Semester course title cr	Autumn Semester course title cr	Spring Semester course title cr
Compulsory	4cr	2	Academic Writing 1 2	Academic Writing 2 2				

O Specialized Education (Gakka Kamoku) (94credits)

	1st Year		2nd Year		3rd Year		4th Year	
	Autumn Semester course title cr	Spring Semester course title cr	Autumn Semester course title cr	Spring Semester course title cr	Autumn Semester course title cr	Spring Semester course title cr	Autumn Semester course title cr	Spring Semester course title cr
Faculty of Science and Technology General Subject Group I	16cr	1	2	2				
	MATHEMATICS A (LINEAR ALGEBRA)* 2 MATHEMATICS B (CALCULUS)* 2 EXPERIMENTS & EXERCISE OF BASIC SCIENCE 1 MATHEMATICS EXERCISE I* 1 OUTLINE OF SCIENCE & TECHNOLOGY 2 BASIC PHYSICS 1 2 BASIC BIOLOGY 2	BASIC CHEMISTRY 2 BASIC INFORMATICS 1						
Compulsory Elective	2cr							
		ENGL. FOR SCI/ENGINEERING (ENVIRONMENT) 2						
Faculty of Science and Technology General Subject Group II	8cr	2						
		BASIC PHYSICS 2 2						
Compulsory Elective	8cr							
		MOLECULAR BIOLOGY 2 ELECTROMAGNETISM 2 ORGANIC CHEMISTRY 2						
Elective	20cr							
		20 credits must be taken from the FST General Subject Group II elective courses. (Surplus credits from compulsory elective courses can be counted as elective courses.)						
Department Core Courses	13cr		2	2	1		1	1
		MATERIALS AND LIFE SCIENCES (PHYSICS) 2 MATERIALS AND LIFE SCIENCES (CHEMISTRY) 2 MATERIALS AND LIFE SCIENCES (BIOLOGY) 2 MATERIALS AND LIFE SCIENCES LAB. A 1			MATERIALS AND LIFE SCIENCES LAB. B 1		MATERIALS AND LIFE SCIENCES LAB. C 1	SEMINAR 1 GRADUATION RESEARCH 1 1
Compulsory Elective	3cr							
		CHEMISTRY LAB. 1 1 BIOLOGY LAB. 1 1 日本語のコア選必修科目 1						
Department Specialized Courses	32cr							
		22 credits must be taken from Department Specialized Courses. (Students can include up to 16 credits from the Department Specialized courses of other departments of FST and Japanese program of your department.)						

* The three mathematic courses marked with the asterisk should be taken together in the same semester.

【For students who entered from 2020 to 2021】 Department of Material and Life Sciences (Green Science)

O General Studies (Zengaku Kyotsu Kamoku) (26credits)

	1st Year		2nd Year		3rd Year		4th Year	
	Autumn Semester course title	Spring Semester course title	Autumn Semester course title	Spring Semester course title	Autumn Semester course title	Spring Semester course title	Autumn Semester course title	Spring Semester course title
Compulsory	2cr Health and Physical Education	2	cr	cr	cr	cr	cr	cr
Compulsory Elective	4cr Studies in Christian Humanism	4						
Elective	20cr							
	<ul style="list-style-type: none"> Japanese or any other Language (~8cr) 100-200 level courses offered by FLA (p.71) General Studies Elective Courses 							
	Advanced General Education Courses							
	2							

O Language (4credits)

	1st Year		2nd Year		3rd Year		4th Year	
	Autumn Semester course title	Spring Semester course title	Autumn Semester course title	Spring Semester course title	Autumn Semester course title	Spring Semester course title	Autumn Semester course title	Spring Semester course title
Compulsory	4cr Academic Writing 1	2	Academic Writing 2	2				

O Specialized Education (Gakka Kamoku) (94credits)

	1st Year		2nd Year		3rd Year		4th Year	
	Autumn Semester course title	Spring Semester course title	Autumn Semester course title	Spring Semester course title	Autumn Semester course title	Spring Semester course title	Autumn Semester course title	Spring Semester course title
Faculty of Science and Technology General Subject Group I	16cr							
	MATHEMATICS A (LINEAR ALGEBRA)*	2	BASIC CHEMISTRY	2	BASIC INFORMATICS	2		
	MATHEMATICS B (CALCULUS)*	2	EXPERIMENTS & EXERCISE OF BASIC SCIENCE	1				
	MATHEMATICS EXERCISE 1*	1	OUTLINE OF SCIENCE & TECHNOLOGY	2				
	BASIC PHYSICS 1	2						
	BASIC BIOLOGY	2						
Compulsory Elective	2cr							
			ENGL. FOR SCI/ENGINEERING (ENVIRONMENT)	2				
Faculty of Science and Technology General Subject Group II	8cr							
			BASIC PHYSICS 2	2				
			MOLECULAR BIOLOGY	2				
			ELECTROMAGNETISM	2				
			INORGANIC CHEMISTRY (ANALYTICAL CHEMISTRY)	2				
			ORGANIC CHEMISTRY	2				
Elective	20cr							
			20 credits must be taken from the FST General Subject Group II elective courses. (Surplus credits from compulsory elective courses can be counted as elective courses.)					
Department Core Courses	13cr							
			MATERIALS AND LIFE SCIENCES (PHYSICS)	2	MATERIALS AND LIFE SCIENCES LAB. B	1	MATERIALS AND LIFE SCIENCES LAB. C	1
			MATERIALS AND LIFE SCIENCES (CHEMISTRY)	2				
			MATERIALS AND LIFE SCIENCES (BIOLOGY)	2				
			MATERIALS AND LIFE SCIENCES LAB. A	1				
Compulsory Elective	3cr							
			CHEMISTRY LAB. 1	1	CHEMISTRY LAB. 2	1	CHEMISTRY LAB. 3	1
			BIOLOGY LAB. 1	1	PHYSICAL CHEMISTRY LAB. 1	1		
			日本語のコア選択必修科目	1	BIOLOGY LAB. 2	1	BIOLOGY LAB. 3	1
Department Specialized Courses	32cr							
			32 credits must be taken from Department Specialized Courses. (Students can include up to 16 credits from the Department Specialized Courses of other departments of FST and Japanese program of your department.)					

* The three mathematics courses marked with the asterisk mark should be taken together in the same semester.

【For students who entered from 2018 to 2019】 Department of Material and Life Sciences (Green Science)

O General Studies (Zengaku Kyotsu Kamoku) (26credits)

	1st Year		2nd Year		3rd Year		4th Year	
	Autumn Semester course title	Spring Semester course title	Autumn Semester course title	Spring Semester course title	Autumn Semester course title	Spring Semester course title	Autumn Semester course title	Spring Semester course title
Compulsory	2cr Health and Physical Education	2	cr	cr	cr	cr	cr	cr
Compulsory Elective	4cr Studies in Christian Humanism	4						
Elective	20cr							
	<ul style="list-style-type: none"> Japanese or any other Language (~8cr) 100~200 level courses offered by FLA (p.71) General Studies Elective Courses 							
	Advanced General Education Courses							
	2							

O Language (4credits)

	1st Year		2nd Year		3rd Year		4th Year	
	Autumn Semester course title	Spring Semester course title	Autumn Semester course title	Spring Semester course title	Autumn Semester course title	Spring Semester course title	Autumn Semester course title	Spring Semester course title
Compulsory	4cr Academic Skills 1	2	Academic Skills 2	2				

O Specialized Education (Gakka Kamoku) (94credits)

	1st Year		2nd Year		3rd Year		4th Year	
	Autumn Semester course title	Spring Semester course title	Autumn Semester course title	Spring Semester course title	Autumn Semester course title	Spring Semester course title	Autumn Semester course title	Spring Semester course title
Faculty of Science and Technology General Subject Group I	Compulsory 16cr	MATHEMATICS A (LINEAR ALGEBRA)*	2	BASIC CHEMISTRY	2	BASIC INFORMATICS	2	
		MATHEMATICS B (CALCULUS)*	2	EXPERIMENTS EXERCISE OF BASIC SCIENCE	1			
		MATHEMATICS EXERCISE I *	1	OUTLINE OF SCIENCE & TECHNOLOGY	2			
		BASIC PHYSICS 1	2	BASIC BIOLOGY	2			
Faculty of Science and Technology General Subject Group II	Compulsory Elective 8cr	ENGL. FOR SCI/ENGINEERING (ENVIRONMENT)		2	MOLECULAR BIOLOGY		2	
		BASIC PHYSICS 2		2	ELECTROMAGNETISM		2	
					INORGANIC CHEMISTRY (ANALYTICAL CHEMISTRY)		2	
Department Core Courses	Compulsory 13cr	MATERIALS AND LIFE SCIENCES (PHYSICS)		2	MATERIALS AND LIFE SCIENCES LAB B	1	MATERIALS AND LIFE SCIENCES LAB C	
		MATERIALS AND LIFE SCIENCES (CHEMISTRY)		2	MATERIALS AND LIFE SCIENCES (BIOLOGY)		2	
Department Specialized Courses	Compulsory Elective 3cr	MATERIALS AND LIFE SCIENCES LAB A		1	CHEMISTRY LAB. 1	1	CHEMISTRY LAB. 2	
					BIOLOGY LAB. 1	1	PHYSICAL CHEMISTRY LAB. 1	
Department Specialized Courses	Elective 32cr				日本語のコア選択必修科目	1	BIOLOGY LAB.2	
					BIOLOGY LAB.3	1		
20 credits must be taken from the FST General Subject Group II elective courses. (Surplus credits from compulsory elective courses can be counted as elective courses.)								
SEMINAR 1 (GRADUATION RESEARCH 1) 1 SEMINAR 2 (GRADUATION RESEARCH 2) 1								

* The three mathematic courses marked with the asterisk mark should be taken together in the same semester.

【For students who entered in 2017】 Department of Material and Life Sciences (Green Science)

O General Studies (Zengaku Kyotsu Kamoku) (26credits)

	1st Year		2nd Year		3rd Year		4th Year	
	Autumn Semester course title	Spring Semester course title	Autumn Semester course title	Spring Semester course title	Autumn Semester course title	Spring Semester course title	Autumn Semester course title	Spring Semester course title
Compulsory	2cr Health and Physical Education	2	cr	cr	cr	cr	cr	cr
Compulsory Elective	4cr Studies in Christian Humanism	4						
Elective	20cr	<ul style="list-style-type: none"> Japanese or any other Language (~8cr) 100~200 level courses offered by FLA (p.71) General Studies Elective Courses 						
Advanced General Education Courses								
2								

O Language (4credits)

	1st Year		2nd Year		3rd Year		4th Year	
	Autumn Semester course title	Spring Semester course title	Autumn Semester course title	Spring Semester course title	Autumn Semester course title	Spring Semester course title	Autumn Semester course title	Spring Semester course title
Compulsory	4cr Academic Skills 1	2	Academic Skills 2	2	cr	cr	cr	cr

O Specialized Education (Gakka Kamoku) (94credits)

	1st Year		2nd Year		3rd Year		4th Year	
	Autumn Semester course title	Spring Semester course title	Autumn Semester course title	Spring Semester course title	Autumn Semester course title	Spring Semester course title	Autumn Semester course title	Spring Semester course title
Faculty of Science and Technology General Subject Group I	Compulsory	18cr	2	BASIC PHYSICS※	2	BASIC INFORMATICS	2	
			2	BASIC CHEMISTRY	2			
			2	INTRO. TO SCIENCE & TECHNOLOGY※	2			
			2	MATHEMATICS A (LINEAR ALGEBRA)※	2			
		2	MATHEMATICS B (CALCULUS)※	2				
		2	MATHEMATICS EXERCISE 1*	1				
		2	BASIC BIOLOGY	2				
Faculty of Science and Technology General Subject Group II	Compulsory Elective	2cr	ENGL. FOR SCI/ENGINEERING (ENVIRONMENT)		2			
		6cr	MOLECULAR BIOLOGY		2			
			ELECTROMAGNETISM		2			
			ORGANIC CHEMISTRY		2			
Department Core Courses	Compulsory	13cr	20 credits must be taken from the FST General Subject Group II elective courses. (Surplus credits from compulsory elective courses can be counted as elective courses.)					
Department Specialized Courses	Compulsory Elective	32cr	32 credits must be taken from Department Specialized Courses. (Students can include up to 16 credits from the Department Specialized courses of other departments of FST and Japanese program of your department.)					

※ Since the subjects Overview and Introduction to Science and Technology are no longer available, students that haven't obtained the credits for any of these subjects need to register in the following substitute subjects:

Overview of Science and Technology ⇒ Outline of Science and Technology

Introduction to Science and Technology ⇒ Basic Physics 1, Basic Physics ⇒ Basic Physics 2

* The three mathematic courses marked with the asterisk mark should be taken together in the same semester.

Department of Engineering and Applied Sciences

Bachelor's Program in Green Engineering

Objectives of Education and Research

To foster students' ability to create entirely new values and functions by acquiring knowledge of materials, devices, energy, machinery, and systems, through an in-depth understanding of physics and mathematics.

Objectives of Human Resource Development

To nurture human resources who can, with a flexible mindset, apply and develop a wide range of knowledge and solid expertise acquired, so that they can contribute to solving various scientific and technological problems.

Diploma Policy

The Department of Engineering and Applied Sciences, aims to foster human resources with solid fundamental knowledge of science and technology who can contribute to the acquisition of new physical values and the development of ingenious technologies. With a view to this aim, the department sets standards for the skills and knowledge students should acquire before graduation as described below. Those who have fulfilled the requirements and have passed the thesis defense will be awarded a diploma.

1. The broad ability to address science and technology issues, acquired by studying the fundamentals of science and technology, including natural science disciplines.
2. The ability to contribute to the acquisition of new physical values and the creation of functions, nurtured by systematically studying physics, mechanical engineering and electrical and electronics engineering.
3. The ability to contribute to the development of ingenious technologies, acquired by studying physics, mechanical engineering and electrical and electronics engineering from the perspectives of “energy creation and use,” “understanding substances and creating materials and devices,” and “manufacturing and creating systems.”
4. The ability to pursue original research and thus contribute to the further advancement of science and technology, with the power to solve various science and technology issues acquired by theoretically and technologically applying and developing what one has learned.

Curriculum Policy

The Department of Engineering and Applied Sciences aims to foster the ability to contribute to society by acquiring “combined intelligence,” which is an integration of academic disciplines, such as “mechanical engineering,” “electrical and electronics engineering” and “physics,” and key themes, including “energy creation and use,” “understanding substances and creating materials and devices,” and “manufacturing and system building.” In light of this and in accordance with the diploma policy, the Department constructs its curriculum with courses aligned with the following purposes.

1. To acquire qualities that can accommodate the advancement of globalization through coursework in courses aimed at nurturing broad cultural knowledge and widening global perspectives, English courses and courses for the understanding of Christian humanism, offered as university-wide General Courses and Language Courses.
2. To acquire the fundamentals of the natural sciences in general, including physics, chemistry, biology, informatics, and mathematics through coursework in Science and Technology Category I General Courses to nurture broad capacities to address various science and technology issues.
3. To broadly study the fundamentals of science and technology associated with physics, mechanical engineering and electrical and electronics engineering; select a discipline from physics, mechanical engineering and electrical and electronics engineering based on coursework in lectures, as well as laboratory classes and seminars offered as Department Core Courses and Department Specialized Courses; and therefore, foster the ability to contribute to the acquisition of new physical values and creation of functions by systematically understanding each discipline. Also, to acquire science and technology-related English in order to be able to understand science and technology in English.
4. To acquire interdisciplinary abilities to apply and develop what has been learned in real society by using physics, mechanical engineering and electrical and electronics engineering. This is supported by allowing students to select lectures, laboratory classes and seminars from the perspectives of “energy creation and use,” “understanding substances and creating materials and devices,” and “manufacturing and system building”

based on lectures, laboratory classes and seminars in Department Core Courses and Department Specialized Courses.

5. To acquire the qualities of a researcher by gaining understanding of cutting-edge disciplines and presenting findings through graduate research and to acquire the ability to apply and develop what has been learned theoretically and technologically.

1. Courses and Minimum Number of Credits Required for Graduation

【For students who entered from 2022】

General Studies (Zengaku Kyotsu Kamoku)

Compulsory: 8 credits (Studies in Christian Humanism: For Others, With Others: 1 credit. Liberal Arts of The Body: 1 credit. Critical Thinking & Writing: 2 credits. Overview of Data Science: 2 credits. Thinking About Issues, Perspectives and Positionality: 2 credits.)

Compulsory electives: 6 credits (Studies in Christian Humanism: 2 credits. Advanced General Education Courses: 4 credits)

Electives: 12 credits

Language

Compulsory: 4 credits (English)

Specialized Education (Gakka Kamoku):

Compulsory: 26 credits

Compulsory electives: 25 credits

Electives: 43 credits

Total: 124 credits are required for graduation.

【For students who entered from 2018 to 2021】

General Studies (Zengaku Kyotsu Kamoku)

Compulsory: 2 credits (Health and Physical Education: 2 credits)

Compulsory electives: 4 credits (Studies in Christian Humanism)

Electives: 20 credits (including Advanced General Education Courses: 2 credits)

Language

Compulsory: 4 credits (English)

Specialized Education (Gakka Kamoku):

Compulsory: 26 credits

Compulsory electives: 25 credits

Electives: 43 credits

Total: 124 credits are required for graduation.

【For students who entered from 2016 to 2017】

General Studies (Zengaku Kyotsu Kamoku)

Compulsory: 2 credits (Health and Physical Education: 2 credits)

Compulsory electives: 4 credits (Studies in Christian Humanism)

Electives: 20 credits (including Advanced General Education Courses: 2 credits)

Language

Compulsory: 4 credits (English)

Specialized Education (Gakka Kamoku):

Compulsory: 28 credits

Compulsory electives: 23 credits

Electives: 43 credits

Total: 124 credits are required for graduation.

2. Distribution of Required Credits

Please see p.93 ~ 97

3. Precautions when Choosing Courses

1) Specialized Education (Gakka Kamoku)

【For students who entered from 2018】

(1) Classification of Specialized Education (Gakka Kamoku)

Faculty of Science and Technology General Subject Group I:

These are fundamental courses taken by all students of the Faculty of Science and Technology. Courses in this group consist of compulsory courses (16 credits) and compulsory elective courses (English for Science and Engineering (2 credits)).

Faculty of Science and Technology General Subject Group II:

This group is a continuation from Group I, which consists of common courses that form the foundation for studying specialized courses. While these courses are taken by all students of the Faculty of Science and Technology, some courses are particularly relevant for each department. Therefore, a number of courses are designated as compulsory elective courses by the department. To graduate, students need 27 credits from this particular group, including 16 credits from the compulsory elective courses.

Department Core Courses:

Courses in this group form the core elements of study of each department and include experiments, exercises, seminars, Research Trial Spring, Autumn and graduation research. Some experiment-based and practical courses are compulsory elective courses while others are compulsory courses. A combined total of 17 credits from this group must be completed. Since 2021, Research Trial Spring, Autumn have been established for 3rd year students. The purpose of these courses is to provide the students an early-stage experience of actual research activities within the department, to earn deep understanding on how to approach research activities and specialized subjects of the department.

Department Specialized Courses:

These specialized courses offered by each department are electives. Students are required to take 32 credits from these courses in order to graduate.

(2) Credits Required for Graduation

To graduate, students are required to take a total of 94 credits from Specialized Education (Gakka Kamoku): 26 credits from compulsory courses, 25 credits from compulsory elective courses, and 43 credits from elective courses.

(3) English for Science and Engineering

Students are required to take the compulsory elective course “ENGL. FOR SCI/ENGINEERING” from the Faculty of Science and Technology General Subject Group I.

(4) Faculty of Science and Technology General Subject Group II

Students must complete 16 credits or more from the compulsory elective courses in this group specified by their department. For students taking more than 16 credits, they can count the excess credits toward the Faculty of Science and Technology General Subject Group II elective courses. Combined with extra credits from compulsory elective courses, students must take 11 credits from the elective courses in this group.

(5) Experiment-based and Practical Subjects from Department Core Courses

Students must obtain 10 credits from the compulsory courses in the Department Core Courses group. In addition, they must take 7 or more credits combined with compulsory elective courses from the Department Core Courses group other than English Courses.

(6) Department Specialized Courses

Students must take 32 credits or more from elective courses.

(7) Optional Courses within the Department Specialized Courses

Since 2021, the courses Research Trial Spring, Autumn became available for all students. These courses are offered by the Japanese Program but imparted in English. The credits obtained from these courses will not be counted for the required graduation credits.

- a) For a student be able to register Research Trial Spring, Autumn, it must have previously passed; Experiments & Exercise of Basic Science, Engineering and Applied Sciences Lab. 1 and 2. Moreover, it must have registered Green Engineering Lab. 1.
- b) There is an upper limit to the number of students that the teaching staff can take each semester. In case that the number of registered students exceeds the upper limit, students will be selected based on the student's grade.
- c) Since these are optional courses, their credits are not counted as graduation credits. However, the department strongly encourages the students to take this opportunity for first-hand experience on research work.
- d) For details, follow the instructions given by the department.

1) Specialized Education (Gakka Kamoku)**【For students who entered from 2016 to 2017】****(1) Classification of Specialized Education (Gakka Kamoku)**

Faculty of Science and Technology General Subject Group I:

These are fundamental courses taken by all students of the Faculty of Science and Technology. Courses in this group consist of compulsory courses (18 credits) and compulsory elective courses (English for Science and Engineering (2 credits)). Since the subjects Overview and Introduction to Science and Technology are no longer available, students that haven't obtained the credits for any of these subjects need to register in the following substitute subjects:

Overview of Science and Technology => Outline of Science and Technology
 Introduction to Science and Technology => Basic Physics 1
 Basic Physics => Basic Physics 2

Faculty of Science and Technology General Subject Group II:

This group is a continuation from Group I, which consists of common courses that form the foundation for studying specialized courses. While these courses are taken by all students of the Faculty of Science and Technology, some courses are particularly relevant for each department. Therefore, a number of courses are designated as compulsory elective courses by the department. To graduate, students need 25 credits from this particular group, including 14 credits from the compulsory elective courses.

Department Core Courses:

Courses in this group form the core elements of study of each department and include experiments, exercises, seminars and graduation research. Some experiment-based and practical courses are compulsory elective courses while others are compulsory courses. A combined total of 17 credits from this group must be completed.

Department Specialized Courses:

These specialized courses offered by each department are electives. Students are required to take 32 credits from these courses in order to graduate.

(2) Credits Required for Graduation

To graduate, students are required to take a total of 94 credits from Specialized Education (Gakka Kamoku): 28 credits from compulsory courses, 23 credits from compulsory elective courses, and 43 credits from elective courses.

- (3) English for Science and Engineering
Students are required to take the compulsory elective course “ENGL. FOR SCI/ENGINEERING” from the Faculty of Science and Technology General Subject Group I.
- (4) Faculty of Science and Technology General Subject Group II
Students must complete 14 credits or more from the compulsory elective courses in this group specified by their department. For students taking more than 14 credits, they can count the excess credits toward the Faculty of Science and Technology General Subject Group II elective courses. Combined with extra credits from compulsory elective courses, students must take 11 credits from the elective courses in this group.
- (5) Experiment-based and Practical Subjects from Department Core Courses
Students must obtain 10 credits from the compulsory courses in the Department Core Courses group. In addition, they must take 7 or more credits combined with compulsory elective courses from the Department Core Courses group other than English Courses.
- (6) Department Specialized Courses
Students must take 32 credits or more from elective courses.

2) Registration Requirements for Graduation Research

- (1) To register for Graduation Research I, the total number of remaining credits out of the minimum number of credits from subjects required for graduation (124 credits) must be 20 or fewer, including 2 credits from Graduation Research I and II.
- (2) To register for Graduation Research II, students must have completed Graduation Research I.
- (3) Generally, students take Graduation Research I in the autumn semester of the 4th year. Those who meet the above requirements and wish to take it in the following spring semester should inform their department.

3) Limit on the Number of Credits per Year/Semester

【For students who entered from 2022】

The following limitations apply to the number of credits that can be registered in each academic year and semester.

(Note 1) Even if students are within the limits for registering credits in the autumn and spring semesters, the total number of credits registered in both semesters cannot exceed the annual limit.

(Note 2) Those who have registered for the Teacher Certification Program are permitted to register for additional courses even though the limit for semester has been exceeded after they have registered for the program, which is up to 6 credits in each semester (10 credits per year) from their 2nd year.

(Note 3) Credits for Japanese Courses offered during Spring/Summer Recess will not be included in the maximum credit limit per year/semester (for FST English course students only).

(Credits)

1 st Year			2 nd Year			3 rd Year			4 th Year			Total
Aut	Spr	Annual Limit	Aut	Spr	Annual Limit	Aut	Spr	Annual Limit	Aut	Spr	Annual Limit	
27	27	49	27	27	49	27	27	49	27	27	49	196

※Spring: Spring · 1Q · 2Q courses, Autumn: Autumn · 3Q · 4Q courses

3) Limit on the Number of Credits per Year/Semester 【For students who entered from 2016 to 2021】

The following limitations apply to the number of credits that can be registered in each academic year and semester.

(Note 1) Even if students are within the limits for registering credits in the autumn and spring semesters, the total number of credits registered in both semesters cannot exceed the annual limit.

(Note 2) Those who have registered for the Teacher Certification Program are permitted to register for additional courses even though the limit for semester has been exceeded after they have registered for the program, which is up to 6 credits in each semester (10 credits per year) from their 2nd year.

(Note 3) Credits for Japanese Courses offered during Spring/Summer Recess will not be included in the maximum credit limit per year/semester (for FST English course students only).

(Credits)

1 st Year			2 nd Year			3 rd Year			4 th Year			Total
Aut	Spr	Annual Limit	Aut	Spr	Annual Limit	Aut	Spr	Annual Limit	Aut	Spr	Annual Limit	
26	27	49	27	26	49	25	27	49	26	27	49	196

※Spring: Spring • 1Q • 2Q courses, Autumn: Autumn • 3Q • 4Q courses

【For students who entered in 2022】 Department of Engineering and Applied Sciences (Green Engineering)

○ General Studies (Zengaku Kyotsu Kamoku) (26credits)

	1st Year		2nd Year		3rd Year		4th Year	
	Autumn Semester course title	Spring Semester course title	Autumn Semester course title	Spring Semester course title	Autumn Semester course title	Spring Semester course title	Autumn Semester course title	Spring Semester course title
Compulsory	8cr Studies in Christian Humanism: For Others, With Others Liberal Arts of the Body Thinking about Issues, Perspectives and Positionality	1 Critical Thinking & Discussion 2 Overview of Data Science	2					
Compulsory Electives	6cr Studies in Christian Humanism Advanced General Education Courses		2					4
Electives	12cr General Studies Elective Courses Freshmen may take General Studies Elective Courses up to 4 credits each semester - Japanese or any other Language (~8cr) - 100-200 level courses offered by FLA (p.71) - Credits earned in excess of 6 credits in Compulsory Electives will be counted into Electives.							

○ Language (4credits)

	1st Year		2nd Year		3rd Year		4th Year	
	Autumn Semester course title	Spring Semester course title	Autumn Semester course title	Spring Semester course title	Autumn Semester course title	Spring Semester course title	Autumn Semester course title	Spring Semester course title
Compulsory	4cr Academic Writing 1	2 Academic Writing 2						

○ Specialized Education (Gaikka Kamoku) (94credits)

	1st Year		2nd Year		3rd Year		4th Year	
	Autumn Semester course title	Spring Semester course title	Autumn Semester course title	Spring Semester course title	Autumn Semester course title	Spring Semester course title	Autumn Semester course title	Spring Semester course title
Faculty of Science and Technology General Subject Group I	16cr MATHEMATICS A (LINEAR ALGEBRA)* MATHEMATICS B (CALCULUS)* MATHEMATICS EXERCISE 1* OUTLINE OF SCIENCE & TECHNOLOGY BASIC PHYSICS 1	2 BASIC CHEMISTRY 2 BASIC BIOLOGY 1 EXPERIMENTS & EXERCISE OF BASIC SCIENCE	2 BASIC INFORMATICS	2				
Compulsory Elective	2cr ENGL. FOR SCI/ENGINEERING (ENVIRONMENT)			2				
Faculty of Science and Technology General Subject Group II	16cr BASIC PHYSICS 2	2 MATHEMATICS BY CALCULUS OF SEVERAL VARIABLES 2 BASIC DIFFERENTIAL EQUATIONS SCIENCE, TECHNOLOGY AND ENVIRONMENT	2 FOURIER & LAPLACE TRANSFORMS 2 GEOSCIENCE 2 THERMODYNAMICS 2 ATMOSPHERIC CHEMISTRY 2 ATOMIC & MOLECULAR SCIENCES 2 ELECTROMAGNETISM	2 2 2 2 2 2 2				
Elective	11cr ENGINEERING AND APPLIED SCIENCES 1 ENGINEERING AND APPLIED SCIENCES 2 ENGINEERING AND APPLIED SCIENCES 3 ENGINEERING AND APPLIED SCIENCES LAB. 1			11 credits must be taken from the FST General Subject Group II elective courses. (Surplus credits from compulsory elective courses can be counted as elective courses.)				
Department Core Courses	7cr Compulsory Elective							
Department Specialized Courses	32cr Elective							

32 credits must be taken from Department Specialized Courses.
(Students can include up to 16 credits from the Department Specialized courses of other departments of FST and Japanese program of your department.)

* The three mathematic courses marked with the asterisk mark should be taken together in the same semester.

【For students who entered from 2020 to 2021】 Department of Engineering and Applied Sciences (Green Engineering)

○General Studies (Zengaku Kyotsu Kamoku) (26credits)

	1st Year		2nd Year		3rd Year		4th Year		
	Autumn Semester course title	Spring Semester course title	Autumn Semester course title	Spring Semester course title	Autumn Semester course title	Spring Semester course title	Autumn Semester course title	Spring Semester course title	
Compulsory	2cr Health and Physical Education	2							
Compulsory Elective	4cr Studies in Christian Humanism	4							
Elective	20cr		<ul style="list-style-type: none"> Japanese or any other Language (~8cr) 100-200 level courses offered by FLA (p.71) General Studies Elective Courses 						
	Advanced General Education Courses							2	

○Language (4credits)

	1st Year		2nd Year		3rd Year		4th Year	
	Autumn Semester course title	Spring Semester course title	Autumn Semester course title	Spring Semester course title	Autumn Semester course title	Spring Semester course title	Autumn Semester course title	Spring Semester course title
Compulsory	4cr Academic Writing 1	2	2 Academic Writing 2	2				

○Specialized Education (Gaikka Kamoku) (94credits)

	1st Year		2nd Year		3rd Year		4th Year		
	Autumn Semester course title	Spring Semester course title	Autumn Semester course title	Spring Semester course title	Autumn Semester course title	Spring Semester course title	Autumn Semester course title	Spring Semester course title	
Faculty of Science and Technology General Subject Group I	Compulsory	16cr	MATHEMATICS A (LINEAR ALGEBRA)* 2 MATHEMATICS B (CALCULUS)* 2 MATHEMATICS EXERCISE 1* 1 OUTLINE OF SCIENCE & TECHNOLOGY 2 BASIC PHYSICS 1 2	2 BASIC CHEMISTRY 2 BASIC BIOLOGY 1 EXPERIMENTS & EXERCISE OF BASIC SCIENCE	2 BASIC INFORMATICS				
	Compulsory Elective	2cr				ENGL. FOR SCI/ENGINEERING (ENVIRONMENT) 2			
Faculty of Science and Technology General Subject Group II	Compulsory Elective	16cr	BASIC PHYSICS 2	MATHEMATICS B3 (CALCULUS OF SEVERAL VARIABLES) 2 BASIC DIFFERENTIAL EQUATIONS 2 SCIENCE, TECHNOLOGY AND ENVIRONMENT 2	MATHEMATICS C1 (STATISTICAL DATA ANALYSIS) 2 MOLECULAR BIOLOGY 2 THERMODYNAMICS 2 ATOMIC & MOLECULAR SCIENCES 2 ELECTROMAGNETISM 2	FOURIER & LAPLACE TRANSFORMS 2 GEOSCIENCE 2 ATMOSPHERIC CHEMISTRY 2			
	Elective	11cr				11 credits must be taken from the FST General Subject Group II elective courses. (Surplus credits from compulsory elective courses can be counted as elective courses.)			
Department Core Courses	Compulsory	10cr	ENGINEERING AND APPLIED SCIENCES 1 2 ENGINEERING AND APPLIED SCIENCES 2 2 ENGINEERING AND APPLIED SCIENCES 3 2 ENGINEERING AND APPLIED SCIENCES LAB. 1 1			ENGINEERING AND APPLIED SCIENCES LAB. 2 1	GRADUATION RESEARCH 1 1	GRADUATION RESEARCH 2 1	
	Compulsory Elective	7cr				GREEN ENGINEERING LAB. 1 1 TOPICS OF GREEN ENGINEERING 1** 2 TOPICS OF GREEN ENGINEERING 2 2 日本語のコア選択必修科目 1-2	GREEN ENGINEERING LAB. 3 1		
Department Specialized Courses	Elective	32cr	32 credits must be taken from Department Specialized Courses. (Students can include up to 16 credits from the Department. Specialized courses of other departments of FST and Japanese program of your department.)						

* The three mathematic courses marked with the asterisk mark should be taken together in the same semester.

** For students who entered in 2020, this course will be offered in Spring semester of 2nd Year.

【For students who entered from 2018 to 2019】 Department of Engineering and Applied Sciences (Green Engineering)

○General Studies (Zengaku Kyotsu Kamoku) (26credits)

	1st Year		2nd Year		3rd Year		4th Year			
	Autumn Semester course title	Spring Semester course title	Autumn Semester course title	Spring Semester course title	Autumn Semester course title	Spring Semester course title	Autumn Semester course title	Spring Semester course title		
Compulsory	2cr Health and Physical Education	2	cr	cr	cr	cr	cr	cr		
Compulsory Elective	4cr Studies in Christian Humanism	4								
Elective	20cr • Japanese or any other Language (~8cr) • 100-200 level courses offered by FLA (p.71) • General Studies Elective Courses									
								Advanced General Education Courses		2

○Language (4credits)

	1st Year		2nd Year		3rd Year		4th Year	
	Autumn Semester course title	Spring Semester course title	Autumn Semester course title	Spring Semester course title	Autumn Semester course title	Spring Semester course title	Autumn Semester course title	Spring Semester course title
Compulsory	4cr Academic Skills 1	2	Academic Skills 2	2				

○Specialized Education (Gakka Kamoku) (94credits)

	1st Year		2nd Year		3rd Year		4th Year		
	Autumn Semester course title	Spring Semester course title	Autumn Semester course title	Spring Semester course title	Autumn Semester course title	Spring Semester course title	Autumn Semester course title	Spring Semester course title	
Faculty of Science and Technology General Subject Group I	Compulsory	16cr MATHEMATICS A (LINEAR ALGEBRA)* MATHEMATICS B (CALCULUS)* MATHEMATICS EXERCISE 1* OUTLINE OF SCIENCE & TECHNOLOGY BASIC PHYSICS 1	2 2 1 2	2 2 1	2 2 2	BASIC INFORMATICS	2		
	Compulsory Elective	2cr				ENGL. FOR SCI./ENGINEERING (ENVIRONMENT)	2		
	Compulsory Elective	16cr	2 2 2 2	2 2 2 2	2 2 2 2	BASIC PHYSICS 2 MATHEMATICS OF SEVERAL VARIABLES BASIC DIFFERENTIAL EQUATIONS SOCIAL, REGIONAL AND LOCAL ENVIRONMENTAL ISSUES SCIENCE, TECHNOLOGY AND ENVIRONMENT	2 2 2 2	2 2 2 2	
	Elective	11cr					FOURIER & LAPLACE TRANSFORMS GEOSCIENCE THERMODYNAMICS ATOMIC & MOLECULAR SCIENCES ELECTROMAGNETISM	2 2 2 2 2	
Department Core Courses	Compulsory	10cr	2 2 2 2	2 2 2 2	2 2 2 2	ENGINEERING AND APPLIED SCIENCES 1 ENGINEERING AND APPLIED SCIENCES 2 ENGINEERING AND APPLIED SCIENCES 3 ENGINEERING AND APPLIED SCIENCES LAB. 1	1 1 1 1	GRADUATION RESEARCH 1 GRADUATION RESEARCH 2	1 1
	Compulsory Elective	7cr				GREEN ENGINEERING LAB. 1 TOPICS OF GREEN ENGINEERING 1 TOPICS OF GREEN ENGINEERING 2 日本語のコア選択必修科目	1 2 2	1 2 2	1 1
	Elective	32cr							

32 credits must be taken from Department Specialized Courses.
(Students can include up to 16 credits from the Department Specialized courses of other departments of FST and Japanese program of your department.)

* The three mathematic courses marked with the asterisk mark should be taken together in the same semester.

【For students who entered in 2017】 Department of Engineering and Applied Sciences (Green Engineering)

O General Studies (Zengaku Kyotsu Kamoku) (26credits)

	1st Year		2nd Year		3rd Year		4th Year	
	Autumn Semester course title	Spring Semester course title	Autumn Semester course title	Spring Semester course title	Autumn Semester course title	Spring Semester course title	Autumn Semester course title	Spring Semester course title
Compulsory	2cr Health and Physical Education	2						
Compulsory Elective	4cr Studies in Christian Humanism	4						
Elective	• Japanese or any other Language (~8cr) • 100~200 level courses offered by FLA (p.71) • General Studies Elective Courses							
Advanced General Education Courses								
	2							

O Language (4credits)

	1st Year		2nd Year		3rd Year		4th Year	
	Autumn Semester course title	Spring Semester course title	Autumn Semester course title	Spring Semester course title	Autumn Semester course title	Spring Semester course title	Autumn Semester course title	Spring Semester course title
Compulsory	4cr Academic Skills 1	2 Academic Skills 2						

O Specialized Education (Gakka Kamoku) (94credits)

	1st Year		2nd Year		3rd Year		4th Year		
	Autumn Semester course title	Spring Semester course title	Autumn Semester course title	Spring Semester course title	Autumn Semester course title	Spring Semester course title	Autumn Semester course title	Spring Semester course title	
Faculty of Science and Technology General Subject Group I	Compulsory	18cr	OVERVIEW OF SCIENCE & TECHNOLOGY※ INTRO. TO SCIENCE & TECHNOLOGY※ MATHEMATICS A (LINEAR ALGEBRA)※ MATHEMATICS B (CALCULUS)※ MATHEMATICS EXERCISE I※	2	BASIC INFORMATICS				
		2cr	ENGL. FOR SCI/ENGINEERING (ENVIRONMENT)	2					
Faculty of Science and Technology General Subject Group II	Compulsory Elective	14cr	MATHEMATICS BY CALCULUS OF SEVERAL VARIABLES) BASIC DIFFERENTIAL EQUATIONS GLOBAL REGIONAL AND LOCAL ENVIRONMENTAL ISSUES SCIENCE, TECHNOLOGY AND ENVIRONMENT	2	ENGL. FOR SCI/ENGINEERING (ENVIRONMENT) MATHEMATICS C1 (STATISTICAL DATA ANALYSIS) FOURIER & LAPLACE TRANSFORMS GEOSCIENCE THERMODYNAMICS ATOMIC & MOLECULAR SCIENCES ELECTROMAGNETISM	2	2	2	
		11cr	11 credits must be taken from the FST General Subject Group II elective courses. (Surplus credits from compulsory elective courses can be counted as elective courses.)						
Department Core Courses	Compulsory	10cr	ENGINEERING AND APPLIED SCIENCES 1 ENGINEERING AND APPLIED SCIENCES 2 ENGINEERING AND APPLIED SCIENCES 3 ENGINEERING AND APPLIED SCIENCES LAB. 1	2		1			
		7cr	GREEN ENGINEERING LAB. 1 TOPICS OF GREEN ENGINEERING 1 TOPICS OF GREEN ENGINEERING 2 日本語のコア選択必修科目	1	2	2	1	1	
Department Specialized Courses	Elective	32cr	32 credits must be taken from Department Specialized Courses. (Students can include up to 16 credits from the Department Specialized courses of other departments of FST and Japanese program of your department.)						

※ Since the subjects Overview and Introduction to Science and Technology are no longer available, students that haven't obtained the credits for any of these subjects need to register in the following substitute subjects:
 Overview of Science and Technology => Outline of Science and Technology
 Introduction to Science and Technology => Basic Physics 1, Basic Physics 2

* The three mathematic courses marked with the asterisk mark should be taken together in the same semester.

【For students who entered in 2016】 Department of Engineering and Applied Sciences (Green Engineering)

O General Studies (Zengaku Kyotsu Kamoku) (26credits)

	1st Year		2nd Year		3rd Year		4th Year	
	Autumn Semester course title	Spring Semester course title	Autumn Semester course title	Spring Semester course title	Autumn Semester course title	Spring Semester course title	Autumn Semester course title	Spring Semester course title
Compulsory	2cr Health and Physical Education	2						
Compulsory/Elective	4cr Studies in Christian Humanism	4						
Elective	20cr							
・ Japanese or any other Language (~8cr) ・ 100-200 level courses offered by FLA (p.71) ・ General Studies Elective Courses								
Advanced General Education Courses								
2								

O Language (4credits)

	1st Year		2nd Year		3rd Year		4th Year	
	Autumn Semester course title	Spring Semester course title	Autumn Semester course title	Spring Semester course title	Autumn Semester course title	Spring Semester course title	Autumn Semester course title	Spring Semester course title
Compulsory	4cr Academic Skills 1	2	Academic Skills 2	2				

O Specialized Education (Gakka Kamoku) (94credits)

	1st Year		2nd Year		3rd Year		4th Year	
	Autumn Semester course title	Spring Semester course title	Autumn Semester course title	Spring Semester course title	Autumn Semester course title	Spring Semester course title	Autumn Semester course title	Spring Semester course title
Faculty of Science and Technology General Subject Group I	OVERVIEW OF SCIENCE & TECHNOLOGY※	2	MATHEMATICS A (LINEAR ALGEBRA)※	2	BASIC INFORMATICS	2		
	INTRO. TO SCIENCE & TECHNOLOGY※	2	MATHEMATICS B (CALCULUS)※	2				
Compulsory	18cr		MATHEMATICS EXERCISE 1*	1				
			BASIC PHYSICS※	2				
Compulsory Elective	2cr		BASIC CHEMISTRY	2				
			BASIC BIOLOGY	2				
Faculty of Science and Technology General Subject Group II	ENGL. FOR SCI/ENGINEERING (ENVIRONMENT)	2						
			MATHEMATICS OF SEVERAL VARIABLES	2				
Compulsory Elective	14cr		BASIC DIFFERENTIAL EQUATIONS	2	MOLECULAR BIOLOGY	2	FOURIER & LAPLACE TRANSFORMS	2
			GLOBAL, REGIONAL AND LOCAL ENVIRONMENTAL ISSUES	2	THERMODYNAMICS	2	GEOSCIENCE	2
Elective	11cr		SCIENCE, TECHNOLOGY AND ENVIRONMENT	2	ATOMIC & MOLECULAR SCIENCES	2	ATMOSPHERIC CHEMISTRY	2
			EXPERIMENTS & EXERCISE OF BASIC SCIENCE	1	ELECTROMAGNETISM	2		
Department Core Courses	11 credits must be taken from the FST General Subject Group II elective courses. (Surplus credits from compulsory elective courses can be counted as elective courses.)							
Department Specialized Courses	10cr		ENGINEERING AND APPLIED SCIENCES 1	2	ENGINEERING AND APPLIED SCIENCES LAB. 2	1	ENGINEERING RESEARCH 1	1
			ENGINEERING AND APPLIED SCIENCES 2	2	ENGINEERING AND APPLIED SCIENCES 3	2	ENGINEERING RESEARCH 2	1
Department Specialized Courses	7cr		ENGINEERING AND APPLIED SCIENCES LAB. 1	1	GREEN ENGINEERING LAB. 1	1	GREEN ENGINEERING LAB. 2	1
					TOPICS OF GREEN ENGINEERING 1	2	TOPICS OF GREEN ENGINEERING 2	2
					日本語のエア選択必修科目	1~4		
Department Specialized Courses	32cr		32 credits must be taken from Department Specialized Courses. (Students can include up to 16 credits from the Department Specialized Courses of other departments of FST and Japanese program of your department.)					

※ Since the subjects Overview and Introduction to Science and Technology are no longer available, students that haven't obtained the credits for any of these subjects need to register in the following substitute subjects:
 Overview of Science and Technology => Outline of Science and Technology
 Introduction to Science and Technology => Basic Physics 1, Basic Physics => Basic Physics 2

* The three mathematic courses marked with the asterisk mark should be taken together in the same semester.

Course List

Common Subjects in the Faculty of Science and Technology

	Course No.	Numbering	Course title	Cr.	Semester offered	Instructor	Student Year	Remarks
Faculty of Science and Technology Common Subject Group I	SCT1020E	SCT101-75e00	OUTLINE OF SCIENCE & TECHNOLOGY	2	AUT	THOMAS, Morgan Leslie	1	◇
	SCT1150E	MTH101-75e00	MATHEMATICS A (LINEAR ALGEBRA)	2	AUT	TRIHAN, Fabien	1	
	SCT1160E	MTH102-75e00	MATHEMATICS B (CALCULUS)	2	AUT	TRIHAN, Fabien	1	
	SCT1170E	MTH103-75e00	MATHEMATICS EXERCISE 1	1	AUT	TRIHAN, Fabien	1	
	SCT1030E	PHY101-75e00	BASIC PHYSICS I	2	3Q	DZIEMINSKA, Edyta	1	●
	SCT1190E	CHM101-75e00	BASIC CHEMISTRY	2	SPR	MISAWA / THOMAS	1	
	SCT1200E	BIO101-75e00	BASIC BIOLOGY	2	4Q	NIKURA, Takako	1	
	SCT2030E	MTH104-75e00	BASIC INFORMATICS	2	AUT	TAKAOKA, Eiko	2	
	SCT1210E	SCT102-75e00	EXPERIMENTS & EXERCISE OF BASIC SCIENCE	1	SPR	DANIELACHE / SUZUKI / BANDAI / LI	1	
	SCT5130E	SCT203-75e00	ENGL. FOR SCI / ENGINEERING (ENVIRONMENT)	2	SPR	THOMAS, Morgan Leslie	2	
Faculty of Science and Technology Common Subject Group II	SCT1220E	PHY102-75e00	BASIC PHYSICS II	2	SPR	ZHANG, Weilu	1~2	S, E, ■
	SCT6690E	MTH201-75e00	MATHEMATICS C1 (STATISTICAL DATA ANALYSIS)	2	SPR	GOTO, Satoshi	2	[48], E
	SCT6650E	BIO102-75e00	MOLECULAR BIOLOGY	2	SPR	FUJIWARA / SUZUKI	2	S, E
	SCT6700E	MTH105-75e00	MATHEMATICS B2 (CALCULUS OF SEVERAL VARIABLES)	2	AUT	LARANGEIRA Mario*	2	E
	SCT6710E	MTH106-75e00	BASIC DIFFERENTIAL EQUATIONS	2	AUT	ARAI, Mamiko*	2	E
	SCT6660E	CHM102-75e00	INORGANIC CHEMISTRY (ANALYTICAL CHEMISTRY)	2	SPR	THOMAS, Morgan Leslie	2	S
	SCT6800E	CHM103-75e00	ORGANIC CHEMISTRY	2	SPR	SUZUKI, Yumiko	2	S
	SCT6810E	CHM202-75e00	PHYSICAL CHEMISTRY	2	AUT	NANBU, Shinkoh	2~4	
	SCT6730E	MTH202-75e00	FOURIER & LAPLACE TRANSFORMS	2	AUT	ARAI, Mamiko*	3	E
	SCT6740E	PHY202-75e00	THERMODYNAMICS	2	SPR	ZHANG, Weilu	2	E
	SCT6750E	BIO201-75e00	CELL BIOLOGY	2	AUT	HAYASHI, Kensuke	2~4	
	SCT6760E	PHY203-75e00	INTRODUCTION TO QUANTUM MECHANICS	2	AUT	ZHANG, Weilu	2~4	
	SCT6770E	PHY204-75e00	ATOMIC & MOLECULAR SCIENCES	2	SPR	KUMA, Susumu*	2	E
	SCT6780E	CHM201-75e00	GEOSCIENCE	2	Not Offered		3	E, ☆
	SCT6820E	CHM203-75e00	ATMOSPHERIC CHEMISTRY	2	4Q	DANIELACHE, Sebastian	3	E, ☆
	SCT6685E	PHY201-75e00	ELECTROMAGNETISM	2	SPR	ZHANG, Weilu	2	S, E
	SCT6840E	SCT204-75e00	SCIENCE, TECHNOLOGY AND ENVIRONMENT	2	AUT	FUJITA / KUROE / SUZUKI / DZIEMINSKA / NAKAMURA	2	E
	SCT6830E	BIO202-75e00	FUNDAMENTAL BIOCHEMISTRY	2	SPR	KONDO, Jiro/YAMADO, Yoko	2~4	
SCT6850E	SCT205-75e00	TECHNOLOGY & INNOVATION - CAREER DEVELOPMENT -	2	SPR	KONDO, Jiro/ Others	2~4	Intensive Course	

[] = Lottery Courses. Number in brackets is the capacity.

Instructor's name with * = adjunct instructor

★ = Course taught by invited visiting professor

S = Compulsory Elective for Green Science Course Students

E = Compulsory Elective for Green Engineering Course Students

● = This course cannot be registered by students that have already registered in INTRO. TO SCIENCE & TECHNOLOGY

◇ = This course cannot be registered by students that have already registered in OVERVIEW OF SCIENCE AND TECHNOLOGY

■ = This course cannot be registered by students that have already registered in BASIC PHYSICS

☆ = Every Other Year

Course List

Department of Materials and Life Sciences (Green Science)

	Course No.	Numbering	Course title	Cr.	Semester offered	Instructor	Student Year	Remarks
Department Core Courses	SML2040E	PHY101-76e00	MATERIALS AND LIFE SCIENCES (PHYSICS)	2	AUT	ZHANG, Weilu	2	
	SML2050E	CHM101-76e00	MATERIALS AND LIFE SCIENCES (CHEMISTRY)	2	3Q	DANIELACHE, Sebastian	2	
	SML2060E	BIO101-76e00	MATERIALS AND LIFE SCIENCES (BIOLOGY)	2	AUT	KAWAGUCHI / YAMADA	2	
	SML2070E	MLS101-76e00	MATERIALS AND LIFE SCIENCES LAB. A	1	AUT	DANIELACHE / YAMADA	2	
	SML2080E	MLS201-76e00	MATERIALS AND LIFE SCIENCES LAB. B	1	SPR	THOMAS, Morgan Leslie	2	
	SML3030E	MLS202-76e00	MATERIALS AND LIFE SCIENCES LAB. C	1	3Q	THOMAS, Morgan Leslie	3	
	SML5130E	CHM201-76e00	CHEMISTRY LAB. 1	1	4Q	THOMAS, Morgan Leslie	3	
	SML5140E	CHM301-76e00	CHEMISTRY LAB. 2	1	1Q	SUZUKI / USUKI / TAKEOKA	3	
	SML5150E	MLS303-76e00	PHYSICAL CHEMISTRY LAB.	1	2Q	OKADA / KUZE / NANBU	3	
	SML5210E	BIO201-76e00	BIOLOGY LAB. 1	1	4Q	YAMADA, Yoko	3	
	SML5220E	BIO301-76e00	BIOLOGY LAB. 2	1	1Q	YAMADA, Yoko	3	
	SML5230E	BIO302-76e00	BIOLOGY LAB. 3	1	2Q	YAMADA, Yoko	3	
	SML4030E	MLS301-76e00	SEMINAR 1	1	AUT	Supervisor	4	
	SML4040E	MLS302-76e00	SEMINAR 2	1	SPR	Supervisor	4	
	SML4050E	MLS401-76e00	GRADUATION RESEARCH 1	1	AUT	Supervisor	4	
	SML4060E	MLS402-76e00	GRADUATION RESEARCH 2	1	SPR	Supervisor	4	
	Department Specialized Courses	SML6490E	PHY301-76e00	ATOMIC AND MOLECULAR SPECTROSCOPY	2	Not Offered		1~4
SML6500E		CHM302-76e00	INSTRUMENTAL ANALYSIS	2	AUT	THOMAS, Morgan Leslie	1~4	
SML6510E		CHM303-76e00	ORGANIC AND NATURAL PRODUCT CHEMISTRY	2	SPR	USUKI, Toyonobu	1~4	
SML6520E		CHM304-76e00	ENVIRONMENTAL ANALYTICAL CHEMISTRY	2	SPR	DANIELACHE, Sebastian	1~4	
SML6530E		CHM305-76e00	GREEN CHEMISTRY	2	SPR	HORIKOSHI, Satoshi	1~4	
SML6660E		PHY304-76e00	RADIATION PHYSICS AND CHEMISTRY	2	SPR	ODAGIRI, Takeshi	1~4	
SML6550E		CHM306-76e00	CATALYSIS CHEMISTRY	2	AUT	SUZUKI, Noriyuki	1~4	
SML6570E		CHM302-76e00	THEORY-AIDED MOLECULAR DESIGN	2	AUT	NANBU, Shinkoh	1~4	☆
SML6580E		PHY303-76e00	QUANTUM REACTION DYNAMICS	2	AUT	HOSHINO, Masamitsu	1~4	☆
SML6600E		BIO304-76e00	TOPICS OF GREEN SCIENCE 1	2	SPR	YAMADA, Yoko	1~4	
SML6610E		CHM308-76e00	TOPICS OF GREEN SCIENCE 2	2	AUT	THOMAS, Morgan Leslie	1~4	
SML6620E		BIO305-76e00	TOPICS OF GREEN SCIENCE 3	2	AUT	SAITO / YAMADA	1~4	
SML6590E		BIO303-76e00	TOPICS OF PLANT SCIENCE	2	SPR	SUZUKI / FUJIWARA	1~4	
SML6630E		CHM309-76e00	STRUCTURAL CHEMISTRY	2	Not Offered		1~4	☆
SML6700E		CHM310-76e00	SEPARATION CHEMISTRY IN ANALYSIS	2	1Q	HAYASHITA, Takashi	1~4	☆◇
SML6710E		CHM323-76e00	METALLIC AND ELECTRONIC MATERIALS	2	SPR	YOKOTA, Yukie	1~4	
SML6720E		CHM311-76e00	POLYMER CHEMISTRY	2	SPR	FUJITA / TAKEOKA	1~4	
SML6730E	CHM-312-76e00	SYNTHETIC ORGANIC CHEMISTRY	2	AUT	WITULSKI, Bernhard Fritz Josef	1~4	★	
099712	ENV206-02e00	ENVIRONMENTAL SCIENCE	2	1Q / 3Q	SUGIURA, Mikiko	1~4		
099716	CMF203-02e00	SUSTAINABLE DEVELOPMENT	2	1Q / 3Q	SUGIURA, Mikiko	1~4		

☆ = Every Other Year

◇ = This course cannot be registered by students that have already registered in ION EXCHANGE IN ENVIRONMENTAL CHEMISTRY

★ = Course taught by invited professor

Course List

Department of Engineering and Applied Sciences (Green Engineering)

	Course No.	Numbering	Course title	Cr.	Semester offered	Instructor	Student Year	Remarks
Department Core Courses	SEA2040E	MEC101-77e00	ENGINEERING AND APPLIED SCIENCES 1	2	AUT	ZHANG, Yuelin	2	
	SEA2050E	PHY101-77e00	ENGINEERING AND APPLIED SCIENCES 2	2	AUT	ZHANG, Weilu	2	
	SEA2060E	EEE201-77e00	ENGINEERING AND APPLIED SCIENCES 3	2	AUT	LI, Ning	2	
	SEA2070E	EAS101-77e00	ENGINEERING AND APPLIED SCIENCES LAB. 1	1	AUT	SUZUKI / TAKAYANAGI / HISAMORI / KIKUCHI / NAKAMURA / TOGASHI / ZHANG	2	
	SEA2080E	EAS201-77e00	ENGINEERING AND APPLIED SCIENCES LAB. 2	1	SPR	KIKUCHI / SAKAMA / SHIMOMURA / TAKAI / KUWAHARA / GOTO / NAKAMURA / WATANABE / DZIEMINSKA / TAKEHARA / TOGASHI / YILMAZ / SHEN / LI	2	
	SEA5140E	PHY301-77e00	GREEN ENGINEERING LAB. 1	1	AUT	ZHANG, Weilu	3	
	SEA5150E	MEC301-77e00	GREEN ENGINEERING LAB. 2	1	SPR	ICHIYANAGI / CAO / TANAKA / NAGASHIMA / TAKEHARA / HISAMORI	3	
	SEA5160E	EEE301-77e00	GREEN ENGINEERING LAB. 3	1	AUT	SAKAMOTO / TOGASHI / NOMURA / TAKAO / MIYATAKE / LI	4	
	SEA5170E	EAS301-77e00	TOPICS OF GREEN ENGINEERING 1	2	1Q	DZIEMINSKA, Edyta	2	*2
	SEA5180E	EAS302-77e00	TOPICS OF GREEN ENGINEERING 2	2	AUT	AOKI, Yuichiro*	3	
	SEA4030E	EAS401-77e00	GRADUATION RESEARCH 1	1	AUT	Supervisor	4	
	SEA4040E	EAS402-77e00	GRADUATION RESEARCH 2	1	SPR	Supervisor	4	
Department Specialized Courses	SEA6520E	MEC302-77e00	THERMAL ENERGY CONVERSION	2	AUT	SUZUKI, Takashi	1~4	
	SEA6530E	MEC303-77e00	FLUID ENERGY CONVERSION	2	SPR	WATANABE, Mariko	1~4	
	SEA6540E	MEC304-77e00	ENERGY & MATERIALS	2	AUT	TAKAI, Kenichi	1~4	
	SEA6550E	EEE302-77e00	NUCLEAR ENERGY ENGINEERING	2	AUT	LIEM PENG HONG* / SHINOHARA* / YOSHIKAWA* / IKUTA* / MIYATAKE / YAGAI / SAKAMOTO / HIRADE*	1~4	Every Other Week
	SEA6690E	EEE306-77e00	MOTOR DRIVE SYSTEMS	2	Not offered		1~4	☆, *1
	SEA6590E	EEE305-77e00	CLEAN ENERGY	2	SPR	YAGAI, Tsuyoshi	1~4	
	SEA6600E	EAS303-77e00	SIMULATION ENGINEERING	2	Not offered		1~4	☆
	SEA6610E	INF308-77e00	COMMUNICATION AND NETWORK ENGINEERING	2	SPR	BANDAI / OGAWA / HAYASHI / TAKAHASHI	1~4	
	SEA6620E	EAS403-77e00	TOPICS OF GREEN ENGINEERING 3	2	SPR	LI, Ning	1~4	
	SEA6650E	EAS404-77e00	AIRCRAFT DESIGN WITH MECHANICS OF FLIGHT	2	1Q	DZIEMINSKA, Edyta	1~4	
	SEA6660E	EEE307-77e00	PHYSICS AND ENGINEERING OF ELECTRONIC DEVICES	2	AUT	LI, Ning	1~4	
	SEA6585E	EEE304-77e00	POWER ELECTRONICS	2	SPR	MIYATAKE, Masafumi	1~4	☆
	SEA6580E	EEE303-77e00	ELECTRIC POWER SYSTEM ENGINEERING	2	AUT	SAKAMOTO, Orie	1~4	
	SEA6680E	PHY302-77e00	OPTICS	2	SPR	ZHANG, Weilu	1~4	
	099712	ENV206-02e00	ENVIRONMENTAL SCIENCE	2	1Q / 3Q	SUGIURA, Mikiko	1~4	
099716	CMF203-02e00	SUSTAINABLE DEVELOPMENT	2	1Q / 3Q	SUGIURA, Mikiko	1~4		

[]=Lottery Courses. Number in brackets is the capacity.

Instructor's name with * = adjunct instructor

☆=Every Other Year

*1: The students who has taken "Electrical Drives and Controls" cannot take this course.

*2: In AY2022 Spring semester, the course is offered in 1Q for 2nd year students. It will not be offered in AY2022 Autumn and AY2023 Spring semesters.

* Although the language of instruction for the following courses are different, courses listed here are regarded as identical courses.

The students may only take one of the two courses.

English			Japanese	
Course No.	Course Title		Course No.	Course Title
SCT6740E	THERMODYNAMICS	⇔	SCT68300	熱力学
SCT6760E	INTRODUCTION TO QUANTUM DYNAMICS	⇔	SCT68900	量子力学入門
SCT6770E	ATOMIC & MOLECULAR SCIENCES	⇔	SCT64800	原子・分子科学
SCT6680E	LIFE CYCLE ASSESSMENT	⇔	SEA67050	ライフサイクルアセスメント
SCT6650E	MOLECULAR BIOLOGY	⇔	SCT66800	分子生物学
SCT6750E	CELL BIOLOGY	⇔	SCT62300	細胞生物学
SCT6800E	ORGANIC CHEMISTRY	⇔	SCT60600	有機化学 (有機分子)
SCT6865E	ELECTRIC CIRCUITS	⇔	SCT68600	電気回路II
SML6510E	ORGANIC AND NATURAL PRODUCT CHEMISTRY	⇔	SML61500	天然有機化学
SML6530E	GREEN CHEMISTRY	⇔	SML61700	グリーンケミストリー
SML6660E	RADIATION PHYSICS AND CHEMISTRY	⇔	SML62500	放射線科学
SML6550E	CATALYSIS CHEMISTRY	⇔	SML65300	触媒反応化学
SML6570E	THEORY-AIDED MOLECULAR DESIGN	⇔	SML64200	理論分子設計
SML6580E	QUANTUM REACTION DYNAMICS	⇔	SML65100	原子衝突物理学
SML6590E	TOPICS OF PLANT SCIENCE	⇔	SML65200	植物生理学
SML6630E	STRUCTURAL CHEMISTRY	⇔	SML60100	分子構造化学
SML6640E	ION EXCHANGE IN ENVIRONMENTAL CHEMISTRY	⇔	SML60400	分離分析化学
SML6700E	SEPARATION CHEMISTRY IN ANALYSIS	⇔	SML60400	分離分析化学
SEA2040E	ENGINEERING AND APPLIED SCIENCES 1	⇔	SEA10200	機能創造理工学 1
SEA2050E	ENGINEERING AND APPLIED SCIENCES 2	⇔	SEA10300	機能創造理工学 2
SEA2060E	ENGINEERING AND APPLIED SCIENCES 3	⇔	SEA20400	機能創造理工学 3
SEA6520E	THERMAL ENERGY CONVERSION	⇔	SEA60400	熱エネルギー変換
SEA6530E	FLUID ENERGY CONVERSION	⇔	SEA60500	流体エネルギー変換
SEA6540E	ENERGY & MATERIALS	⇔	SEA61800	エネルギーと材料
SEA6690E	MOTOR DRIVE SYSTEMS	⇔	SEA67600	モータドライブシステム I
		⇔	SEA67700	モータドライブシステム II
SEA6580E	ELECTRIC POWER SYSTEM ENGINEERING	⇔	SEA65600	電力系統工学
SEA6610E	COMMUNICATION AND NETWORK ENGINEERING	⇔	SIC61700	通信ネットワークシステム
SEA6590E	CLEAN ENERGY	⇔	SEA65700	電気機器学
SEA6585E	POWER ELECTRONICS	⇔	SEA65800	パワーエレクトロニクス
SML6710E	METALLIC AND ELECTRONIC MATERIALS	⇔	SML65800	金属・電子材料
SML6720E	POLYMER CHEMISTRY	⇔	SML62800	高分子化学
SML6720E	POLYMER CHEMISTRY	⇔	SML62900	ソフトマテリアル
SML6620E	TOPICS OF GREEN SCIENCE 3	⇔	SML64500	細胞機能工学
SCT6820E	ATMOSPHERIC CHEMISTRY	⇔	SML65600	大気化学

Sophia Program for Sustainable Futures (SPSF) Curriculum

For all SPSF Students	… P. 104
General Studies	… P. 106
Language	… P. 115
Department of Journalism	… P. 124
Department of Education	… P. 132
Department of Sociology	… P. 142
Department of Economics	… P. 152
Department of Management	… P. 163
Department of Global Studies	… P. 172
All SPSF Course List	… P. 184

For all SPSF students

Sophia Program for Sustainable Futures (SPSF) Organization

SPSF consists of the following six departments of social sciences:

Department of Journalism; Department of Education; Department of Sociology;

Department of Economics; Department of Management; and Department of Global Studies

1. SPSF Common Core courses

SPSF students take SPSF Common Core courses. The SPSF Common Core courses are structured into “Theme-based” and “Academic Skills” courses, which are required to be taken by first-and third-year students.

Theme-based courses: Two required courses for the first-and third-year students which cover interrelationships between the discipline the student majors in and the concept of sustainability. The first year’s course focuses on the connections among them, and the third year’s course provides more practical opportunities. These are mandatory courses for all SPSF students in order to meet graduation requirements. No transfer credits are allowed to the two required courses “First Year Lecture in/about Sustainable Futures” and “Third Year Seminar for Sustainable Futures”. For more details, refer to the curriculum pages of General Studies Courses.

Academic Skills courses: First-year students are required to take four courses offered by the Center for Language Education and Research (CLER) to equip themselves with skills necessary for their learning at Sophia University. For more details, refer to the curriculum pages of Language Courses.

In addition to these SPSF Common Courses, the students also take classes relating to their major as well as other classes offered by other SPSF departments.

2. Specialized Education

SPSF students are required to take Specialized Education courses, which are mainly provided by the department the student belongs to. For more details, refer to the curriculum section of each department.

3. When Choosing Courses for Fulfilling SPSF Graduation Requirements

SPSF students must meet their graduation requirements mainly with credits received from SPSF courses taught in English (refer to Distribution of Required Credits).

However, students may include up to 24 credits earned from courses taught in Japanese in their graduation requirements. For more details on each department’s Distribution of Required Credits and Guidelines for Course Registration, refer to the curriculum section of each department. Should you take courses taught in Japanese, see the following instructions 4. and 5. carefully.

4. 24 Credit Limit of Courses Taught in Japanese

The courses include

1) All courses except those offered by CLER:

The instruction language shown in the course numbering should be either “j” or “m”: “j” for classes in Japanese and “m” for the others.

With reference to each course numbering, check the course list in each department which offers the course(s) taught in Japanese on the Academic Handbook (履修要覧 [学部科目編]).

For details of the course numbering, refer to the page on p.24.

2) Courses offered by CLER:

Language courses except for Japanese, Chinese, French and Spanish

Note:

- Notify the Center for Academic Affairs after you took a course with the instruction language “m” but Japanese was not used at all.
- Those who wish to take more than 24 credits of courses taught in Japanese should also report to the Center for Academic Affairs, with an understanding that those exceeding courses will not count toward the graduation requirements.

5. Guidelines for the Level of Taking Courses Taught in Japanese

To register for courses offered in Japanese, a student who is a native speaker of Japanese should have attended more than 10 years of education in which Japanese was the primary language of instruction, or have demonstrated sufficient proficiency in Japanese by being placed in a class with a level higher than JPN343 as a result of taking the Japanese Placement Test administered by the university, or by passing JPN343 (Reading and Writing 3). A non-native speaker of Japanese should have demonstrated sufficient proficiency in Japanese by being placed in a class with a level higher than JPN322 as a result of taking the Japanese Placement Test, or by passing either JPN322 (Advanced Japanese 2) or JPN370 (Intensive Japanese 4).

Students are strongly advised to observe the criteria for Japanese language proficiency in taking courses conducted in Japanese. Students will be responsible for their own academic performance, including any difficulty resulting from issues related to Japanese language proficiency.

6. Limit on the Number of Credits per Semester for all SPSF students

SPSF students can take up to 24 credits in each semester. The following limitations apply to the maximum number of credits that can be registered in each academic semester.

First Year		Second Year		Third Year		Fourth Year		Total
Autumn	Spring	Autumn	Spring	Autumn	Spring	Autumn	Spring	
24	24	24	24	24	24	24	24	192

7. SPSF Early Graduation System

SPSF students can apply for early graduation if they wish to graduate (in six or seven semesters), provided certain requirements are met. The following departments offer the opportunity for early graduation: Department of Education; Department of Sociology; Department of Economics; Department of Management; and Department of Global Studies. For more details on the requirements for early graduation, refer to the curriculum section of each department.

8. Change of Faculty / Department

No change of Faculty / Department within the SPSF Departments is accepted for the time being. For further details, see the page of Academic Records.

GENERAL STUDIES

【Students who entered in 2022】

At Sophia University, University-wide General Studies are designed for students to acquire the abilities necessary for various studies. In addition to learning the spirit of “Christian Humanism” that underlies all Sophia University education, students will cultivate the ability to identify issues, formulate questions, and solve problems from multiple perspectives with a wide range of knowledge. The purpose is to create a foundation for students to continue learning throughout their lives and to contribute to the realization of a better world as people who live “for others, with others.”

University-wide General Studies courses are structured into categories by topics and in multiple levels. The students are expected to take these courses throughout their undergraduate studies in order to expand the depth and the width of their learning.

Compulsory Courses

All the compulsory courses are divided into designated timetables (blocks) for each department. The class and the registration code will be posted on the Loyola Bulletin Board. Check the Board and register by yourself during the registration period. The following five courses are the compulsory General Studies courses.

Studies in Christian Humanism: For Others, With Others Liberal Arts of the Body

Both “Studies in Christian Humanism: For Others, With Others” and “Liberal Arts of the Body” are Quarter courses, and students must take them in designated blocks. Students must check their designated blocks on Loyola Bulletin Board.

Semester Offered	Day & Time
Autumn	Thu, 3

***Liberal Arts of the Body Special Class**

This class is offered on Tuesdays second period in third quarter for students who have difficulty taking the designated “Liberal Arts of the Body” class due to health or other reasons.

Students who wish to take this course should contact the Center for Liberal Education and Learning (Embodied Wisdom Area) before the class begins.

Critical Thinking & Discussion

“Critical Thinking & Discussion” is a semester course. Students must take the course in the designated block.

Semester Offered	Day & Time
Spring	Tue, 4 Fri, 4

Overview of Data Science

“Overview of Data Science” is a semester course. Students must take the course in the designated block.

Semester Offered	Day & Time
Spring	Tue, 5

Thinking about Issues, Perspectives, and Positionality

“Thinking about Issues, Perspectives, and Positionality” is a semester course. Students must take the course in the designated block.

“Thinking about Issues, Perspectives, and Positionality” is an *asynchronous course. The course materials will be uploaded on Moodle every Saturday. Students must enroll themselves in “Issues, Perspectives, and Positionality” on Moodle.

*Asynchronous classes: Classes are delivered in video lectures, slides, or other asynchronous formats.

Semester Offered	Day & Time
Autumn	Sat, 6

***Students who fail to complete the Compulsory Course in the first year**

Students who fail to complete the Compulsory Courses in the first year must take them in the second year or later. The procedure of taking compulsory courses will be announced in the next year’s Bulletin of Information.

Compulsory Elective Courses

Studies in Christian Humanism

Studies in Christian Humanism (Compulsory Elective Courses) must be taken in their third semester.

Course List

Registration CD	Semester offered	Course title	Cr.	Day & Time
GSCH0130	Autumn	STUDIES IN CHRISTIAN HUMANISM: PHILOSOPHY OF RELIGIOUS LANGUAGE	2	Tue, 5
GSCH0051	Autumn	STUDIES IN CHRISTIAN HUMANISM: THE LIGHT OF CHRISTIAN INTRODUCTION TO CATHOLICISM	2	Tue, 5

Please note that places in these courses will be chosen by lottery, so students should register for these courses during the **lottery registration period**. For details, See p.28~.

Advanced General Education Courses

Students must take 4 credits of Advanced General Education Courses including SPSF Common Core (Theme-based) “Third Year Seminar for Sustainable Futures (2cr)”. For the remaining 2 credits, students must choose from the Advanced General Education courses listed in the University-wide General Studies courses in your junior / senior years. (cf.履修要覧)

Notes on Advanced General Education Courses for SPSF Students

All Students must take at least 2 credits of “Advanced General Education Course” as a part of GS Compulsory Electives.

- Students may take the Advanced General Education Course from the fifth semester (ie. their first semester in the junior year).
- If students take more than 2 credits of Advanced General Education Courses, he/she can count these credits as GS Electives courses.
- Most of the Advanced General Education Courses are lottery courses. Students must enter during the lottery entry period.
- For lottery courses of “Advanced General Education Course”, students will not get accepted into more than one course per semester.

【Students who entered before 2022】

Health and Physical Education

Students who have not earned credits for “Wellness, the Body and Culture” must take “Wellness, the Body and Culture” (*Asynchronous course). All courses are lottery courses, so students should register for these courses during the **lottery registration period**. For details, See p.28～.

*Asynchronous classes: Classes that deliver video, Power Point, and other teaching material files.

Semester, Day, Time

Autumn semester Saturday, 6th period

Spring semester: Saturday, 6th period

Students who entered before 2022 may take any of the following semesters.

Studies in Christian Humanism

Two courses in the category “Studies in Christian Humanism” (キリスト教人間学) for a total of 4 credits are compulsory for all students who are enrolled in the SPSF. Normally, students must take one course in their first semester and another in the second semester.

Course List

Registration CD	Semester offered	Course title	Cr.	Day & Time
GSCH0130	Autumn	STUDIES IN CHRISTIAN HUMANISM: PHILOSOPHY OF RELIGIOUS LANGUAGE	2	Tue, 5
GSCH0051	Autumn	STUDIES IN CHRISTIAN HUMANISM: THE LIGHT OF CHRISTIAN INTRODUCTION TO CATHOLICISM	2	Tue, 5

Please note that places in these courses will be chosen by lottery, so students should register for these courses during the **lottery registration period**. For details, See p.28～.

Advanced General Education Courses

Students must take SPSF Common Core (Theme-based) “Third Year Seminar for Sustainable Futures (2cr)” as “Advanced General Education Course”.

【All Students】

General Studies SPSF Common Core (Themed Based)

All SPSF students must take two courses in the category SPSF Common Core (Theme-based), “First Year Lecture in/about Sustainable Futures(4 cr)” and “Third Year Seminar for Sustainable Futures(2cr)”.

The first year theme-based course “First Year Lecture in/about Sustainable Futures” will be given in a lecture format by professors from the six departments in the first semester. Students will see how the topics relating to their own disciplines inter-connect with each other when put together around the theme of “sustainability.”

In their fifth semester of the third year, after they acquired knowledge through courses of their own major and other majors, they take another theme-based course, “Third Year Seminar for Sustainable Futures,” where students will bring in knowledge and perspectives they obtained in their own major and share them with students of other majors.

Please note that the course “Third Year Seminar for Sustainable Futures” is offered to SPSF students as “Advanced General Education Course” which is a part of general requirements for all undergraduate students at Sophia University.

Course List

Registration CD	Semester offered	Course title	Cr.	Day & Time
GSSS1010	Autumn	FIRST YEAR LECTURE IN/ABOUT SUSTAINABLE FUTURES	4	Tue, 2-3
GSSS3010	Autumn	THIRD YEAR SEMINAR FOR SUSTAINABLE FUTURES	2	Thu, 4

【All Students】

General Studies Elective Courses

All SPSF students must take 12 credits of courses(*14 credits for the students who entered before 2022) listed in the University-wide General Studies course as Zengaku kyotsu kamoku (全学共通科目) conducted in Courses taught in English as GS Electives.

Students who wish to take GS Elective courses offered in Japanese* shown in the course numbering should be “j”, consult the Center for Academic Affairs during the registration period.

Note: GS Elective courses taught in Japanese cannot be counted as GS Elective requirements.

Note that only up to 8 credits are approved for courses from Language Programs.(※)

※No more than 24 credits of Courses taught in Japanese in total.

For details regarding Language courses, see p.117, “LANGUAGES (OTHER THAN ENGLISH)”

First-year Students may take up to 4 credits of General Studies Elective Courses each semester.

Course List

- Remarks: [] =Lottery Courses. Number in brackets is the capacity.

Registration CD	Semester offered	Course title	Cr.	Day	Time	Remarks
GSP20890	Autumn	THE HISTORIOGRAPHY OF AFRICA	2	Fri	1	
GSP20920	Autumn	AFRICAN CULTURE	2	Wed	1	
GSS20380	Autumn	AFRICAN RELIGION: AFRICAN TRADITIONAL BELIEFS AND RITES FROM ANCIENT EGYPT TO THE PRESENT	2	Mon	1	
GSS20401	Spring	CULTURAL REVITALIZATION AND COMMUNITY BUILDING	2	Wed	3	[50]
GSB20030	Spring	EXPERIENCING THE MIRACLE OF LIFE	2	Fri	3	[100]
GSC20040	Spring	‘GOD, MAN AND THE WORLD’: INTERDISCIPLINARY PERSPECTIVES ON SUSTAINABLE DEVELOPMENT	2	Wed	3	
GSS20340	Spring	INTERNATIONAL POLITICS AND PEACEBUILDING 1	2	Fri	3	[50]
GSS20360	Spring	INTRODUCTION TO CONFLICTS AND HUMAN SECURITY	2	Tue	2	[130]
GSS20430	Spring	DIVERSITY & INCLUSION: IDEAS TO BRING ABOUT EMPOWERING AND THRIVING SOCIETIES	2	Mon	4	[120]
GSP20750	Spring	INTRODUCTION TO INTERNATIONAL COOPERATION THEORY AND PRACTICE	2	Thu	5	[110]
GSP20970	Spring	INTRODUCTION TO INTERNATIONAL COOPERATION -OVERVIEW AND MANAGEMENT METHOD OF JAPAN’S INTERNATIONAL COOPERATION -	2	Wed	4	[140]
GSS20400	Autumn	CULTURAL REVITALIZATION AND COMMUNITY BUILDING	2	Wed	2	[50]
GSP20450	Autumn	COMPARATIVE CULTURAL STUDIES (DISCOVERING RUSSIAN CULTURE)	2	Mon	5	[150]
GSP20480	Autumn	MODERN CHEMISTRY IN LIFE AND SOCIETY	2	Fri	1	
GSS20160	Autumn	JAPANESE POP CULTURE	2	Wed	3	[55]
GSB20031	Autumn	EXPERIENCING THE MIRACLE OF LIFE	2	Fri	3	[100]
GSS20320	Autumn	GLOBALIZATION AND ORGANIZATIONS	2	Tue	2	[40]
GSS20620	Autumn	HOW CHANGE HAPPENS: LEADERSHIP THAT HARNESSES AND ADVANCES DIVERSITY & INCLUSION	2	Mon	6	[25]
GSP20390	Autumn	INTRODUCTION TO ENGLISH LINGUISTICS	2	Fri	4	[100]
GSS20130	Autumn	MIXED ROOTS IDENTITY AND TRANSNATIONAL IDENTITY	2	Wed	2	[100]
GSS20200	Autumn	HUMAN BEHAVIOUR AND SOCIAL ENVIRONMENT	2	Mon	5	[100]

GSS20310	Autumn	APPROACHES TO INTERCULTURAL COMPETENCE	2	Tue	2	
GSS20610	3Q	GENDER EQUALITY, INTERNATIONAL COOPERATION, UN, GLOBAL COMMUNITIES AND JAPAN	2	Tue, Fri	6	[20]
GSS20540	4Q	REIMAGINING EDUCATION TOWARDS SUSTAINABLE FUTURES	2	Tue, Fri	3	
GSS20530	4Q	FUTURE ORIENTED SYSTEMS THINKING FOR SUSTAINABILITY IN TURBULENT TIMES	2	-	-	Intensive Course
GSS20660	Spring	DEBATE ON PEACEBUILDING	2	Wed	4	[60]
GSP20300	Not Offered	INTRODUCTION TO WORLD ECONOMIC HISTORY	2			
GST20140	Not Offered	PRACTICAL ENGLISH WRITING	2			[30]
GSP20630	Not Offered	INTRODUCTION TO PSYCHOLOGY	2			[100]

Please note that places in these courses will be chosen by lottery, so students should register for these courses during the **lottery registration period**. For details, See p.28~.

■SAIMS Program Courses

☆ The Sophia AIMS Program (SAIMS) is a trans-disciplinary program focusing on “Human Development”, and its main theme is “Human Ecology: Diversity and Connectivity of Society and Nature”. Students from ASEAN countries and Japan will study together in a program that combines the disciplinary frameworks of natural sciences, social sciences, and humanities. All courses are conducted in English (TOEFL iBT79 or its equivalent level is required.)

The SAIMS program participants are strongly recommended to take at least one of these courses before or after studying abroad under the SAIMS program.

Course List

- Remarks: [] = Lottery Courses. Number in brackets is the capacity.

Registration CD	Semester offered	Course title	Cr.	Day	Time	Remarks
GSS20520	1Q	SUSTAINABLE DEVELOPMENT	2	Tue, Fri	3	[100]
GSS20510	1Q	ENVIRONMENTAL SCIENCE	2	Mon, Thu	3	[100]
GSS20500	2Q	CONSERVATION	2	Tue, Fri	3	[100]
GSS20521	3Q	SUSTAINABLE DEVELOPMENT	2	Tue, Fri	3	[100]
GSS20511	3Q	ENVIRONMENTAL SCIENCE	2	Mon, Thu	3	[100]
GSS20501	4Q	CONSERVATION	2	Tue, Fri	3	[100]

[] = Lottery Courses. Number in brackets is the capacity.

※: Faculty of Economics-SPSF students can include these courses into their Departmental Specialized Education.

For details, please refer to p.157

■Overseas Active learning Program, Internship Course

*Overseas Active Learning Program and Internship courses in which the language of instruction is more than one language (numbered with an “m”) are also be countable as GS electives toward graduation requirements.

Course List

- Remarks: [] = Lottery Courses. Number in brackets is the capacity.

Registration CD	Semester offered	Course title	Cr.	Day	Time	Remarks	Language of Instruction
GSEN2390	Spring	STUDY VISIT TO THE INTERNATIONAL ORGANIZATIONS IN GENEVA	2	-	-	Intensive Course	m
GSEN2400	Spring	GLOBAL INTERNSHIPS (MEDIUM-TERM)	6	-	-	Intensive Course	m
GSEN2020	Spring	GLP GLOBAL LEADERSHIP PROGRAM	2	-	-	Intensive Course	m
GSEN2090	Spring	AJCU-AP SERVICE LEARNING PROGRAM	4	-	-	Intensive Course	m
GSEN2170	Spring	GLOBAL INTERNSHIPS (SHORT-TERM)	2	-	-	Intensive Course	m
GSEN2350	Spring	ESTONIA STUDY TOUR FOR SUSTAINABLE DEVELOPMENT AND EDUCATION	2	-	-	Intensive Course	m
GSEN2360	Spring	SOCIO-ECONOMIC AND HUMAN DEVELOPMENT STUDY OF INDIA: CASE STUDY OF KERALA MODEL	2	-	-	Intensive Course	m
GSEN2370	Spring	PRACTICAL INTENSIVE COURSE ON INTERNATIONAL CIVIL SERVICE AT UNITED NATIONS HEADQUARTERS, NEW YORK	2	-	-	Intensive Course	m
GSEN2480	Spring	INTRO. TO THE HISTORY & CONTEMPORARY SOCIETY OF AFRICA A	2	-	-	Intensive Course	m
GSEN2520	Spring	UD TRUCKS INTERNSHIP PROGRAM-A DOOR TO A WORLD LEADER IN SUSTAINABLE TRANSPORT SOLUTIONS	2	-	-	Intensive Course	m
GSEN2050	Autumn	UNITED NATIONS: ROLE & FUNCTIONS (INTENSIVE COURSE AT THE UN HEADQUARTERS IN N.Y)	2	-	-	Intensive Course	m
GSEN2070	Autumn	SERVICE LEARNING PROGRAM IN INDIA	4	-	-	Intensive Course	m
GSEN2171	Autumn	GLOBAL INTERNSHIPS (SHORT-TERM)	2	-	-	Intensive Course	m
GSEN2450	Autumn	MYANMAR STUDY TOUR	2	-	-	Intensive Course	m
GSEN2490	Autumn	INTRO. TO THE HISTORY & CONTEMPORARY SOCIETY OF AFRICA B	2	-	-	Intensive Course	m
GSEN2410	Autumn	LEARNING FROM THE INSIDERS: A FIELD STUDY COURSE ON THE SUSTAINABILITY OF RURAL SOCIETY	2	Wed	1	[20]	e
GSEN2460	Autumn	LEADERSHIP FOR A MULTICULTURAL SOCIETY	2	-	-	Intensive Course	m
GSEN2470	Autumn	SERNCE LEARNING PROGRAM IN INDIA	2	-	-	Intensive Course	m
GSEN2521	Not Offered	UD TRUCKS INTERNSHIP PROGRAM-A DOOR TO A WORLD LEADER IN SUSTAINABLE TRANSPORT SOLUTIONS	2	-	-	Intensive Course	m

[]=Lottery Courses. Number in brackets is the capacity.

■Summer Session in East Asian Studies and Japanese Language

Students may take Summer Session in East Asian Studies and Japanese Language courses offered by the Center for Global Education and Discovery. Summer Session courses are not counted into maximum credit limits per semester or year. More information on registration procedures and programs will be posted on the Loyola Bulletin Board (Academic Services) in April 2022.

【All Students】

Advanced General Education Courses

<Students who entered in 2022>

SPSF students who entered in 2022 must take 2 credits of courses listed in the Advanced General Education Courses taught in English as GS Compulsory Electives from their fifth period.

※No more than 24 credits of Courses taught in Japanese in total.

<Students who entered before 2022>

SPSF students who entered before 2022 can take courses listed in the Advanced General Education Courses taught in English as GS Electives from their fifth period.

Students who wish to take Advanced General Education courses offered in Japanese* shown in the course numbering should be “j”, consult the Center for Academic Affairs during the registration period.

Note: Advanced General Education courses taught in Japanese cannot be counted as GS Compulsory Elective / GS Elective requirements.

Course List

- Remarks: [] = Lottery Courses. Number in brackets is the capacity.

Registration CD	Semester offered	Course title	Cr.	Day	Time	Remarks
GSP30110	Spring	KEY GLOBAL ECONOMIES	2	Wed	4	[100]
GSC30110	Spring	CATHOLIC SOCIAL THOUGHT AND THE CATHOLIC CHURCH TODAY	2	Tue	3	[70]
GSP30070	Autumn	JAPANESE AMERICAN HISTORY	2	Thu	2	[100]
GSS30220	Autumn	FOREIGN AND SECURITY POLICY OF JAPAN	2	Mon	3	[100]
GSS30090	Autumn	HOSPITALITY BUSINESS IN ASIA	2	-	-	Intensive Course
GSS30100	Autumn	GENERAL MANAGEMENT IN ACTION	2	-	-	Intensive Course
GSC30111	Autumn	CATHOLIC SOCIAL THOUGHT AND THE CATHOLIC CHURCH TODAY	2	Tue	3	[70]
GSP30060	Not Offered	UNDERSTANDING PICTUREBOOKS	2			[100]

Please note that places in these courses will be chosen by lottery, so students should register for these courses during the **lottery registration period**. For details, See p.28~.

■Overseas Active learning Program, Internship Course

*Overseas Active Learning Program and Internship courses in which the language of instruction is more than one language (numbered with an “m”) are also be countable as GS electives toward graduation requirements.

Course List

- Remarks: [] = Lottery Courses. Number in brackets is the capacity.

Registration CD	Semester offered	Course title	Cr.	Day	Time	Remarks	Language of Instruction
GSEN3151	Spring	GLOBAL INTERNSHIPS (LONG-TERM)	6	-	-	Intensive Course	m
GSEN3180	Spring	GLOBAL INTERNSHIPS FOR SENIOR/JUNIOR (SHORT-TERM)	2	-	-	Intensive Course	m
GSEN3440	Spring	GLOBAL INTERNSHIPS FOR SENIOR/JUNIOR (MEDIUM-TERM)	6	-	-	Intensive Course	m
GSEN3530	Spring	UD TRUCKS INTERNSHIP PROGRAM-A DOOR TO A WORLD LEADER IN SUSTAINABLE TRASPOT SOLUTIONS (SENIOR/JUNIOR)	2	-	-	Intensive Course	m
GSEN3150	Autumn	GLOBAL INTERNSHIPS (LONG-TERM)	6	-	-	Intensive Course	m
GSEN3181	Autumn	GLOBAL INTERNSHIPS FOR SENIOR/JUNIOR (SHORT-TERM)	2	-	-	Intensive Course	m
GSEN3531	Not Offered	UD TRUCKS INTERNSHIP PROGRAM-A DOOR TO A WORLD LEADER IN SUSTAINABLE TRASPOT SOLUTIONS (SENIOR/JUNIOR)	2	-	-	Intensive Course	m

LANGUAGE

LANGUAGE (SPSF COMMON CORE-ACADEMIC SKILLS)

SPSF Common Core-Academic Skills consists of four courses: Academic Writing 1, Academic Writing 2, Academic Presentations and Critical Thinking and Discussion. These are offered by the Center for Language Education and Research (CLER) located on the 5th Floor in Building 6. All SPSF students are required to take these courses.

● COURSE DESCRIPTIONS

ACADEMIC WRITING 1 (AW1)

In this course, students will develop their academic writing skills using a four skills integrated approach to well-equip them to write essays and research papers for undergraduate classes in English. The course will take a task-based, learning through doing approach to writing, starting from finding and evaluating academic sources and developing research questions, through to editing and discussing written work in seminar-style classes. Students will write about topics related to modern society in Japan which interest them. Classes will consist of input on academic writing skills from the teacher, in-class writing exercises and practice, teacher and peer feedback on students' written work, and presentation and discussion of students' assignments.

ACADEMIC WRITING 2 (AW2)

This course will build on and further develop the academic writing skills learned in Academic Writing 1. Students will undertake a research project involving some original research which culminates in a research paper. This project will also require students to draw from more academic sources and have a focus on critique as well as summary or description. They will also have greater freedom to choose topics related to their own studies or interests.

ACADEMIC PRESENTATIONS

In this course, students will build their confidence in speaking in front of others and develop key presentation skills. Students will begin to develop their skills by making presentations on their own personal and academic interests. As the semester progresses, students will develop more advanced academic presentation skills by giving poster presentations, and by giving presentations at a mock academic conference on the theme of Japanese society, for which students can utilize their research from Academic Writing 1. As well as input from the teacher there will be extensive practice of presentation skills and active observation of other students' presentations.

CRITICAL THINKING & DISCUSSION

In this course, students will develop the critical thinking skills they need to perform well academically as undergraduates and beyond. They will learn key terms and concepts in critical thinking and practice applying those by closely examining a variety of texts on which they will write short summaries or reactions. Through this process, students will also reflect on their own thinking processes and skills. Most in-class work will be based around discussions of the various texts and topics, with input and guidance from the teacher on academic discussion skills. Students will also learn how to demonstrate their critical thinking skills in these discussions.

● REGISTRATION RULES

ACADEMIC WRITING 1 (AW1) / ACADEMIC WRITING 2 (AW2)

- ACADEMIC WRITING must be taken in the following sequence:

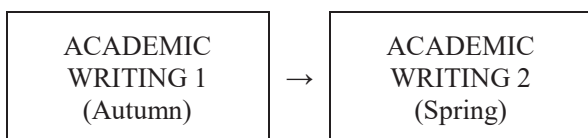

- * Students cannot register for the next course if they have not completed the previous course. (If students have not completed AW1, they cannot register for AW2. If they are not able to fulfill the course requirements, they will re-register for AW1 in the following Autumn semester.)
- * Students cannot register for the same course which they have already completed.
- Students must take all courses and gain 4 credits. (2 credits / course)
- ACADEMIC WRITING is counted as a SPSF Common Core (Academic Skills) course.
- No withdrawals are allowed for these courses.
- Students should register for these courses during the registration period. Students are required to take designated classes.

ACADEMIC PRESENTATIONS (Autumn)

- ACADEMIC PRESENTATIONS is counted as a SPSF Common Core (Academic Skills) course.
- No withdrawals are allowed for these courses.
- Students should register for these courses during the registration period. Students are required to take designated classes.
- Students can register for ACADEMIC PRESENTATIONS and CRITICAL THINKING & DISCUSSION in the order that they wish.

CRITICAL THINKING & DISCUSSION (Spring)

- CRITICAL THINKING & DISCUSSION is counted as a SPSF Common Core (Academic Skills) course for the students who entered in and before 2021.
- For the students who entered in and after 2022, CRITICAL THINKING & DISCUSSION is counted as a GS Compulsory Course (The Art of Thinking and Express).
- No withdrawals are allowed for these courses.
- Students should register for these courses during the registration period. Students are required to take designated classes.
- Students can register for ACADEMIC PRESENTATIONS and CRITICAL THINKING & DISCUSSION in the order that they wish.

As for the attendance rules, see ATTENDANCE POLICY FOR LANGUAGE COURSES on p.120.

For any detail of designated classes, please check Loyola Bulletin Board (Language courses • LLC), at the beginning of each semester. The announcement will be done by April 7th (Thu) in the Spring semester and by September 22nd (Thu) in the Autumn semester. This is also the case with repeaters (i.e. those students who have been absent from any semester and have studied abroad).

LANGUAGES (OTHER THAN ENGLISH)

● **FOREIGN LANGUAGES**

Language courses are offered by the Center for Language Education and Research (CLER) located on the 5th Floor in Building 6. English being the medium of instruction for SPSF students, students are reminded that English does not fall into the category of foreign languages.

Within SPSF, there are different rules and registration procedures for foreign languages between Department of Journalism and others. Also, the SPSF students are strongly encouraged to take Language Courses counted as “Courses taught in English” such as Chinese, French, Spanish or Japanese by the CLER. Students should check carefully the contents written in parentheses in the texts below in bold.

● **(A NOTE TO JOURNALISM STUDENTS ONLY)**

LANGUAGE REQUIREMENT FOR GRADUATION

First of all, Journalism students must choose a language in order to fulfill the language requirement of Specialized Education (SE), Compulsory Elective courses. Students must earn 8 credits in ONE language selected from the Language Courses counted as “Courses taught in English” such as Chinese, French, Spanish or Japanese by the CLER.

When students have chosen the language to fulfill their language requirement, they will need to register the language on Loyola. Please refer to pages on the “Registration for fulfilling language requirements” in “Course Registration Quick Navi for 2022”.

If the language students selected is a lottery course, students will be able to apply for lottery entry after completing the “Registration for fulfilling language requirements”. To take lottery courses, students must apply for the courses during the Lottery entry of each semester.

In principle, no withdrawals are allowed for language courses taken to fulfill the 8-credit language requirement. Once students withdraw from such a class, they will not be allowed to choose that language to fulfill the language requirement. Withdrawal is allowed for language taken under the category of GS or SE Electives.

Students taking Chinese, French or Spanish starting at a higher level may take advanced level courses repeatedly to fulfill the 8-credit language requirement, as long as the advanced level courses are taught by different teachers. However, 2 credit advanced courses (Advanced [Integrated Skills] A to D) cannot be taken more than once.

Students who choose a language they have studied previously and placed at an advanced level may encounter difficulties in completing the required 8 credits in one language.

For students wishing to take language courses exceeding the 8 credits required in the category of Specialized Education (SE), Compulsory Elective courses, up to 8 credits from language courses can be included in their graduation requirements as Elective courses that fall under the category of General Studies courses (GS).

Journalism students can also include language courses into their Elective courses in Specialized Education courses (SE). Please check the chart below for details.

Be sure to see the “(For all the SPSF students) Important rules for Language courses”.

Department		Category	Required Credits	Maximum Credits	Language Courses counted as "Courses taught in English"				Language Courses counted as "Courses taught in Japanese"																	
					Chinese	French	Spanish	Japanese	German	Italian	Korean	Russian	Portuguese	Latin	Indonesian	Tamil	Arabic	Thai	Persian	Cambodian	Burmese	Turkish	Vietnamese	Hindi	Swahili	
Journalism	GS	Electives	-	8	○	○	○	○	○	○	○	○	○	○	○	○	○	○	○	○	○	○	○	○	○	○
	SE	Compulsory Electives	8	8	○	○	○	○	○	○	○	○	○	○	○	○	○	○	○	○	○	○	○	○	○	○
		Electives	-	8	○	○	○	○	○	○	○	○	○	○	○	○	○	○	○	○	○	○	○	○	○	○

● (FOR ALL THE SPSF STUDENTS EXCEPT FOR JOURNALISM STUDENTS)
LANGUAGE REQUIREMENT FOR GRADUATION

For students wishing to take Japanese or any other language courses, up to 8 credits from language courses can be included in their graduation requirements as Elective courses in General Studies (GS).

For departments that allow students to include language courses into their Elective courses in Specialized Education (SE), Japanese or other language courses can be also included into their SE up to the number of credits stipulated by the departments. Please check the chart below for details. SPSF Students are recommended to take language courses counted as “Courses taught in English”.

<SPSF Language Courses>

Department	Category		Maximum Credits	Language Courses counted as "Courses taught in English"				Language Courses counted as "Courses taught in Japanese"															
				Chinese	French	Spanish	Japanese	German	Italian	Korean	Russian	Portuguese	Latin	Indonesian	Tagalog	Arabic	Thai	Persian	Cambodian	Burmese	Turkish	Vietnamese	Hindi
Education	GS	Electives	8	○	○	○	○	○	○	○	○	○	○	○	○	○	○	○	○	○	○	○	○
	SE	Electives	8	○	○	○	○	○	○	○	○	○	○	○	○	○	○	○	○	○	○	○	○
Sociology	GS	Electives	8	○	○	○	○	○	○	○	○	○	○	○	○	○	○	○	○	○	○	○	○
	SE	Electives	8	○	○	○	○	-	-	-	-	-	-	-	-	-	-	-	-	-	-	-	-
Economics	GS	Electives	8	○	○	○	○	○	○	○	○	○	○	○	○	○	○	○	○	○	○	○	○
	SE	Electives	4	○	○	○	○	○	○	○	○	○	○	○	○	○	○	○	○	○	○	○	○
Management	GS	Electives	8	○	○	○	○	○	○	○	○	○	○	○	○	○	○	○	○	○	○	○	○
	SE	Electives	4	○	○	○	○	○	○	○	○	○	○	○	○	○	○	○	○	○	○	○	○
Global Studies	GS	Electives	8	○	○	○	○	○	○	○	○	○	○	○	○	○	○	○	○	○	○	○	○
	SE	Electives	26	○	○	○	○	○	○	○	○	○	○	○	○	○	○	○	○	○	○	○	○

● (FOR ALL THE SPSF STUDENTS) IMPORTANT RULES FOR LANGUAGE COURSES

“First foreign language” refers to a language other than English and Japanese that students study at the university for the first time. Thus, when students have either studied or used the particular language prior to the enrollment of the course and their proficiency in the language exceeds the course goals and learning objectives, students will not be able to register for the course. If students register without permission for a course which does not match their ability, the registration will be terminated even during the semester.

Under the following circumstances listed below, students who wish to register for a particular language course must apply for a “Placement Test” (refer to p.119 - 120) in order to be placed into a course appropriate to their proficiency. The “Placement Test” will be held at the beginning of each semester. Students who fail to take the test will not be able to register for the language course during that particular semester. For information on language courses that do not hold the “Placement Test” (Russian, Portuguese, Latin, Asian and African Languages), be sure to check the information posted on the Loyola University Bulletin Board “Language Courses • LLC” before the course registration period of each semester.

This applies to students who have:

- studied the language before enrolling in university
- a family member who is a speaker of the language, and they are exposed to the language on a daily basis
- either lived or studied in a place where the language is used
- have experience of using the language for reasons not stated above

- Students are allowed to take up to 2 credits per language each semester. This limitation does not apply to advanced courses, optional courses, Short-term Language Programs during spring/summer vacation and Japanese offered by the CLER.
- The chosen language must be taken in the correct sequence. (Russian, Portuguese, Latin, Asian and African Languages courses start from the spring semester.)
- In principle, language courses cannot be taken repeatedly unless otherwise mentioned. Chinese, French, Spanish, German, Italian and Korean 1 credit advanced courses (上級科目 Advanced A to H or A to P) can be taken repeatedly as long as the courses are taught by different teachers. However, 2 credits advanced courses (Advanced [Integrated Skills] A to D) cannot be taken more than once.

- When students take advanced courses, they can start from any advanced courses.
- For lottery courses, lottery entry is available only for journalism students taking language courses as the Specialized Education (SE), Compulsory Elective courses. All the SPSF students who wish to study a language course as GS or SE Electives, may register for any available courses from the lottery registration period (first-come-first-served basis). For details, please refer to the p.28 about course registration procedure and schedule.
- As the number of “Advanced” courses is limited, students who wish to take courses at this level may experience conflicts in their class schedule, which may prevent them from earning enough credits necessary for graduation. Be sure to plan which courses you are going to take, referring to the chart in the Bulletin that shows the required number of credits for graduation.

● COURSE REGISTRATION FOR CHINESE, FRENCH, and SPANISH

- For basic and intermediate courses, students should take courses offered for SPSF and FLA students and should not take courses offered for students in other departments. Advanced courses are offered for students of all faculties.
 - Except for Chinese, students have the option of taking 1 credit advanced courses (上級科目 Advanced A to H or A to P) in addition to 2 credits advanced courses (Advanced [Integrated Skills] A to D). Please refer to the pages on the *Gogaku Kamoku* (語学科目) in “2022 Academic Handbook (2022 年度履修要覧 [学部科目編] /2022 *Rishū Yōran*)” for more information.
- *As for Chinese, only 1 credit advanced courses are offered.

● COURSE REGISTRATION FOR JAPANESE LANGUAGE COURSES

Students who wish to take Japanese language courses should take the “Japanese Placement Test” offered by CLER to determine their Japanese language level. Students who have never studied Japanese do not need to take the test, but must submit the application form for JPN111 (JAPANESE 1) to CLER office by the deadline. For details regarding the Japanese language program and course registration for Japanese, please refer to “Japanese Language Program” brochure issued by CLER. Also check Loyola University Bulletin Board “Language courses • LLC” for course registration.

● COURSE REGISTRATION FOR OTHER LANGUAGES

Please refer to the pages on the *Gogaku Kamoku* (語学科目) in “2022 Academic Handbook (2022 年度履修要覧 [学部科目編] /2022 *Rishū Yōran*)” for more information.

Most German, Italian and Korean language courses are lottery courses. If students wish to register for the lottery courses as Elective courses, they can register the course from the lottery registration period (first-come-first served basis). The registration period and block which students can register for will differ, according to the students’ year and their category. For details, please refer to the pages on the *Gogaku Kamoku* (語学科目) in “2022 Academic Handbook (2022 年度履修要覧 [学部科目編] /2022 *Rishū Yōran*)”.

● PLACEMENT AT HIGHER LANGUAGE LEVEL

- Chinese, French, Spanish German, Italian, Korean
- Students who have previously studied or used the language of the course they are registering for must take a Placement Test. If they have studied the language in a Short-term Language Program during spring/summer vacation and wish to take a language course at a higher level, they must also take a Placement Test. As the number of “Advanced” courses is limited, students who wish to take courses at this level may experience conflicts in their class schedule, which may prevent them from earning enough credits necessary for graduation. Students should make sure to confirm the language credits necessary for graduation and plan accordingly.

● Take a Placement Test

- The Placement Test will be conducted at the beginning of each semester. Students must take a course at the level they were placed in as a result of the test.
- The information for the Placement Test will be posted on the Loyola University Bulletin Board “Language courses • LLC” before the course registration period of each semester.
- How the test will be conducted will differ depending on the language the students take.
- Once students are placed in a level after the test, they are not able to change the level. Also, students may not take a Placement Test with the purpose of being placed in a level lower than the current level.

- Russian, Portuguese, Latin, Asian and African Languages

Students who have studied or used the language prior to enrollment must refer to the information posted on the Loyola University Bulletin Board “Language courses • LLC” before the course registration period of each semester. With permission from the instructor in charge of the course, students may enroll in the intermediate or advanced level course. Students who have obtained permission to take intermediate or advanced level course must visit the Center for Academic Affairs during the registration period. The number of courses offered for some languages in the intermediate and advanced levels may not amount to the required number of credits for graduation, so students should make sure to check the corresponding language section for information on the number of credits offered. If students’ proficiency in the language exceeds the course goals and learning objectives, students will not be able to register for the course.

● OPTIONAL COURSES

(Language and Culture courses (ことばと文化), Seminar courses (演習) and Kentei Taisaku courses(検定対策))

- Optional Courses for Chinese, French, Spanish, German, Italian and Korean can be counted as GS Electives up to 8 credits. For departments which allow students to include language courses into their SE Electives, students can include optional courses into their SE Electives up to the number of credits stipulated by the departments. To take the above optional courses for Chinese, French, and Spanish, students are required to take a placement test at the beginning of the semester.
- For more information, please refer to the pages on the *Gogaku Kamoku* (語学科目) in “2022 Academic Handbook (2022年度履修要覧 [学部科目編])”.

● ATTENDANCE POLICY FOR LANGUAGE COURSES

NOTE: Attendance rules may be changed if the class format changes due to the spread of the new coronavirus infection.

After registering for courses be sure to check the guidance from the Language Education and Research Center on the Loyola University Bulletin Board “Language courses • LLC” before the start of the class.

In language courses offered by CLER, students are required to attend the following number of classes as listed below. Class attendance is essential for students’ learning and is considered a minimum condition for gaining credits for the course. A final grade will be considered based on the evaluation criteria stated in the syllabus of each course, only if the number of required attendance has been met. Meeting the attendance requirement does not guarantee passing course units. The number of required attendance is a minimum condition and any absences and/or tardies will affect the students’ grade.

Attendance will be counted from the first class meeting. When students attend a class in the first week but decide to withdraw from the course and register to a course with a different registration code, the attendance from the previous course(s) will not be transferred to the newly registered course.

CLER does not allow absences except for the “Special Consideration” cases described below. Therefore, job hunting, any events related to seminar or extracurricular activities, transportation delays and bereavement leaves are not included. Students should attend classes regularly in case of any sudden illness or any reasons other than the “Special Consideration” cases.

***For Attendance Policy of Japanese Language Courses, please refer to the “Japanese Language Program” brochure.**

• **Twice-a-week courses**

Total number of class sessions: **28 per semester**

Number of attendance required: At least 23 per semester

• **Once-a-week courses**

Total number of class sessions: **14 per semester**

Number of attendance required: At least 11 per semester

- **Special Consideration**

In any of the following conditions, neither your attendance nor absence will be counted. If applicable, please ask your instructor if you can receive this special treatment.

For up to three weeks, the special treatment will apply. As for the period of absence that goes beyond three weeks, regardless of the reasons you may have, the special treatment will not apply. In addition, if the absence is due to more than two circumstances stated below and exceeds three weeks, special consideration will not cover those additional days. Please ask your instructor about the required number of attendance when the special consideration is granted. If your instructor gives you an assignment to make up for your absence, the submission of the assignment becomes the prerequisite for receiving the special consideration.

1. A case of illness or injury where you submit a medical certificate indicating the necessary period of sick or injury leave. (*1)
2. When you join the annual Jo-Nan competition and submit an official certificate of participation.
3. When you have been officially assigned to be a lay judge (裁判員/Saiban In/) and must assume the duty.
4. When you submit a certificate that confirms your attendance at teaching practice, volunteer experience study (介護等体験/Kaigotou Taiken/), or museum practice (館務実習/Kanmu Jisshu).

(*1) If you have chronic medical conditions and cannot specify periods of sickness or injury leave, you should consult CLER Office (Floor 5, Bldg. 6) in advance. The deadline for informing the office is:

Friday, April 29 (Spring Semester) / Friday, October 14 (Autumn Semester)

- **Late Arrival**

Any students who fail to arrive within the first 30 minutes of a class will be regarded as being absent, even if he/she attends the rest of the class.

LANGUAGE COURSES (Except Japanese) OFFERED BY THE CENTER FOR LANGUAGE EDUCATION AND RESEARCH

Registration CD	Course CD	Course Title	Cr.	Semester Offered	Instructor	Student Year	Numbering	Remarks
ACHN1011	CHN101	BASIC CHINESE 1	2	SPR	FEI Yan/ZHANG Tong*	1 · 2 · 3 · 4	CHN180-01m00	[26]
ACHN1012	CHN101	BASIC CHINESE 1	2	AUT	FEI Yan/ZHANG Tong*	1 · 2 · 3 · 4	CHN180-01m00	[26]
ACHN1021	CHN102	BASIC CHINESE 2	2	SPR	HUANG Wanting/IZUMI Anna*	1 · 2 · 3 · 4	CHN190-01m00	[26]
ACHN1022	CHN102	BASIC CHINESE 2	2	AUT	HUANG Wanting/IZUMI Anna*	1 · 2 · 3 · 4	CHN190-01m00	[26]
ACHN1031	CHN103	INTERMEDIATE CHINESE 1	2	SPR	FEI Yan/SUGITANI Kota*	1 · 2 · 3 · 4	CHN280-01m00	[30]
ACHN1032	CHN103	INTERMEDIATE CHINESE 1	2	AUT	FEI Yan/SUGITANI Kota*	1 · 2 · 3 · 4	CHN280-01m00	[30]
ACHN1041	CHN104	INTERMEDIATE CHINESE 2	2	SPR	ZHANG Tong*/LIU Xiaomei*	1 · 2 · 3 · 4	CHN290-01m00	[30]
ACHN1042	CHN104	INTERMEDIATE CHINESE 2	2	AUT	ZHANG Tong*/LIU Xiaomei*	1 · 2 · 3 · 4	CHN290-01m00	[30]
LCHN3030	850760	ADVANCED CHINESE A	1	SPR	HUANG Wanting	1 · 2 · 3 · 4	CHN301-01m00	①
LCHN3040	850761	ADVANCED CHINESE B	1	AUT	HUANG Wanting	1 · 2 · 3 · 4	CHN302-01m00	①
LCHN3050	850762	ADVANCED CHINESE C	1	SPR	FEI Yan	1 · 2 · 3 · 4	CHN303-01m00	①
LCHN3060	850763	ADVANCED CHINESE D	1	AUT	FEI Yan	1 · 2 · 3 · 4	CHN304-01m00	①
AFRN1012	FRN101	BASIC FRENCH 1	2	AUT	MAILLEUX Coline/LE BOIS Jerome*	1 · 2 · 3 · 4	FRN180-01m00	[26]
AFRN101B	FRN101	BASIC FRENCH 1	2	SPR	DELMARE Gilles*	1 · 2 · 3 · 4	FRN180-01m00	[26]
AFRN1021	FRN102	BASIC FRENCH 2	2	SPR	DELMARE Gilles*	1 · 2 · 3 · 4	FRN190-01m00	
AFRN102B	FRN102	BASIC FRENCH 2	2	AUT	MAILLEUX Coline/LE BOIS Jerome*	1 · 2 · 3 · 4	FRN190-01m00	
AFRN1032	FRN103	INTERMEDIATE FRENCH 1	2	AUT	DELMARE Gilles*	1 · 2 · 3 · 4	FRN280-01m00	
AFRN103B	FRN103	INTERMEDIATE FRENCH 1	2	SPR	MAILLEUX Coline/LE BOIS Jerome*	1 · 2 · 3 · 4	FRN280-01m00	
AFRN1041	FRN104	INTERMEDIATE FRENCH 2	2	SPR	MAILLEUX Coline/LE BOIS Jerome*	1 · 2 · 3 · 4	FRN290-01m00	
AFRN104B	FRN104	INTERMEDIATE FRENCH 2	2	AUT	DELMARE Gilles*	1 · 2 · 3 · 4	FRN290-01m00	
AFRN2110	FRN211	ADVANCED FRENCH (INTEGRATED SKILLS) A	2	SPR	GAILLARD Nicolas*/DERIBLE Alberic*	1 · 2 · 3 · 4	FRN317-01m00	①
AFRN2120	FRN212	ADVANCED FRENCH (INTEGRATED SKILLS) B	2	AUT	DERIBLE Alberic*/GAILLARD Nicolas*	1 · 2 · 3 · 4	FRN318-01m00	①
LFRN3930	850496	ADVANCED FRENCH K	1	SPR	MAILLEUX Coline	1 · 2 · 3 · 4	FRN311-01m00	
LFRN3940	850497	ADVANCED FRENCH L	1	AUT	MAILLEUX Coline	1 · 2 · 3 · 4	FRN312-01m00	
LFRN3950	850498	ADVANCED FRENCH M	1	SPR	PIRIOU Vincent*	1 · 2 · 3 · 4	FRN313-01m00	
LFRN3960	850499	ADVANCED FRENCH N	1	AUT	KITAMURA Ayako	1 · 2 · 3 · 4	FRN314-01m00	②
LFRN3970	850500	ADVANCED FRENCH O	1	SPR	POUPI Damien*	1 · 2 · 3 · 4	FRN315-01m00	
LFRN3980	850467	ADVANCED FRENCH P	1	AUT	POUPI Damien*	1 · 2 · 3 · 4	FRN316-01m00	
ASPN1011	SPN101	BASIC SPANISH 1	2	SPR	ESGUERRA Paula*/FISZELEW Valeria*	1 · 2 · 3 · 4	HSP180-01m00	[26]
ASPN101A	SPN101	BASIC SPANISH 1	2	SPR	DE ARCOS PASTOR Angustias/ALASTRUEY Txabi*	1 · 2 · 3 · 4	HSP180-01m00	[26]
ASPN101B	SPN101	BASIC SPANISH 1	2	AUT	GARCÍA Carmen*/MARTÍNEZ Silvia*	1 · 2 · 3 · 4	HSP180-01m00	[26]
ASPN1022	SPN102	BASIC SPANISH 2	2	AUT	ESGUERRA Paula*/FISZELEW Valeria*	1 · 2 · 3 · 4	HSP190-01m00	[26]
ASPN102A	SPN102	BASIC SPANISH 2	2	SPR	DE ARCOS PASTOR Angustias	1 · 2 · 3 · 4	HSP190-01m00	
ASPN102B	SPN102	BASIC SPANISH 2	2	AUT	DE ARCOS PASTOR Angustias/ALASTRUEY Txabi*	1 · 2 · 3 · 4	HSP190-01m00	[26]
ASPN1031	SPN103	INTERMEDIATE SPANISH 1	2	SPR	FISZELEW Valeria*/ALASTRUEY Txabi*	1 · 2 · 3 · 4	HSP280-01m00	[30]
ASPN103A	SPN103	INTERMEDIATE SPANISH 1	2	AUT	DE ARCOS PASTOR Angustias	1 · 2 · 3 · 4	HSP280-01m00	
ASPN103B	SPN103	INTERMEDIATE SPANISH 1	2	SPR	DE ARCOS PASTOR Angustias/VEGA GONZÁLEZ Arturo*	1 · 2 · 3 · 4	HSP280-01m00	[30]
ASPN1042	SPN104	INTERMEDIATE SPANISH 2	2	AUT	FISZELEW Valeria*/ALASTRUEY Txabi*	1 · 2 · 3 · 4	HSP290-01m00	[30]
ASPN104A	SPN104	INTERMEDIATE SPANISH 2	2	AUT	DE ARCOS PASTOR Angustias/VEGA GONZÁLEZ Arturo*	1 · 2 · 3 · 4	HSP290-01m00	[30]
ASPN104B	SPN104	INTERMEDIATE SPANISH 2	2	SPR	GARCÍA Carmen*/MARTÍNEZ Silvia*	1 · 2 · 3 · 4	HSP290-01m00	
ASPN2110	SPN211	ADVANCED SPANISH (INTEGRATED SKILLS) A	2	SPR	DE ARCOS PASTOR Angustias/ASTIGUETA Bernardo*	1 · 2 · 3 · 4	HSP317-01m00	①
ASPN2120	SPN212	ADVANCED SPANISH (INTEGRATED SKILLS) B	2	AUT	DE ARCOS PASTOR Angustias/ASTIGUETA Bernardo*	1 · 2 · 3 · 4	HSP318-01m00	①
LSPN3410	850569	ADVANCED SPANISH A	1	SPR	YAMAURA Angela*	1 · 2 · 3 · 4	HSP301-01m00	①
LSPN3420	850570	ADVANCED SPANISH B	1	AUT	GUTIÉRREZ Carolina*	1 · 2 · 3 · 4	HSP302-01m00	①
LSPN3430	850571	ADVANCED SPANISH C	1	SPR	ALASTRUEY Txabi*	1 · 2 · 3 · 4	HSP303-01m00	①
LSPN3440	850572	ADVANCED SPANISH D	1	AUT	ALASTRUEY Txabi*	1 · 2 · 3 · 4	HSP304-01m00	①

[] = Lottery Course. Number in brackets is the capacity

Instructor's name with * = adjunct instructor

① = Offered every other year

② = Inclass lottery may be held in the first class. Details to be given on the syllabus.

For descriptions of the courses listed above, please refer to course syllabi on Loyola.

JAPANESE LANGUAGE PROGRAM (JLP)

The Center for Language Education and Research (CLER) offers multiple tracks and levels of Japanese language courses. The type of course a student initially enrolls in will depend on his/her language background. Placement into the JLP will be determined by a placement test. Students should consult the CLER about the Japanese Placement Test. Further information about the JLP can be found in the brochure “Japanese Language Program.”

LANGUAGE COURSES (Japanese) OFFERED BY THE CENTER FOR LANGUAGE EDUCATION AND RESEARCH

Registration CD	Course CD	Course Title	Cr.	Semester Offered	Instructor	Student Year	Numbering	Remarks
※1	JPN111	JAPANESE 1	4	SPR	STAFF	1・2・3・4	JPN111-01e00	
※1	JPN111	JAPANESE 1	4	AUT	STAFF	1・2・3・4	JPN111-01e00	
※1	JPN150	JAPANESE M1	4	SPR	STAFF	1・2・3・4	JPN150-01e00	
※1	JPN150	JAPANESE M1	4	AUT	STAFF	1・2・3・4	JPN150-01e00	
※1	JPN112	JAPANESE 2	4	SPR	STAFF	1・2・3・4	JPN112-01e00	
※1	JPN112	JAPANESE 2	4	AUT	STAFF	1・2・3・4	JPN112-01e00	
※1	JPN200	JAPANESE M2	4	SPR	STAFF	1・2・3・4	JPN200-01j00	
※1	JPN200	JAPANESE M2	4	AUT	STAFF	1・2・3・4	JPN200-01j00	
※1	JPN211	JAPANESE 3	4	SPR	STAFF	1・2・3・4	JPN211-01j00	
※1	JPN211	JAPANESE 3	4	AUT	STAFF	1・2・3・4	JPN211-01j00	
※1	JPN250	JAPANESE M3	4	SPR	STAFF	1・2・3・4	JPN250-01j00	
※1	JPN250	JAPANESE M3	4	AUT	STAFF	1・2・3・4	JPN250-01j00	
※1	JPN212	JAPANESE 4	4	SPR	STAFF	1・2・3・4	JPN212-01j00	
※1	JPN212	JAPANESE 4	4	AUT	STAFF	1・2・3・4	JPN212-01j00	
※1	JPN321	ADVANCED JAPANESE 1	4	SPR	STAFF	1・2・3・4	JPN321-01j00	
※1	JPN321	ADVANCED JAPANESE 1	4	AUT	STAFF	1・2・3・4	JPN321-01j00	
※1	JPN322	ADVANCED JAPANESE 2	4	SPR	STAFF	1・2・3・4	JPN322-01j00	
※1	JPN322	ADVANCED JAPANESE 2	4	AUT	STAFF	1・2・3・4	JPN322-01j00	
※1	JPN311	BUSINESS JAPANESE 1	2	SPR	STAFF	1・2・3・4	JPN311-01j00	[25]★
※1	JPN311	BUSINESS JAPANESE 1	2	AUT	STAFF	1・2・3・4	JPN311-01j00	★
※1	JPN312	BUSINESS JAPANESE 2	2	SPR	STAFF	1・2・3・4	JPN312-01j00	★
※1	JPN312	BUSINESS JAPANESE 2	2	AUT	STAFF	1・2・3・4	JPN312-01j00	★
※1	JPN315	BUSINESS JAPANESE (PREPARATION FOR INTERNSHIP)	1	SPR/AUT	YONEZAWA Masako	1・2・3・4	JPN315-01j00	★
※1	JPN180	INTENSIVE JAPANESE 1	8	SPR	STAFF	1・2・3・4	JPN180-01e00	
※1	JPN180	INTENSIVE JAPANESE 1	8	AUT	STAFF	1・2・3・4	JPN180-01e00	
※1	JPN270	INTENSIVE JAPANESE 2	8	SPR	STAFF	1・2・3・4	JPN270-01j00	
※1	JPN270	INTENSIVE JAPANESE 2	8	AUT	STAFF	1・2・3・4	JPN270-01j00	
※1	JPN280	INTENSIVE JAPANESE 3	8	SPR	STAFF	1・2・3・4	JPN280-01j00	
※1	JPN280	INTENSIVE JAPANESE 3	8	AUT	STAFF	1・2・3・4	JPN280-01j00	
※1	JPN370	INTENSIVE JAPANESE 4	8	SPR	STAFF	1・2・3・4	JPN370-01j00	
※1	JPN370	INTENSIVE JAPANESE 4	8	AUT	STAFF	1・2・3・4	JPN370-01j00	
AJPN340A	JPN340	READING & WRITING (BASICS)	2	SPR	STAFF	1・2・3・4	JPN340-01j00	
AJPN340I	JPN340	READING & WRITING (BASICS)	2	AUT	STAFF	1・2・3・4	JPN340-01j00	
AJPN341A	JPN341	READING & WRITING 1	2	SPR	STAFF	1・2・3・4	JPN341-01j00	
AJPN341I	JPN341	READING & WRITING 1	2	AUT	STAFF	1・2・3・4	JPN341-01j00	
AJPN342A	JPN342	READING & WRITING 2	2	SPR	STAFF	1・2・3・4	JPN342-01j00	
AJPN342I	JPN342	READING & WRITING 2	2	AUT	STAFF	1・2・3・4	JPN342-01j00	
AJPN343A	JPN343	READING & WRITING 3	2	SPR	STAFF	1・2・3・4	JPN343-01j00	
AJPN343I	JPN343	READING & WRITING 3	2	AUT	STAFF	1・2・3・4	JPN343-01j00	
AJPN349A	JPN349	JAPANESE LITERACY 1	2	SPR	STAFF	1・2・3・4	JPN349-01j00	
AJPN349B	JPN349	JAPANESE LITERACY 1	2	SPR	STAFF	1・2・3・4	JPN349-01j00	
AJPN349I	JPN349	JAPANESE LITERACY 1	2	AUT	STAFF	1・2・3・4	JPN349-01j00	
AJPN353A	JPN353	JAPANESE LITERACY 2	4	SPR	STAFF	1・2・3・4	JPN353-01j00	
AJPN353I	JPN353	JAPANESE LITERACY 2	4	AUT	STAFF	1・2・3・4	JPN353-01j00	
AJPN4050	JPN405	TRANS ENG TO JPN :THEORY&PRAC1	4	SPR	KATORI Yoshikazu*	1・2・3・4	JPN405-01j00	
AJPN4060	JPN406	TRANS ENG TO JPN :THEORY&PRAC2	4	AUT	KATORI Yoshikazu*	1・2・3・4	JPN406-01j00	
AJPN407I	JPN407	TRANS JPN TO ENG :THEORY&PRAC	4	SPR	SHINODA Eri*	1・2・3・4	JPN407-01j00	
AJPN4072	JPN407	TRANS JPN TO ENG :THEORY&PRAC	4	AUT	SHINODA Eri*	1・2・3・4	JPN407-01j00	
AJPN431A	JPN431	ACADEMIC JAPANESE 1-1	2	SPR	SATO Kimiko	1・2・3・4	JPN431-01j00	
AJPN431B	JPN431	ACADEMIC JAPANESE 1-1	2	SPR	SATO Kimiko	1・2・3・4	JPN431-01j00	
AJPN431C	JPN431	ACADEMIC JAPANESE 1-1	2	SPR	HIROTA Taeko*	1・2・3・4	JPN431-01j00	
AJPN432A	JPN432	ACADEMIC JAPANESE 1-2	2	AUT	SATO Kimiko	1・2・3・4	JPN432-01j00	
AJPN432B	JPN432	ACADEMIC JAPANESE 1-2	2	AUT	SATO Kimiko	1・2・3・4	JPN432-01j00	
AJPN432C	JPN432	ACADEMIC JAPANESE 1-2	2	AUT	HIROTA Taeko*	1・2・3・4	JPN432-01j00	
AJPN4410	JPN441	ACADEMIC JAPANESE 2-1	2	SPR	URAWA Chie*	1・2・3・4	JPN441-01j00	
AJPN4420	JPN442	ACADEMIC JAPANESE 2-2	2	AUT	URAWA Chie*	1・2・3・4	JPN442-01j00	
AJPN120A	JPN120	JAPANESE TUTORIAL MODULE 2	4	SPR	STAFF*	1・2・3・4	JPN120-01j00	★★
AJPN123A	JPN123	REVIEW FOR JAPANESE TUTORIAL MODULE 2	2	SPR	STAFF*	1・2・3・4	JPN123-01e00	
AJPN220A	JPN220	JAPANESE TUTORIAL MODULE 3	4	SPR	STAFF*	1・2・3・4	JPN220-01j00	★★
AJPN223A	JPN223	REVIEW FOR JAPANESE TUTORIAL MODULE 3	2	SPR	STAFF*	1・2・3・4	JPN223-01j00	
AJPN230A	JPN230	JAPANESE TUTORIAL MODULE 4	4	SPR	STAFF*	1・2・3・4	JPN230-01j00	★★
AJPN120I	JPN120	JAPANESE TUTORIAL MODULE 2	4	AUT	STAFF*	1・2・3・4	JPN120-01j00	★★
AJPN123I	JPN123	REVIEW FOR JAPANESE TUTORIAL MODULE 2	2	AUT	STAFF*	1・2・3・4	JPN123-01e00	
AJPN220I	JPN220	JAPANESE TUTORIAL MODULE 3	4	AUT	STAFF*	1・2・3・4	JPN220-01j00	★★
AJPN223I	JPN223	REVIEW FOR JAPANESE TUTORIAL MODULE 3	2	AUT	STAFF*	1・2・3・4	JPN223-01j00	
AJPN230I	JPN230	JAPANESE TUTORIAL MODULE 4	4	AUT	STAFF*	1・2・3・4	JPN230-01j00	

[] = Lottery Course. Number in brackets is the capacity.

Instructor's name with * = adjunct instructor

※1: Please see the JPT result and timetable on Loyola.

★ These courses can be counted as Electives only.

★★ These courses are offered during Summer / Spring vacation.

For descriptions of the courses listed above, please refer to course syllabi on Loyola.

Department of Journalism SPSF Curriculum

Education and Research Objectives

To study the social roles, functions and influences of all aspects of journalism and media communication, and investigate a broad range of problems in news reporting and media.

Human Resource Development Objectives

To produce graduates well-versed in the types of communication required of a fully-fledged member of society, with advanced communicative skills and media literacy.

Diploma policy

The Department of Journalism sets standards for the skills and knowledge students should acquire before graduation as follows. Those who fulfill the graduation requirements shall be deemed to have acquired these qualities and will be awarded a diploma.

1. Accumulation of academic knowledge of the various disciplines of journalism, media communications, information, etc. and the practical skills to engage in research, analysis, critical thinking, structuring and presentation based on such knowledge.
2. The ability to learn from both dimensions of “theory and practice and to be a leading player in journalism or other fields that deal with media communications and information
3. High-level communication skills and media literacy to live the informatizing modern world

In addition to the above, the SPSF course sets the following abilities which students should acquire before graduation as common requirements across its six departments (Department of Journalism, Department of Education, Department of Sociology, Department of Economics, Department of Management, Department of Global Studies).

4. The ability to learn the basic knowledge on “Sustainable Futures,” to understand its importance, and to take action towards resolving challenges to the sustainable futures by drawing upon their academic discipline as well as from the other five disciplines in the SPSF course they learn.
5. The ability to understand and apply the interdisciplinary perspectives and methodologies, learned in their academic discipline and in the other five disciplines of the SPSF course, when addressing issues and presenting their ideas.

Curriculum policy

In accordance with the Diploma Policy, the Department of Journalism constructs its curriculum with courses aligned to the following purposes:

1. To have students study the fields of journalism, media communication and information taking a theoretical approach, media-specific approach, international approach, and realistic problem analysis approach.
2. To achieve a “broad education that is biased to neither theory nor practice” by balancing the abovementioned curriculum with a practical approach aimed at improving such expressive skills, verification skills and critical skills
3. To nurture critical perspectives, research and analytical skills, and ethics in small-group education, by enrolling all students in individual seminars taught by full-time faculty members.
4. To require students to compile a thesis under the individual guidance of a full-time faculty member as a culmination of the knowledge, analytical skills and other skills acquired during the four years of enrollment.

In addition to the above, the SPSF course constructs its curriculum in the following manner, for the purpose of achieving the common diploma policy across the six departments:

5. To enable the students during the first year to acquire a basic knowledge on “Sustainable Futures” and the relating issues through the SPSF General Studies Courses, drawing on the perspectives of six disciplines. Based on the acquired knowledge, the students will be able to deepen their understanding in various challenges related to the sustainable futures through Elective Courses in the University-wide General Studies Courses, and they will be also able to learn about the approaches, contents, and methodologies of the different disciplines through

Specialized Courses offered by each department.

6. To enable students to gradually gain knowledge of the different disciplines of each Department and also acquire a wide range of knowledge through the courses offered by other faculties and departments which have been designated to offer Elective Compulsory Courses or Elective Courses. Thus, the students will be able to acquire the various perspectives, contents, and methodologies, as well as comprehensive approaches from the courses.

1. Courses and Minimum Number of Credits Required for Graduation

【For students who entered in 2022】

General Studies (Zengaku Kyotsu Kamoku)

Compulsory: 8 credits (Studies in Christian Humanism: For Others, With Others, Liberal Arts of the Body: 1 Credit, Critical Thinking & Discussion, Overview of Data Science, Thinking about Issues, Perspectives and Positionality: 2 Credits)

Compulsory electives: 6 credits (Studies in Christian Humanism: 2 Credits, Advanced General Education Courses: 4 Credits (including SPSF Common Core: Theme Based "Third Year Seminar for Sustainable Futures" 2 credits)

Electives: 12 credits
(including SPSF Common Core: Theme Based "First Year Lecture in/about Sustainable Futures" 4 credits)

Language

Compulsory: 4 credits (SPSF Common Core: Academic Writing 1&2)

Specialized Education (Gakka Kamoku)

Compulsory: 14 credits

Electives: 80 credits (including SPSF Common Core: Academic Skills 2 credits)

Total: 124 credits are required for graduation.

【For students who entered in 2021】

General Studies (Zengaku Kyotsu Kamoku)

Compulsory: 2 credits (Health and Physical Education: 2 credits)

Compulsory electives: 4 credits (Studies in Christian Humanism)

Electives: 20 credits
(including SPSF Common Core: Theme Based "First Year Lecture in/about Sustainable Futures", "Third Year Seminar for Sustainable Futures (Advanced General Education course) " 6 credits)

Language

Compulsory: 4 credits (SPSF Common Core: Academic Writing 1&2)

Specialized Education (Gakka Kamoku)

Compulsory: 14 credits

Electives: 80 credits (including SPSF Common Core: Academic Skills 4 credits)

Total: 124 credits are required for graduation.

2. Distribution of Required Credits

Please see page 127.

3. Guidelines for Course Registration

- ① For general information for SPSF students, refer to the "For all SPSF students" page on p.104.
- ② For General Studies information, refer to the "General Studies" page on p.106.
- ③ For Language courses information, refer to the "Language" page on p.115.
- ④ Students are required to write their bachelor's thesis in accordance with the guidance of their supervisor.
- ⑤ Information on Department of Journalism Specialized Education

1. Refer to the "Student Year" column in the Specialized Education Courses (p.129) for the year in which you can take each course. If the student does not satisfy the "Student Year", the course cannot be taken in other departments or the Department of Journalism.
2. If a student earns more than 26 credits in Compulsory Elective courses, they will be regarded as SE Electives in the Department of Journalism and counted towards graduation requirements.
3. Some SE courses offer the same content in English and Japanese. Students can only take one or the other. For details, refer to the Course list for the Department of Journalism on p.184 in the remarks.
4. Up to 12 credits of Compulsory Elective courses in the Japanese Track can be applied towards graduation requirements as SE Compulsory Electives.
Note: Students can take a maximum of 24 credits for the courses in the Japanese Track.
5. Up to 12 credits of courses from other departments (excluding language courses) and Course(s) for Teacher & Curator Certification, with course numbers starting with 62, except "Teaching Practice 1, 2, 3 (教育実習 1、2、3)" and "Museum Curator Field Work 1, 2 (博物館実習 1、2)" can be applied towards graduation requirements as SE Electives. Students should consult with the instructor in charge of the seminar before selecting courses.
6. Up to 12 credits of General Studies, excluding "Compulsory" and "SPSF Common Core (Theme Based)", can be applied towards graduation requirements as SE Electives in the Department of Journalism.
7. As for 5) and 6) above, note that only a total of 12 credits can be applied towards graduation requirements.

⑥ Course Numbering

Numbering shown in the list of assigned courses refer to the following. For information about numbering, refer to p.24.

Field (alphabets)	Field (English)
JRN	Journalism

4. Distribution of Required Credits

[For students who entered from 2022]Department of Journalism

O General Studies: University-Wide General Studies (26 credits)

	1st Year		2nd Year		3rd Year		4th Year	
	Autumn Semester course title	Spring Semester course title	Autumn Semester course title	Spring Semester course title	Autumn Semester course title	Spring Semester course title	Autumn Semester course title	Spring Semester course title
Compulsory	8 cr	Studies in Christian Humanism: For Others, With Others	1 Critical Thinking & Discussion	2				
		Liberal Arts of the Body Thinking about Issues, Perspectives and Positionality	1 Overview of Data Science	2				
Compulsory Electives	6 cr	Studies in Christian Humanism	2					
		Advanced General Education Courses						2
Electives	12 cr	SPSF Common Core(Theme Based)	4		Third Year Seminar for Sustainable Futures	2		
		SPSF Common Core(Theme Based)						
Electives	12 cr	First Year Lecture in/about Sustainable Futures	4					
		General Studies Elective Courses taught in English						
Electives	12 cr	First-year students may take General Studies Elective Courses up to 4 credits each semester						
		Language(s): up to 8 cr※1,2						
Electives	12 cr	Credits earned in excess of 6 credits in Compulsory Electives will be counted into Electives.						

O Language (4 credits)

	1st Year		2nd Year		3rd Year		4th Year	
	Autumn Semester course title	Spring Semester course title	Autumn Semester course title	Spring Semester course title	Autumn Semester course title	Spring Semester course title	Autumn Semester course title	Spring Semester course title
Compulsory	4 cr	Academic Writing 1	2	Academic Writing 2	2			

O Specialized Education (94 cr)

	1st Year		2nd Year		3rd Year		4th Year	
	Autumn Semester course title	Spring Semester course title	Autumn Semester course title	Spring Semester course title	Autumn Semester course title	Spring Semester course title	Autumn Semester course title	Spring Semester course title
Compulsory	14 cr	Communication 1	2 SEMINAR 1 (MEDIA RESEARCH)	2 Seminar 2A	1 Seminar 2B	1 Seminar 3A	1 Seminar 4A	1 Seminar 4B
Compulsory Electives	2 cr	Academic Presentations	2					
		Language(One Language): Course(s) taught in English (Japanese, Chinese, French, Spanish)						
Compulsory Electives	26 cr	Own Department's Compulsory Elective Course(s)						
		Course(s) taught in Japanese, Own Department's Compulsory Elective Course(s) only, up to 12※1						
Electives	52 cr	Own Compulsory Elective and Elective course(s)※1						
		Up to 12 cr						
Electives	52 cr	Other Faculty/Department Course(s)※1						
		Course(s) for Teacher & Curator Certification with course numbers starting with 62, except "Teaching Practice 1, 2, 3 (教育実習1, 2, 3)" and "Museum Curator Field Work 1, 2 (博物館実習1, 2)"※1						
Electives	52 cr	General Studies Course(s) taught in English except "Compulsory" and "SPSF Common Core (Theme Based)"						
		Up to 8 cr						
Electives	52 cr	Language(s): Course(s) taught in English (Japanese, Chinese, French, Spanish)※2						
		8						
Electives	18	Course(s) taught in Japanese, Own Department's Compulsory Elective Course(s) only, up to 12※1						
		18						

※1 No more than 24 credits of courses taught in Japanese in total.

※2 For details regarding Language courses, see p.117, "LANGUAGES (OTHER THAN ENGLISH)" and SPSF Language Courses chart.

【For students who entered in 2021】Department of Journalism

○ General Studies: University-Wide General Studies (26 credits)

	1st Year		2nd Year		3rd Year		4th Year	
	Autumn Semester course title	Spring Semester course title	Autumn Semester course title	Spring Semester course title	Autumn Semester course title	Spring Semester course title	Autumn Semester course title	Spring Semester course title
Compulsory								
Compulsory Electives	2 cr Health and Physical Education	2						
Compulsory Electives	4 cr Studies in Christian Humanism	4						
Electives	6 cr SPSF Common Core (Theme Based)	4 First Year Lecture in/about Sustainable Futures				2 Third Year Seminar for Sustainable Futures (Advanced General Education course)		
	14 cr Electives	- General Studies Elective Courses taught in English - Language(s): up to 8 cr※1,3						

○ Language (4 credits)

	1st Year		2nd Year		3rd Year		4th Year	
	Autumn Semester course title	Spring Semester course title	Autumn Semester course title	Spring Semester course title	Autumn Semester course title	Spring Semester course title	Autumn Semester course title	Spring Semester course title
Compulsory	4 cr Academic Writing 1	2 Academic Writing 2						

○ Specialized Education (94 cr)

	1st Year		2nd Year		3rd Year		4th Year	
	Autumn Semester course title	Spring Semester course title	Autumn Semester course title	Spring Semester course title	Autumn Semester course title	Spring Semester course title	Autumn Semester course title	Spring Semester course title
Compulsory	14 cr Communication 1	2 SEMINAR 1 (MEDIA RESEARCH)	2 Seminar 2A	1 Seminar 2B	1 Seminar 3A	1 Seminar 3B	1 Seminar 4A	2 Seminar 4B
Compulsory Electives	4 cr Academic Presentations	2 Critical Thinking & Discussion	Language(One Language): Course(s) taught in English (Japanese, Chinese, French, Spanish)					
Electives	26 cr Compulsory Electives	Own Department's Compulsory Elective Course(s) Course(s) taught in Japanese: Own Department's Compulsory Elective Course(s) only, up to 12※1						
	50 cr SE Electives	- Own Compulsory Elective and Elective course(s)※1,2 Up to 12 cr - Other Faculty/Department Course(s)※1 - Course(s) for Teacher & Curator Certification with course numbers starting with 62, except "Teaching Practice 1, 2, 3 (教育実習1, 2, 3)" and "Museum Curator Field Work 1, 2 (博物館実習1, 2)"※1 - General Studies Course(s) taught in English except "Compulsory(HPE)" and "SPSF Common Core (Theme Based)" Up to 8 cr - Language(s): Course(s) taught in English (Japanese, Chinese, French, Spanish)※3						

※1 No more than 24 credits of courses taught in Japanese in total.

※2 No Constraints: "English for Journalism" (course OD: 854804, 854805) are not included in graduation requirements.

※3 For details regarding Language courses, see p.117, "LANGUAGES (OTHER THAN ENGLISH)" and SPSF Language Courses chart.

5. Specialized Education Courses

Please refer to All SPSF Course List (p.184~p.190) of the departments which offer the courses for detailed information.

Journalism: p.184 Education: p.185 Sociology: p.186 Economics: p.187 Management:p.188 Global Studies:p.189 Other departments:p.190

Compulsory

Registration CD	Course CD	Course title	Cr.	Semester offered	Instructor	Student Year	Course Offering Department
HJNS1010	268801	COMMUNICATION 1	2	AUT	KUNIEDA, Tomoki	1	Journalism
HJNS1020	268802	SEMINAR 1 (MEDIA RESEARCH)	2	SPR	ARUN, D Souza	1	Journalism
HJNS2011	268803	SEMINAR 2A	1	AUT	KUNIEDA, Tomoki	2	Journalism
HJNS2012	268803	SEMINAR 2A	1	AUT	ARUN, D Souza	2	Journalism
HJNS2021	268804	SEMINAR 2B	1	Not Offered	KUNIEDA, Tomoki	2	Journalism
HJNS2022	268804	SEMINAR 2B	1	Not Offered	ARUN, D Souza	2	Journalism
HJNS3011	268805	SEMINAR 3A	1	Not Offered	KUNIEDA, Tomoki	3	Journalism
HJNS3012	268805	SEMINAR 3A	1	Not Offered	ARUN, D Souza	3	Journalism
HJNS3021	268806	SEMINAR 3B	1	Not Offered	KUNIEDA, Tomoki	3	Journalism
HJNS3022	268806	SEMINAR 3B	1	Not Offered	ARUN, D Souza	3	Journalism
HJNS4011	268807	SEMINAR 4A	1	Not Offered	KUNIEDA, Tomoki	4	Journalism
HJNS4012	268807	SEMINAR 4A	1	Not Offered	ARUN, D Souza	4	Journalism
HJNS4021	268808	SEMINAR 4B	1	Not Offered	KUNIEDA, Tomoki	4	Journalism
HJNS4022	268808	SEMINAR 4B	1	Not Offered	ARUN, D Souza	4	Journalism
HJNS4030	268809	BACHELOR'S THESIS A	2	Not Offered	Staff	4	Journalism
HJNS4040	268810	BACHELOR'S THESIS B	2	Not Offered	Staff	4	Journalism

Compulsory Electives

Registration CD	Course CD	Course title	Cr.	Semester offered	Instructor	Student Year	Course Offering Department
HJNS5010	268811	INTERNATIONAL COMMUNICATION 1	2	AUT	*HWANG, Seongbin	2~4	Journalism
HJNS5020	268812	INTERNATIONAL COMMUNICATION 2	2	Not Offered	*HWANG, Seongbin	2~4	Journalism
HJNS5030	268813	MASS MEDIA 1	2	Not Offered	KUNIEDA, Tomoki	3~4	Journalism
HJNS5040	268814	MASS MEDIA 2	2	Not Offered	KUNIEDA, Tomoki	3~4	Journalism
HJNS5070	268817	REPORTING IN ENGLISH 1	2	Not Offered	Staff	3~4	Journalism
HJNS5080	268818	REPORTING IN ENGLISH 2	2	Not Offered	Staff	3~4	Journalism
HJNS5090	268819	REPORTING IN ENGLISH 3	2	Not Offered	Staff	3~4	Journalism
HJNS5050	268815	ETHICS OF MASS COMMUNICATION 1	2	Not Offered	Staff	3~4	Journalism
HJNS5060	268816	ETHICS OF MASS COMMUNICATION 2	2	Not Offered	Staff	3~4	Journalism
HEDS1010	147000	INTRODUCTION TO COMPARATIVE EDUCATION	2	AUT		2~4	Education
HSCS1010	289200	PRINCIPLES OF SOCIOLOGY	2	AUT		1~4	Sociology
HSCS1030	289202	QUANTITATIVE METHODS IN SOCIOLOGY	2	SPR		1~4	Sociology
HSCS5030	289221	CONTEMPORARY SOCIAL PROBLEMS	2	SPR		2~4	Sociology
HSCS2030	289203	QUALITATIVE METHODS IN SOCIOLOGY	2	AUT		2~4	Sociology
HSCS5040	288807	SOCIAL CHANGE IN POSTWAR JAPAN	2	Not Offered		2~4	Sociology
HSCS2010	289204	SOCIOLOGICAL THEORY 1	2	AUT		2~4	Sociology
HSCS2020	289205	SOCIOLOGICAL THEORY 2	2	SPR		2~4	Sociology
HSCS5060	289222	SOCIOLOGY OF FAMILIES	2	Not Offered		2~4	Sociology
HSCS5050	284930	SOCIOLOGY OF GLOBALIZATION	2	SPR		2~4	Sociology
HSCS5010	289220	SOCIOLOGY OF HAPPINESS	2	AUT		2~4	Sociology

Registration CD	Course CD	Course title	Cr.	Semester offered	Instructor	Student Year	Course Offering Department
HSCS5020	288893	WORK AND EMPLOYMENT IN JAPAN	2	AUT		2~4	Sociology
HSCS5130	289226	ENVIRONMENTAL SOCIOLOGY	2	Not Offered		3~4	Sociology
HSCS5110	289224	SPECIAL TOPICS IN SOCIOLOGY 1	2	1Q		3~4	Sociology
HSCS5120	289225	SPECIAL TOPICS IN SOCIOLOGY 2	2	AUT		3~4	Sociology
EECS1002	498008	INTRODUCTION TO MACROECONOMICS	2	Not Offered		1~4	Economics
EECS1001	498007	INTRODUCTION TO MICROECONOMICS	2	AUT		1~4	Economics
EECS1003	498017	INTRODUCTION TO STATISTICS	2	SPR		1~4	Economics
EECS1004	498009	INTRODUCTION TO DATA ANALYSIS	2	AUT		2~4	Economics
EMGS5001	468058	PRINCIPLES OF ACCOUNTING	2	AUT		1~4	Management
EMGS5032	468033	PRINCIPLES OF MANAGEMENT	2	AUT		1~4	Management
EMGS5047	468039	PRINCIPLES OF MARKETING	2	AUT		1~4	Management
EMGS5037	468052	STRATEGIC MANAGEMENT	2	SPR		2~4	Management
EMGS5038	468068	CHALLENGING FRONTLINE ISSUES IN GLOBAL BUSINESS	4	SPR		3~4	Management
BGSS1030	BGSS1030	INTRODUCTION TO AREA STUDIES	2	AUT		1~4	Global Studies
BGSS1010	BGSS1010	INTRODUCTION TO GLOBAL STUDIES	2	AUT		1~4	Global Studies
BGSS1020	BGSS1020	INTRODUCTION TO INTERNATIONAL RELATIONS	2	AUT		1~4	Global Studies
BGSS3004	BGS20001	BASICS OF SOUTHEAST ASIAN STUDIES B	2	SPR		2~4	Global Studies
LAW68200	338010	INTERNATIONAL POLITICAL ECONOMY	2	SPR		3~4	Law
APOL3540	POL354	GLOBAL POLITICAL ECONOMY	4	Not Offered		3~4	FLA
APOL3210	POL321	JAPANESE GOVERNMENT AND POLITICS	4	SPR		3~4	FLA
APOL3070	POL307	POLITICAL ECOLOGY	2	SPR		3~4	FLA

SE Electives

Registration CD	Course CD	Course title	Cr.	Semester offered	Instructor	Student Year	Course Offering Department
HEDS1040	147004	CURRICULUM AND INSTRUCTION	2	SPR		2~4	Education
HEDS1030	147003	EDUCATION AND INTERNATIONAL DEVELOPMENT	2	AUT		2~4	Education
HEDS1020	147002	INTERNATIONAL EDUCATION	2	SPR		2~4	Education
HEDS5010	147021	SPECIAL TOPICS IN EDUCATION 1: PHILOSOPHY OF EDUCATION	2	AUT		2~4	Education
HEDS5020	147022	SPECIAL TOPICS IN EDUCATION 2: SOCIOLOGY OF EDUCATION	2	Not Offered		2~4	Education
HEDS5030	147023	SPECIAL TOPICS IN EDUCATION 3: CURRENT ISSUES IN EDUCATION IN ASIA	2	AUT		2~4	Education
EECS5020	498015	ASIAN ECONOMY	2	AUT		2~4	Economics
EECS5008	402110	CONTEMPORARY ISSUES IN INTERNATIONAL DEVELOPMENT	2	SPR		2~4	Economics
EECS5025	402080	ENVIRONMENTAL AND NATURAL RESOURCE ECONOMICS	2	SPR		2~4	Economics
EECS5026	402100	GAME THEORY	2	AUT		2~4	Economics
EECS5007	467969	GLOBAL DEVELOPMENT GOALS	2	AUT		2~4	Economics
EECS5005	402090	GLOBAL ECONOMIC HISTORY	2	Not Offered		2~4	Economics
EECS5001	402060	INTERNATIONAL ECONOMICS AND BUSINESS	2	AUT		2~4	Economics
EECS5024	498010	INTERNATIONAL FINANCE	2	SPR		2~4	Economics
EECS5004	402120	JAPANESE ECONOMY 1	2	Not Offered		2~4	Economics
EECS5011	498014	POVERTY IN THE GLOBAL ECONOMY	2	2Q		2~4	Economics
EECS5002	498024	PUBLIC ECONOMICS 1	2	SPR		2~4	Economics

Registration CD	Course CD	Course title	Cr.	Semester offered	Instructor	Student Year	Course Offering Department
EECS5030	498028	QUANTITATIVE ANALYSIS OF SOCIAL ISSUES	2	SPR		2~4	Economics
EECS5031	498029	ECONOMICS OF SOCIAL POLICY	2	AUT		2~4	Economics
EMGS5044	468036	CONSUMER BEHAVIOR 1	2	SPR		2~4	Management
EMGS5045	468037	CONSUMER BEHAVIOR 2	2	AUT		2~4	Management
EMGS5004	468059	FINANCIAL ACCOUNTING 1	2	SPR		2~4	Management
EMGS5005	468060	FINANCIAL ACCOUNTING 2	2	AUT		2~4	Management
EMGS5041	468050	FUNDAMENTALS OF ACCOUNTING 1	2	Not Offered		2~4	Management
EMGS5042	468051	FUNDAMENTALS OF ACCOUNTING 2	2	AUT		2~4	Management
EMGS5050	468048	GLOBAL MARKETING 1	2	Not Offered		2~4	Management
EMGS5051	468049	GLOBAL MARKETING 2	2	1Q		2~4	Management
EMGS5039	468034	MANAGEMENT ACCOUNTING 1	2	Not Offered		2~4	Management
EMGS5040	468035	MANAGEMENT ACCOUNTING 2	2	Not Offered		2~4	Management
EMGS5048	468040	MARKETING STRATEGY 1	2	SPR		2~4	Management
EMGS5049	468041	MARKETING STRATEGY 2	2	AUT		2~4	Management
EMGS5035	468046	ORGANIZATIONAL BEHAVIOR	2	Not Offered		2~4	Management
EMGS5036	468047	ORGANIZATIONAL THEORY AND ANALYSIS	2	AUT		2~4	Management
EMGS5052	468069	ENTREPRENEURSHIP 1	2	SPR		2~4	Management
EMGS5053	468070	ENTREPRENEURSHIP 2	2	AUT		2~4	Management
EMGS5043	408010	GLOBAL BRANDING	2	AUT		3~4	Management
EMGS5027	468062	INTERNATIONAL ACCOUNTING	2	SPR		3~4	Management
EMGS5033	468044	SPECIAL TOPICS IN MANAGEMENT 1	2	AUT		3~4	Management
EMGS5034	468045	SPECIAL TOPICS IN MANAGEMENT 2	2	SPR		3~4	Management
EMGS5046	468038	SPECIAL TOPICS IN MARKETING	2	2Q		2~4	Management
BGSS4005	BGS57507	ADVANCED STUDIES (CONTEMPORARY SOCIETIES OF ASIA)	2	SPR		3~4	Global Studies
BGSS3013	BGS20006	BASICS OF THEORIES OF CIVIL SOCIETY B	2	AUT		3~4	Global Studies
BGSS3014	BGS20007	CONFLICT RESOLUTION B	2	AUT		3~4	Global Studies
BGSS3015	BGS59000	PEACE RESEARCH	2	SPR		3~4	Global Studies
BGSS3007	BGS57900	SOCIETY AND POLITICS IN SOUTH ASIA	2	AUT		3~4	Global Studies
BGSS3005	BGS58500	THEORY OF INTERNATIONAL POLITICS	2	AUT		3~4	Global Studies
BGSS4004	BGS57508	ADVANCED STUDIES (CULTURES AND SOCIETIES OF ASIA)	2	SPR		3~4	Global Studies
BGSS4006	BGS57517	ADVANCED STUDIES (GLOBAL MIGRATION AND KOREANS IN JAPAN)	2	AUT		3~4	Global Studies
BGSS4001	BGS57516	ADVANCED STUDIES (INTERNATIONAL HUMAN RIGHTS)	2	SPR		3~4	Global Studies
BGSS4002	BGS25000	ADVANCED STUDIES (DEMOCRACY AND CONFLICT)	2	SPR		3~4	Global Studies
BGSS4003	BGS57505	ADVANCED STUDIES (INTERNATIONAL ORGANIZATION B)	2	SPR		3~4	Global Studies
BGSS3017	BGS20008	MODERN HISTORY OF THE MIDDLE EAST B	2	AUT		3~4	Global Studies

Instructor's name with * = adjunct instructor

Department of Education SPSF Curriculum

Education and Research Objectives

The Department of Education aims to explore and understand various issues and problems relating to education and human development using comprehensive and multi-faceted approaches grounded in the discipline of education studies, and to enhance education that values human dignity.

Human Resource Development Objectives

The goals of teaching at the Department of Education are to prepare future educators and researchers with outstanding expertise and human qualities founded on respect for human dignity, and to educate the next generation of global and autonomous citizens with a broad knowledge of educational studies.

Diploma policy

The Department of Education sets standards for the competencies students should acquire before graduation. Those who fulfill the graduation requirements described below shall be deemed to have acquired these qualities and will be awarded a diploma.

1. The ability to understand what it means to consider various issues relating to education and human development from the perspective of educational studies as an academic discipline, and to envision educational practices respectful of human dignity. This requires students to have acquired a broad knowledge of educational studies and other relevant studies.
2. The ability to analyze and understand educational practices, phenomena and issues in schools, households, companies and society at large, using the knowledge and methodologies of educational studies informed by philosophy, history, sociology and psychology, as well as to comprehensively and multifacetedly explore pathways to realize education respectful of human dignity, and present their ideas clearly.
3. The ability to actively and respectfully collaborate with people from diverse backgrounds to solve educational problems, and achieving – through constant self-reflection – an education founded on respect for human dignity and imbued with an international perspective.

In addition to the above, the SPSF course sets the following abilities which students should acquire before graduation as common requirements across its six departments (Department of Journalism, Department of Education, Department of Sociology, Department of Economics, Department of Management, Department of Global Studies).

4. The ability to learn the basic knowledge on “Sustainable Futures,” to understand its importance, and to take action towards resolving challenges to the sustainable futures by drawing upon their academic discipline as well as from the other five disciplines in the SPSF course they learn.
5. The ability to understand and apply the interdisciplinary perspectives and methodologies, learned in their academic discipline and in the other five disciplines of the SPSF course, when addressing issues and presenting their ideas.

Curriculum policy

In accordance with the Diploma Policy, the Department of Education offers its curriculum as follows:

1. As with other departments of the Faculty of Human Sciences, the curriculum comprises university-wide general courses, language courses, and departmental major courses with an aim to achieve a harmonious combination of a broad knowledge base and discipline-specific expertise.
2. In order to enable students to examine educational issues from an international perspective while understanding the unique academic features of educational studies as an academic discipline, the Department of Education offers sub-discipline courses dealing with international dimensions of education, such as Comparative Education, International Education, and Education and International Development at the core, as well as courses in Philosophy of Education, Sociology of Education, and Curriculum and Instruction.
3. During the freshman and sophomore years, students are expected to enhance their critical thinking and communication skills, which will serve as the foundation of academic research skills. They are also expected to acquire basic knowledge, perspectives and methodologies relevant to educational studies.

During the junior year, students select a seminar based on what they have learned during their freshman and sophomore years, in order to acquire basic research methods as well as further hone their critical thinking, judgment and presentation skills. Students also decide on and pursue their own research topic, develop skills to examine phenomena from the perspectives of educational studies, seek pathways to solve problems in educational settings, and cultivate an attitude respectful of human dignity.

During the senior year, students engage in thesis research or a project in order to comprehensively and multifacetedly explore pathways to realize education respectful of human dignity, present their ideas clearly, and acquire the qualities and skills to persistently engage in problem-solving through constant self-reflection.

4. While students systematically and holistically learn the curriculum of educational studies, they will also explore sustainability issues from multiple perspectives by taking courses from other SPSF departments and hone their skills in social and human science research. Furthermore, students will be able to develop the qualities of a global citizen by taking courses offered by faculties and departments outside SPSF, participating in a study abroad program, internship, and social engagement programs such as a study tour overseas. In addition, students with a certain level of Japanese proficiency may take Japanese-medium courses as electives, provided they observe certain requirements, such as the maximum number of credits allowed.
5. In the Department of Education, creative teaching methods have been introduced to achieve more autonomous and dialogue-based learning. At lectures, students are often required to complete “reaction papers” to which the instructor will provide comments in the following class or offer a summary of students’ reactions to the lecture, based on which students will engage in further debate. Seminars will be centered on individual or group presentations and debates, and may involve working collaboratively with students and faculties of other universities in and/or outside Japan or conducting fieldwork in Japan and/or overseas. The final thesis defense and evaluation of graduation project outcomes will be open to other students and faculty, and is an opportunity to perform a creative and effective presentation to a large audience.
6. Learning progress and outcomes of individual students will be monitored and evaluated by using the combination of various evaluation criteria and methods, such as reaction papers and worksheets used in class, participation in and contribution to debates and group work, reports and examinations given at mid-term and end-of-term.

In addition to the above, the SPSF course constructs its curriculum in the following manner, for the purpose of achieving the common diploma policy across the six departments:

7. To enable the students during the first year to acquire a basic knowledge on “Sustainable Futures” and the relating issues through the SPSF General Studies Courses, drawing on the perspectives of six disciplines. Based on the acquired knowledge, the students will be able to deepen their understanding in various challenges related to the sustainable futures through Elective Courses in the University-wide General Studies Courses, and they will be also able to learn about the approaches, contents, and methodologies of the different disciplines through Specialized Courses offered by each department.
8. To enable students to gradually gain knowledge of the different disciplines of each Department and also acquire a wide range of knowledge through the courses offered by other faculties and departments which have been designated to offer Elective Compulsory Courses or Elective Courses. Thus, the students will be able to acquire the various perspectives, contents, and methodologies, as well as comprehensive approaches from the courses.

1. Courses and Minimum Number of Credits Required for Graduation

【For students who entered from 2022】

General Studies (Zengaku Kyotsu Kamoku)

- Compulsory: 8 credits (Studies in Christian Humanism: For Others, With Others, Liberal Arts of the Body: 1 Credit, Critical Thinking & Discussion, Overview of Data Science, Thinking about Issues, Perspectives and Positionality: 2 Credits)
- Compulsory electives: 6 credits (Studies in Christian Humanism: 2 Credits, Advanced General Education Courses: 4 Credits, (including SPSF Common Core: Theme Based "Third Year Seminar for Sustainable Futures" 2 credits)
- Electives: 12 credits (including SPSF Common Core: Theme Based "First Year Lecture in/about Sustainable Futures" 4 credits)

Language

- Compulsory: 4 credits (SPSF Common Core: Academic Writing 1&2)

Specialized Education (Gakka Kamoku)

- Compulsory: 23 credits
(including SPSF Common Core: Academic Skills 2 credits)
- Electives: 71 credits

Total: 124 credits are required for graduation.

※Electives in the Specialized Education category includes both Major Electives and Electives, which are described on page 137 of the Distribution of Required credits.

【For students who entered from 2020 to 2021】

General Studies (Zengaku Kyotsu Kamoku)

- Compulsory: 2 credits (Health and Physical Education: 2 credits)
- Compulsory electives: 4 credits (Studies in Christian Humanism: 4 credits)
- Electives: 20 credits
(including SPSF Common Core: Theme Based "First Year Lecture in/about Sustainable Futures", "Third Year Seminar for Sustainable Futures (Advanced General Education course)": 6 credits)

Language

- Compulsory: 4 credits (SPSF Common Core: Academic Writing 1&2: 4 credits)

Specialized Education (Gakka Kamoku)

- Compulsory: 23 credits
(including SPSF Common Core: Academic Skills: 4 credits)
- Electives: 71 credits

Total: 124 credits are required for graduation.

※Electives in the Specialized Education category includes both Major Electives and Electives, which are described on page 138 of the Distribution of Required credits.

2. Distribution of Required Credits

Please see page 137 - 138.

3. Guidelines for Course Registration

General Information for all SPSF students

SPSF General Guidelines

- ① Information on Department of Education Specialized Education - Major Compulsory and Major Elective courses
1. Major Compulsory courses are required to be taken in the applicable year, as specified in the Distribu-

tion of Required Credits.

2. If a student earns more than the required credits for Major Elective courses, they will be regarded as Electives in the Department of Education Specialized Education category and counted as graduation credits.
 3. During the third year, students are required to take two Undergraduate Seminars in Education (1~4).
 4. During the fourth year, students are required to take Research in Education 1 in the Autumn semester and Research in Education 2 in the Spring semester.
 5. Students are required to obtain at least 8 credits by taking Special Topics in Education (1~5).
 6. If students repeat the same course offered by the Department of Education more than once, then they will only receive graduation credits for one course and any other credits will not be counted.
- ② Information on Department of Education Specialized Education – Elective courses
1. Teaching Practice (教育実習 Kyouiku-jisshuu) is not included among the Electives.
 2. Students can take a maximum of 24 credits of Specialized Education Electives taught in Japanese for graduation credits.
 3. CLIL (Content and Language Integrated Learning) courses offered in English by the Center for Language Education and Research (CLER) will not be counted for graduation credits.
- ③ Information on Department of Education Specialized Education - Bachelor's Thesis / Bachelor's Graduation Project
1. Students are required to register for the Bachelor's Thesis / Bachelor's Graduation Project (5 credits). As a general rule, this course should be taken in the Spring semester of the final academic year. In the case of students planning to graduate in March, these courses can be taken in the Autumn semester. However, in such a case, students are required to consult the Academic Advisor prior to the course registration period.
 2. Credit recognition for the Bachelor's Thesis / Bachelor's Graduation Project will depend on the evaluation of a thesis paper or a project report, and an oral examination. Instructions for the format and submission of the thesis and the report, and the procedure for the oral examination will be specified separately.
 3. The Bachelor's Thesis / Bachelor's Graduation Project is a compulsory course, but it can be cancelled (W) provided that the prescribed procedure is taken.
- ④ Information on foreign language courses
1. A total of up to 16 credits for language courses, consisting of:
 - up to 8 credits for the General Studies category; and
 - up to 8 credits for Electives in the Specialized Education category
 will be regarded as graduation credits. Students do not need to choose the same language for these courses.
- ⑤ Course Numbering
- Numbering shown in the list of assigned courses refer to the following. For information about numbering, refer to p.24.

Field (alphabets)	Field (English)
EDU	Education
GRP	Bachelor's Thesis/Bachelor's Graduation Project

4. Information on early graduation

1. Early graduation refers to an enrollment period of at least 3 years and graduating at the end of the 3rd year or at the end of the Autumn semester in the 4th year, upon completion of prescribed procedures. The former is referred to as "graduation in September of the 3rd year" and the latter "graduation in March of the 4th year".
2. In order to graduate early, all of the following requirements must be fulfilled:
 - (1) The student must express intent to graduate early.

- (2) At the time of graduation, the student must have obtained all the credits for prescribed courses necessary for graduation.
 - (3) The Grade Point Average (hereafter referred to as “the GPA”) for the total number of credits obtained must be 3.5 or more.
3. When requesting early graduation, it is necessary to apply for “early graduation registration”.
- (1) In order to apply for early graduation registration, it is necessary to obtain 80 credits or more (of which at least 62 must be obtained at Sophia University) that count toward graduation by the end of the 2nd year. In addition, the GPA for the total number of credits obtained must be at least 3.5.
 - (2) Students who register for early graduation are required to take two Undergraduate Seminars in Education (1~4) and Research in Education 1~2 (total of 8 credits), and Bachelor’s Thesis / Bachelor’s Graduation Project (5 credits) by the time they graduate.
 - Students who wish to graduate in September of the 3rd year are required to take two Undergraduate Seminars (1~4) and Research in Education 1~2 simultaneously in the 3rd year. Also, students are required to register for the Bachelor’s Thesis / Bachelor’s Graduation Project in the Spring semester in the 3rd year.
 - Students graduating in March of the 4th year are required to take two Undergraduate Seminars (1~4) and Research in Education 1~2 by the Autumn semester of the 4th year. Also, as a general rule, students are required to register for the Bachelor’s Thesis / Bachelor’s Graduation Project in the Autumn semester of the 4th year.
 - (3) A student wishing to graduate early must submit an Application for Early Graduation Registration to the Office of Department of Education during the prescribed period in September of the 2nd year. At that time, it is necessary to obtain the approval stamp of the Academic Advisor.
 - (4) A student who registers for early graduation must consult the Department Chair or the Academic Advisor in advance and receive appropriate guidance.
 - (5) A student who registers for early graduation may not, as a general rule, take a leave of absence from school.
4. The procedures to change the graduation period and withdraw early graduation registration are as follows:
- (1) In the special case of a student wishing to graduate in September of the 3rd year, it is possible to change the time of early graduation to March of the 4th year. In this case, the approval stamp of the Academic Advisor must be affixed to the Notification of Change of Early Graduation Date, and this form must be submitted to the department office during the 1Q and 2Q course registration period in the Spring semester of the 3rd year.
 - (2) If a student who has registered for early graduation wishes to withdraw the registration, the approval stamp of the Academic Advisor must be affixed to Withdrawal of Application for Early Graduation Registration, and this form must be submitted to the department office. The respective periods of submission are:
 - for withdrawal of early graduation in September of the 3rd year: 1Q and 2Q course registration period, Spring semester of the 3rd year;
 - for withdrawal of early graduation in March of the 4th year: 3Q and 4Q course registration period, Autumn semester of the 4th year.
 - (3) When withdrawing early graduation registration, courses completed in the 3rd year which would normally be taken in the 4th year will be counted for graduation.

【For students who entered from 2020 to 2021】Department of Education

○ General Studies: University-Wide General Studies (26 credits)

	1st Year		2nd Year		3rd Year		4th Year	
	Autumn Semester course title	Spring Semester course title	Autumn Semester course title	Spring Semester course title	Autumn Semester course title	Spring Semester course title	Autumn Semester course title	Spring Semester course title
Compulsory Compulsory Electives	2 cr Health and Physical Education	cr	2 cr Studies in Christian Humanism	cr				
Electives	SPSF Common Core (Theme Based)	6 cr 4	First Year Lecture in/about Sustainable Futures	4	Third Year Seminar for Sustainable Futures (Advanced General Education course)	2		
	Electives	14 cr	- General Studies Elective Courses taught in English - Language(s): up to 8 cr※1,3					

○ Language (4 credits)

	1st Year		2nd Year		3rd Year		4th Year	
	Autumn Semester course title	Spring Semester course title	Autumn Semester course title	Spring Semester course title	Autumn Semester course title	Spring Semester course title	Autumn Semester course title	Spring Semester course title
Compulsory	SPSF Common Core (Academic Skills)	4 cr 2 Academic Writing 1	2	Academic Writing 2	2			

○ Specialized Education (94 credits)

	1st Year		2nd Year		3rd Year		4th Year	
	Autumn Semester course title	Spring Semester course title	Autumn Semester course title	Spring Semester course title	Autumn Semester course title	Spring Semester course title	Autumn Semester course title	Spring Semester course title
Compulsory	Major Compulsory	19 cr Introduction to Comparative Education Comparative Education in Asia International Education Education and International Development Curriculum and Instruction	2 cr Critical Thinking & Discussion	2	2 cr Undergraduate Seminar in Education 1 Undergraduate Seminar in Education 2 Undergraduate Seminar in Education 3 Undergraduate Seminar in Education 4	2 cr Minimum 8 cr	2 cr Minimum 4 cr	5 cr Bachelor's Thesis/ Bachelor's Graduation Project Research in Education 1 Research in Education 2
Compulsory Electives	Major Electives	34 cr	SPSF Research Methods: Minimum 6 cr SPSF Fundamentals: Minimum 12 cr SPSF - SPSP Compulsory Elective(s) & Elective Course(s) - Own Department's Japanese Track Compulsory Course(s) & Compulsory Elective Course(s) & Elective Course(s) ※1, 2 - Other Faculty/Department course(s) ※1 - Course(s) for Teacher & Curator Certification with course numbers starting with 62, except "Teaching Practice 1, 2, 3 (教育実習1, 2, 3)" and "Museum Curator Field Work 1, 2 (博物館実習1, 2)" ※1 - Language(s): up to 8 cr※1, 3					

※1 No more than 24 credits of courses taught in Japanese in total.

※2 Courses offered by CLER in own Department's Japanese Track Courses are NOT included in graduation requirements.

※3 For details regarding Language courses, see p.117, "LANGUAGES (OTHER THAN ENGLISH)" and SPSF Language Courses chart.

6.Specialized Education Courses

Please refer to All SPSF Course List (p.184~p.190) of the departments which offer the courses for detailed information.

Journalism: p.184 Education: p.185 Sociology: p.186 Economics: p.187 Management:p.188 Global Studies:p.189 Other departments:p.190

Major Compulsory							
Registration CD	Course CD	Course title	Cr.	Semester offered	Instructor	Student Year	Course Offering Department
HEDS1060	147007	INTRODUCTION TO EDUCATIONAL STUDIES	2	Not Offered	MANZON Maria	1	Education
HEDS1050	147001	COMPARATIVE EDUCATION IN ASIA	2	SPR	MANZON Maria	1~2	Education
HEDS1040	147004	CURRICULUM AND INSTRUCTION	2	SPR	SAWADA, Minoru	1~2	Education
HEDS1030	147003	EDUCATION AND INTERNATIONAL DEVELOPMENT	2	AUT	KOMATSU, Taro	1~2	Education
HEDS1020	147002	INTERNATIONAL EDUCATION	2	SPR	SUGIMURA, Miki	1~2	Education
HEDS1010	147000	INTRODUCTION TO COMPARATIVE EDUCATION	2	AUT	MANZON, Maria	1~2	Education
HEDS4030	147010	BACHELOR'S THESIS / BACHELOR'S GRADUATION PROJECT	5	Not Offered	MANZON Maria	4	Education
HEDS4010	147005	RESEARCH IN EDUCATION 1	2	Not Offered	MANZON Maria	4	Education
HEDS4020	147006	RESEARCH IN EDUCATION 2	2	Not Offered	MANZON Maria	4	Education

Major Electives							
Registration CD	Course CD	Course title	Cr.	Semester offered	Instructor	Student Year	Course Offering Department
HEDS5010	147021	SPECIAL TOPICS IN EDUCATION 1: PHILOSOPHY OF EDUCATION	2	AUT	UENO, Masamichi	1~4	Education
HEDS5020	147022	SPECIAL TOPICS IN EDUCATION 2: SOCIOLOGY OF EDUCATION	2	Not Offered	AIZAWA, Shinichi	1~4	Education
HEDS5030	147023	SPECIAL TOPICS IN EDUCATION 3: CURRENT ISSUES IN EDUCATION IN ASIA	2	AUT	YAMATO, Yoko*	1~4	Education
HEDS5040	147024	SPECIAL TOPICS IN EDUCATION 4: EDUCATION FOR CRITICAL ACTION IN THE ANTHROPOCENE	2	AUT	LANGAGER Mark William*	1~4	Education
HEDS5050	147025	SPECIAL TOPICS IN EDUCATION 5: TBA	2	Not Offered	DAWSON Walter	1~4	Education

Major Electives (Seminar)							
Registration CD	Course CD	Course title	Cr.	Semester offered	Instructor	Student Year	Course Offering Department
HEDS5110	147011	UNDERGRADUATE SEMINAR IN EDUCATION 1	2	AUT	MANZON Maria	3~4	Education
HEDS5120	147012	UNDERGRADUATE SEMINAR IN EDUCATION 2	2	Not Offered	MANZON Maria	3~4	Education
HEDS5130	147013	UNDERGRADUATE SEMINAR IN EDUCATION 3	2	AUT	LANGAGER Mark William*	3~4	Education
HEDS5140	147014	UNDERGRADUATE SEMINAR IN EDUCATION 4	2	Not Offered	Staff	3~4	Education

Major Electives (SPSF Fundamentals)							
Registration CD	Course CD	Course title	Cr.	Semester offered	Instructor	Student Year	Course Offering Department
HJNS1010	268801	COMMUNICATION 1	2	AUT		1~4	Journalism
HJNS5010	268811	INTERNATIONAL COMMUNICATION 1	2	AUT		2~4	Journalism
HSCS1010	289200	PRINCIPLES OF SOCIOLOGY	2	AUT		1~4	Sociology
HSCS5030	289221	CONTEMPORARY SOCIAL PROBLEMS	2	SPR		2~4	Sociology
HSCS2010	289204	SOCIOLOGICAL THEORY 1	2	AUT		2	Sociology
HSCS2020	289205	SOCIOLOGICAL THEORY 2	2	SPR		2	Sociology
HSCS5060	289222	SOCIOLOGY OF FAMILIES	2	Not Offered		2~4	Sociology
HSCS5050	284930	SOCIOLOGY OF GLOBALIZATION	2	SPR		2~4	Sociology
HSCS5010	289220	SOCIOLOGY OF HAPPINESS	2	AUT		2~4	Sociology
EECS1002	498008	INTRODUCTION TO MACROECONOMICS	2	Not Offered		1~4	Economics
EECS1001	498007	INTRODUCTION TO MICROECONOMICS	2	AUT		1~4	Economics
EECS5020	498015	ASIAN ECONOMY	2	AUT		2~4	Economics
EECS5008	402110	CONTEMPORARY ISSUES IN INTERNATIONAL DEVELOPMENT	2	SPR		2~4	Economics
EECS5025	402080	ENVIRONMENTAL AND NATURAL RESOURCE ECONOMICS	2	SPR		2~4	Economics
EECS5007	467969	GLOBAL DEVELOPMENT GOALS	2	AUT		2~4	Economics

Registration CD	Course CD	Course title	Cr.	Semester offered	Instructor	Student Year	Course Offering Department
EECS5001	402060	INTERNATIONAL ECONOMICS AND BUSINESS	2	AUT		2~4	Economics
EECS5011	498014	POVERTY IN THE GLOBAL ECONOMY	2	2Q		2~4	Economics
EECS5019	498016	AFRICAN ECONOMY	2	Not Offered		2~4	Economics
EECS5018	498021	MATHEMATICS FOR ECONOMICS	2	AUT		2~4	Economics
EECS5031	498029	ECONOMICS OF SOCIAL POLICY	2	AUT		2~4	Economics
EMGS5001	468058	PRINCIPLES OF ACCOUNTING	2	AUT		1~4	Management
EMGS5032	468033	PRINCIPLES OF MANAGEMENT	2	AUT		1~4	Management
EMGS5047	468039	PRINCIPLES OF MARKETING	2	AUT		1~4	Management
BGSS1010	BGSS1010	INTRODUCTION TO GLOBAL STUDIES	2	AUT		1~4	Global Studies
BGSS1020	BGSS1020	INTRODUCTION TO INTERNATIONAL RELATIONS	2	AUT		1~4	Global Studies
BGSS1030	BGSS1030	INTRODUCTION TO AREA STUDIES	2	AUT		1~4	Global Studies
BGSS3001	BGS59700	INTERNATIONAL POLITICS: THEORY AND PRACTICE	2	AUT		2~4	Global Studies
BGSS3002	BGS59800	INTERNATIONAL ORGANIZATION: THEORY AND PRACTICE	2	SPR		2~4	Global Studies
BGSS3003	BGS20000	BASICS OF INTERNATIONAL COOPERATION B	2	SPR		2~4	Global Studies
BGSS3004	BGS20001	BASICS OF SOUTHEAST ASIAN STUDIES B	2	SPR		2~4	Global Studies

Major Electives (SPSF Research Methods)

Registration CD	Course CD	Course title	Cr.	Semester offered	Instructor	Student Year	Course Offering Department
HSCS1030	289202	QUANTITATIVE METHODS IN SOCIOLOGY	2	SPR		1~4	Sociology
HSCS2030	289203	QUALITATIVE METHODS IN SOCIOLOGY	2	AUT		2~4	Sociology
EECS1003	498017	INTRODUCTION TO STATISTICS	2	SPR		1~4	Economics
EECS1004	498009	INTRODUCTION TO DATA ANALYSIS	2	AUT		2~4	Economics

Electives

Registration CD	Course CD	Course title	Cr.	Semester offered	Instructor	Student Year	Course Offering Department
HJNS5020	268812	INTERNATIONAL COMMUNICATION 2	2	Not Offered		2~4	Journalism
HJNS5030	268813	MASS MEDIA 1	2	Not Offered		3~4	Journalism
HJNS5040	268814	MASS MEDIA 2	2	Not Offered		3~4	Journalism
HJNS5070	268817	REPORTING IN ENGLISH 1	2	Not Offered		3~4	Journalism
HJNS5080	268818	REPORTING IN ENGLISH 2	2	Not Offered		3~4	Journalism
HJNS5090	268819	REPORTING IN ENGLISH 3	2	Not Offered		3~4	Journalism
HJNS5050	268815	ETHICS OF MASS COMMUNICATION 1	2	Not Offered		3~4	Journalism
HJNS5060	268816	ETHICS OF MASS COMMUNICATION 2	2	Not Offered		3~4	Journalism
HSCS5040	288807	SOCIAL CHANGE IN POSTWAR JAPAN	2	Not Offered		2~4	Sociology
HSCS5020	288893	WORK AND EMPLOYMENT IN JAPAN	2	AUT		2~4	Sociology
HSCS5130	289226	ENVIRONMENTAL SOCIOLOGY	2	Not Offered		3~4	Sociology
HSCS5110	289224	SPECIAL TOPICS IN SOCIOLOGY 1	2	1Q		3~4	Sociology
HSCS5120	289225	SPECIAL TOPICS IN SOCIOLOGY 2	2	AUT		3~4	Sociology
EECS5026	402100	GAME THEORY	2	AUT		2~4	Economics
EECS5005	402090	GLOBAL ECONOMIC HISTORY	2	Not Offered		2~4	Economics
EECS5024	498010	INTERNATIONAL FINANCE	2	SPR		2~4	Economics
EECS5004	402120	JAPANESE ECONOMY 1	2	SPR		2~4	Economics
EECS5002	498024	PUBLIC ECONOMICS 1	2	SPR		2~4	Economics
EECS5028	498026	ACTIVE LEARNING SEMINAR 1	2	SPR		3~4	Economics
EECS5029	498027	ACTIVE LEARNING SEMINAR 2	2	AUT		3~4	Economics
EECS5030	498028	QUANTITATIVE ANALYSIS OF SOCIAL ISSUES	2	SPR		2~4	Economics
EMGS5044	468036	CONSUMER BEHAVIOR 1	2	SPR		2~4	Management
EMGS5045	468037	CONSUMER BEHAVIOR 2	2	AUT		2~4	Management
EMGS5052	468069	ENTREPRENEURSHIP 1	2	SPR		2~4	Management
EMGS5053	468070	ENTREPRENEURSHIP 2	2	AUT		2~4	Management

Registration CD	Course CD	Course title	Cr.	Semester offered	Instructor	Student Year	Course Offering Department
EMGS5004	468059	FINANCIAL ACCOUNTING 1	2	SPR		2~4	Management
EMGS5005	468060	FINANCIAL ACCOUNTING 2	2	AUT		2~4	Management
EMGS5041	468050	FUNDAMENTALS OF ACCOUNTING 1	2	Not Offered		2~4	Management
EMGS5042	468051	FUNDAMENTALS OF ACCOUNTING 2	2	AUT		2~4	Management
EMGS5050	468048	GLOBAL MARKETING 1	2	Not Offered		2~4	Management
EMGS5051	468049	GLOBAL MARKETING 2	2	1Q		2~4	Management
EMGS5054	468071	INNOVATION MANAGEMENT	2	Not Offered		2~4	Management
EMGS5039	468034	MANAGEMENT ACCOUNTING 1	2	Not Offered		2~4	Management
EMGS5040	468035	MANAGEMENT ACCOUNTING 2	2	Not Offered		2~4	Management
EMGS5048	468040	MARKETING STRATEGY 1	2	SPR		2~4	Management
EMGS5049	468041	MARKETING STRATEGY 2	2	AUT		2~4	Management
EMGS5035	468046	ORGANIZATIONAL BEHAVIOR	2	Not Offered		2~4	Management
EMGS5036	468047	ORGANIZATIONAL THEORY AND ANALYSIS	2	AUT		2~4	Management
EMGS5037	468052	STRATEGIC MANAGEMENT	2	SPR		2~4	Management
EMGS5038	468068	CHALLENGING FRONTLINE ISSUES IN GLOBAL BUSINESS	4	SPR		3~4	Management
EMGS5043	408010	GLOBAL BRANDING	2	AUT		3~4	Management
EMGS5027	468062	INTERNATIONAL ACCOUNTING	2	SPR		3~4	Management
EMGS5033	468044	SPECIAL TOPICS IN MANAGEMENT 1	2	AUT		3~4	Management
EMGS5034	468045	SPECIAL TOPICS IN MANAGEMENT 2	2	SPR		3~4	Management
EMGS5046	468038	SPECIAL TOPICS IN MARKETING	2	2Q		2~4	Management
BGSS3000	BGS50201	GLOBALIZATION AND ECONOMICS 2	2	AUT		2~4	Global Studies
BGSS3011	BGS20004	AFRICA'S DEVELOPMENT AID	2	AUT		3~4	Global Studies
BGSS3012	BGS20005	ANTHROPOLOGY OF SUFFERINGS AND HOPES IN AFRICA	2	AUT		3~4	Global Studies
BGSS3016	BGS59500	ASIAN POLITICS	2	SPR		3~4	Global Studies
BGSS3014	BGS20007	CONFLICT RESOLUTION B	2	AUT		2~4	Global Studies
BGSS3008	BGS58300	CONTEMPORARY SOCIETIES OF THE MIDDLE EAST	2	AUT		3~4	Global Studies
BGSS3006	BGS20002	EDUCATION FOR MINORITIES IN JAPAN	2	AUT		3~4	Global Studies
BGSS3010	BGS58100	LIFE AND CULTURE IN AFRICA	2	AUT		3~4	Global Studies
BGSS3015	BGS59000	PEACE RESEARCH	2	SPR		3~4	Global Studies
BGSS3017	BGS20008	MODERN HISTORY OF THE MIDDLE EAST B	2	AUT		3~4	Global Studies
BGSS3007	BGS57900	SOCIETY AND POLITICS IN SOUTH ASIA	2	AUT		3~4	Global Studies
BGSS3005	BGS58500	THEORY OF INTERNATIONAL POLITICS	2	AUT		3~4	Global Studies
BGSS4005	BGS57507	ADVANCED STUDIES (CONTEMPORARY SOCIETIES OF ASIA)	2	SPR		3~4	Global Studies
BGSS4004	BGS57508	ADVANCED STUDIES (CULTURES AND SOCIETIES OF ASIA)	2	SPR		3~4	Global Studies
BGSS4002	BGS25000	ADVANCED STUDIES (DEMOCRACY AND CONFLICT)	2	SPR		3~4	Global Studies
BGSS4006	BGS57517	ADVANCED STUDIES (GLOBAL MIGRATION AND KOREANS IN JAPAN)	2	AUT		3~4	Global Studies
BGSS4001	BGS57516	ADVANCED STUDIES (INTERNATIONAL HUMAN RIGHTS)	2	SPR		3~4	Global Studies
BGSS4003	BGS57505	ADVANCED STUDIES (INTERNATIONAL ORGANIZATION B)	2	SPR		3~4	Global Studies

Department of Sociology SPSF Curriculum

Education and Research Objectives

To cultivate critical interest in human society, and the capacity to comprehend the mechanisms of social phenomena through the use of sociological approaches and empirical analysis.

Human Resource Development Objectives

To produce graduates equipped with sociological insights and methodological knowledge who are capable of employing an international outlook and humanitarian approach in proposing problem-solving solutions in practical settings.

Diploma Policy

With an aim to foster individuals with the following qualities to achieve a fair and equitable society that protects human dignity, the Department of Sociology sets the following standards for the skills and knowledge students should acquire before graduation. Those who fulfill the graduation requirements shall be deemed to have acquired these qualities and will be awarded a diploma.

1. An interest in various social issues and the ability to understand social phenomena through a sociological approach.
2. The ability to understand and analyze the mechanisms of social phenomena using basic theories and empirical methods.
3. The ability to understand the characteristics of the various dimensions of modern society as they relate to social structure and social change.
4. The ability to understand diverse others and to propose sociologically-informed solutions for creating an inclusive society.

In addition to the above, the SPSF course sets the following abilities which students should acquire before graduation as common requirements across its six departments (Department of Journalism, Department of Education, Department of Sociology, Department of Economics, Department of Management, Department of Global Studies).

5. The ability to acquire the basic knowledge on “Sustainable Futures” necessary to understand its importance, and to take action towards resolving challenges to the sustainable futures by drawing upon knowledge from their own academic discipline as well as from the other five disciplines in the SPSF course.
6. The ability to understand and apply the interdisciplinary perspectives and methodologies, which they studied in their own academic discipline and in the other five disciplines of the SPSF course, when addressing issues and presenting their ideas.

Curriculum Policy

In accordance with the Diploma Policy, the Department of Sociology’s curriculum consists of courses aligned with the following objectives.

1. Through small-group seminars, have students acquire basic sociological perspectives and knowledge of methodologies necessary for developing sociological research interests.
2. With regard to “theory and methods” as the basic tools of sociological analysis, have students acquire, through exposure to sociological theories, logical thinking skills and the ability to conceptualize a research interest and model its research design; and through quantitative or qualitative research skills acquired through courses in social survey methods, the ability to analyze social phenomena.
3. Teach students to apply the theoretical and methodological knowledge acquired to specific areas of modern society to deepen their understanding of the structure(s) and change(s) within such areas.
4. Foster the ability to develop research questions based on individual concerns, while maintaining a global outlook that respects human dignity, perform sophisticated analyses and engage in critical discussions.

In addition to the above, the SPSF course constructs its curriculum in the following manner, for the purpose of achieving the common diploma policy across the six departments:

5. Enable the students during the first year to acquire a basic knowledge on “Sustainable Futures” and the related issues through the SPSF General Studies Courses, drawing on the perspectives of six disciplines. Based on the

acquired knowledge, the students will be able to deepen their understanding of various challenges related to the sustainable futures through Elective Courses in the University-wide General Studies Courses. They will also be able to learn about the approaches, contents, and methodologies of the different disciplines through Specialized Courses offered by each department.

6. Enable students to gradually gain knowledge in the different disciplines of each Department and also acquire broader knowledge through the courses offered by other faculties and departments which have been designated to offer Elective Compulsory Courses or Elective Courses. Thus, students will be able to acquire the various perspectives, contents, and methodologies, as well as comprehensive approaches offered in the different courses.

1. Courses and Minimum Number of Credits Required for Graduation

【For students who entered from 2022】

General Studies (Zengaku Kyotsu Kamoku)

Compulsory:	8 credits (Studies in Christian Humanism: For Others, With Others, Liberal Arts of the Body: 1 Credit, Critical Thinking & Discussion, Overview of Data Science, Thinking about Issues, Perspectives and Positionality: 2 Credits)
Compulsory electives:	6 credits (Studies in Christian Humanism: 2 Credits, Advanced General Education Courses: 4 Credits (including SPSF Common Core: Theme Based "Third Year Seminar for Sustainable Futures" 2 credits)
Electives:	12 credits (including SPSF Common Core: Theme Based "First Year Lecture in/about Sustainable Futures" 4 credits)

Language

Compulsory:	4 credits (SPSF Common Core: Academic Writing 1 & 2)
-------------	--

Specialized Education (Gakka Kamoku)

Compulsory:	22 credits
Electives:	72 credits (including SPSF Common Core: Academic Skills: 2 credits, Major Core Category 2: 28 credits)

Total: 124 credits are required for graduation.

【For students who entered from 2020 to 2021】

General Studies (Zengaku Kyotsu Kamoku)

Compulsory:	2 credits (Health and Physical Education: 2 credits)
Compulsory electives:	4 credits (Studies in Christian Humanism)
Electives:	20 credits (including SPSF Common Core: Theme Based "First Year Lecture in/about Sustainable Futures", "Third Year Seminar for Sustainable Futures (Advanced General Education course)" 6 credits)

Language

Compulsory:	4 credits (SPSF Common Core: Academic Writing 1&2)
-------------	--

Specialized Education (Gakka Kamoku)

Compulsory:	22 credits
Electives:	72 credits (including SPSF Common Core: Academic Skills: 4 credits, Major Core Category 2: 26 credits)

Total: 124 credits are required for graduation.

2. Distribution of Required Credits

Please see page 147 - 148

3. Guidelines for Course Registration

① Language Courses

- (1) Academic Writing 1 & 2 are Compulsory Courses for 1st year students.

② SPSF Common Core (Academic Skills) Courses

- (1) Critical Thinking & Discussion and Academic Presentation are Compulsory Courses for 1st year students.

③ Major Courses in Sociology (listed as “Specialized Education” courses in the SPSF Bulletin)

Major Core Category 1: Compulsory Courses

- (1) Principles of Sociology, First Year Seminar in Sociology, and Quantitative Methods in Sociology are Compulsory Courses for 1st year students.
- (2) Sociological Theory 1 & 2, Qualitative Methods in Sociology, and Introduction to Statistics are Compulsory Courses for 2nd year students.
- (3) Advanced Seminar in Sociology is a Compulsory Course to be taken every semester by 3rd and 4th year students (total of 8 credits).
- (4) Students who wish to deepen their understanding of Sociological Theory and Methodology and who possess sufficient Japanese ability can take Sociological Theory I & II (社会学理論I&II) and Social Research Methods I & II (社会調査方法論I&II) as SE elective courses (held as part of the Sociology Department’s Japanese track course curriculum) provided that they notify their Academic Advisor and receive permission. These credits will be included in the maximum number of 24 credits that a student can obtain through courses taught in Japanese.

Major Core Category 2: Compulsory Elective Courses

- (1) SPSF Students are advised to prioritize taking Sociology courses held as part of the English track course curriculum in the Department of Sociology. The SPSF curriculum is designed so that the Department of Sociology’s Category 2 compulsory elective course credit requirement can be fulfilled through the Category 2 compulsory elective courses specified in the English track course curriculum. Because some Category 2 compulsory elective courses are not held every year, students should take note of the course numbering and carefully plan their course enrollment accordingly. Moreover, students who have sufficient Japanese ability to take the Compulsory Elective Courses in the Japanese track course curriculum (refer to the Japanese track course curriculum Academic Handbook) may do so and appropriate up to 10 credits to their Category 2 Compulsory Elective Courses requirement. These credits will be included in the maximum number of 24 credits that a student can obtain through courses taught in Japanese.
- (2) If the number of Category 2 Compulsory Elective Courses credits obtained exceeds 26 credits, the excess credits may be assigned as SE Electives for the purpose of graduation.

SE Electives

- (1) Credits from the SE elective courses specified in the English track course curriculum of the Department of Sociology may be appropriated for SE elective credits.
- (2) A maximum of 24 credits for compulsory elective and elective courses offered in the Japanese track course curriculum in the Department of Sociology can be appropriated for SE electives. However, when appropriating compulsory elective courses in the Japanese track course curriculum as graduation credits for Category 2 compulsory elective courses, those credits will be deducted from the maximum 24 credits that may be appropriated for SE electives.
- (3) If the research topic of a student coincides with that of Seminars (held as part of the Japanese track course curriculum in the Department of Sociology), and the Japanese ability of the student is sufficient to take the course, it is possible to appropriate up to 8 credits from the Japanese track course curriculum seminar for SE electives, provided that in January of the Autumn Semester of the student’s 2nd or 3rd year, the student notifies, and upon an interview with their Academic Advisor, receives permission from the department. These credits will be included in the maximum number of 24 credits that a student can obtain through courses taught in Japanese.
- (4) Credits for SE electives can be appropriated as credits for (1) Courses for Teacher & Curator Certification with course numbers starting with 62 (except “Teaching Practice 1, 2, 3 [教育実習] and “Museum Curator Field Work 1, 2 [博物館実習 1, 2]); (2) Language courses taught in English (Japanese, Chinese, French,

and Spanish; maximum 8 credits); and (3) General Studies courses taught in English (except “Compulsory [HPE]” and “Electives [Sports Practice courses]”; however, up to 12 credits may be appropriated as graduation credits).

④ General Studies

- (1) Please refer to p.108 of the Bulletin of Information regarding foreign languages in General Studies.

⑤ Bachelor’s Thesis

- (1) Students who wish to enter graduate school are advised to prepare and submit a bachelor’s thesis.
- (2) As a general rule, students are required to register for the “Bachelor’s Thesis” course (6 credits) held during the Spring Semester of their 4th year. However, students who expect to graduate in March may take this course during the Autumn Semester. When registering for the Autumn Semester, it is necessary to go to the Center for Academic Affairs counter during the course registration period.
- (3) Concerning the title of the bachelor’s thesis and the instructor a student would like to have as supervisor, it is necessary to submit a Bachelor’s Thesis Pre-registration Form to the Academic Advisor of the Department of Sociology at the Office of Human Sciences by the end of April in the 4th year (or end of October in the 4th year, in case of graduation in March).
- (4) The bachelor’s thesis must be written or typed from left to right on A4-sized paper, and must consist of at least 10,000 words. There are no rules on the number of lines per page or the length of each line.
- (5) Submission procedure
- Period/time To be posted on the Faculty and Department Office’s Loyola Bulletin Board
 - Place To be posted on the Faculty and Department Office’s Loyola Bulletin Board

⑥ Order for Taking Courses

As a general rule, as shown in the [Course 1] [Course 2] example below, Course 2 should be taken after completion of Course 1. In unavoidable circumstances, if students wish to take Course 2 before taking Course 1, it is necessary to obtain permission from their Academic Advisor. However, depending on the course or circumstance, this may not be possible.

[Course 1]	→	[Course 2]
Principles of Sociology	→	First Year Seminar in Sociology
Sociological Theory 1	→	Sociological Theory 2
Quantitative Methods in Sociology	→	Introduction to Statistics

⑦ Course Numbering

The numbering shown in the list of assigned courses refers to the following. For information about numbering, refer to p.24.

Field (alphabet)	Field (English)	Field (Japanese)
SOC	Sociology	社会学
GRP	Graduation Project	卒業論文

4. Early Graduation

- ① Early graduation refers to an enrollment period of at least 3 years and graduating at the end of the 3rd year or at the end of the Autumn Semester in the 4th year, upon the completion of prescribed requirements and procedures. The former is referred to as “graduation in September of the 3rd year” and the latter as “graduation in March of the 4th year.”
- ② In order to graduate early, all of the following requirements must be fulfilled.
- The student must wish to graduate early.
 - At the time of graduation, the student must have obtained all of the credits for the prescribed courses that are necessary for graduation.

- (3) The Grade Point Average (hereinafter referred to as “GPA”) for the total number of credits obtained must be 3.5 or higher.
- ③ When wishing to graduate early, it is necessary to register for early graduation.
- (1) In order to register for early graduation, it is necessary to obtain 80 credits or more (of which at least 62 must be obtained at Sophia University) that count toward graduation in prescribed courses by the end of the 2nd year. In addition, the GPA for the total number of credits obtained must be at least 3.2.
 - (2) A student who registers for early graduation must have taken the Advanced Seminar in Sociology (total of 8 credits) sequence by the time of graduation. A student wishing to graduate in September of the 3rd year must take 2 courses (4 credits) within the Advanced Seminar in Sociology sequence in the student’s 3rd year. Additionally, the student may apply up to 4 credits from the Japanese track course curriculum Seminars (students who do not possess sufficient Japanese ability must consult with their Academic Advisor upon selecting a seminar) to the credits earned from the Advanced Seminar in Sociology to achieve a total of 8 credits, provided that in January of the Autumn Semester of the student’s 2nd year, the student notifies, and upon an interview with their Academic Advisor, receives permission from the department. A student wishing to graduate in March of the 4th year must, as a general rule, take the Advanced Seminar in Sociology an overall of three times during the Autumn and Spring Semester of the 3rd year, and in the Autumn Semester of the 4th year. Additionally, during these three semesters, the student may apply up to 2 credits from the Japanese track course curriculum Seminars (students who do not possess sufficient Japanese ability must consult their Academic Advisor upon selecting a seminar) to the credits earned from the Advanced Seminar in Sociology to achieve a total of 8 credits, provided that the student notifies, and upon an interview with their Academic Advisor, receives permission from the department before the registration period of each semester.
 - (3) A student wishing to graduate early must submit an Application for Early Graduation Registration to the department office during the prescribed period in September of the 2nd year. At that time, it is necessary to obtain the signature or approval stamp of the instructor in charge of the seminars the student will be attending in the 3rd year.
 - (4) A student who registers for early graduation must consult their Academic Advisor in advance and receive appropriate guidance. Also, the student must report the progress of their studies to the instructor in charge of the seminar and receive guidance as required.
 - (5) When a student registers for early graduation, as a general rule, they must not be on a leave of absence from school.
- ④ Changes to one’s graduation date and withdrawal of early graduation registration will be carried out as follows:
- (1) In the special case of a student wishing to graduate in September of the 3rd year, it is possible to change the time of early graduation to March of the 4th year. In this case, the approval stamp of the Department Chair must be affixed to the Notification of Change of Early Graduation Date, and this form must be submitted to the department office during the 1Q and 2Q course registration period in the Spring Semester of the 3rd year.
 - (2) If a student who has registered for early graduation wishes to withdraw their early graduation registration, the approval stamp of the Department Chair must be affixed to the Withdrawal of Application for Early Graduation Registration, and this form must be submitted to the department office. The period of submission for withdrawal of early graduation in September of the 3rd year is during the 1Q and 2Q course registration period in the Spring Semester of the 3rd year, and for withdrawal of early graduation in March of the 4th year, it is during the 3Q and 4Q course registration period in the Autumn Semester of the 4th year.
 - (3) When withdrawing one’s early graduation application, courses completed in the 3rd year which would normally be taken in the 4th year will be included in the credits necessary for graduation. In this case, credits obtained in excess of 8 credits will be included in the elective required courses of the department.
 - (4) If a student withdraws their early graduation request for September of the 3rd year or March of the 4th year, it will be necessary to take the Advanced Seminar in Sociology courses in each of the semesters in the 4th year. In this case, seminars taken in the 4th year must be selected from seminars conducted by the instructor in charge during the 3rd year.
 - (5) When a student graduating in September of the 3rd year or March of the 4th year submits a bachelor’s thesis, it is necessary to register for the Bachelor’s Thesis course in the final semester of enrollment and submit the thesis by the deadline specified by the department. It is necessary to receive guidance from an instructor in charge of the seminar when writing a bachelor’s thesis.

5. Distribution of Required Credits

【For students who entered from 2022】Department of Sociology

○ General Studies: University-Wide General Studies (26 credits)

	1st Year		2nd Year		3rd Year		4th Year	
	Autumn Semester course title	Spring Semester course title	Autumn Semester course title	Spring Semester course title	Autumn Semester course title	Spring Semester course title	Autumn Semester course title	Spring Semester course title
Compulsory	8 cr							
	Studies in Christian Humanism: For Others, With Others	Critical Thinking & Discussion						
	Liberal Arts of the Body	Overview of Data Science						
	Thinking about Issues, Perspectives and Positionality							
Compulsory Electives	6 cr							
	Studies in Christian Humanism		2					
	Advanced General Education Courses							
	SPSF Common Core(Theme Based)							
	SPSF Common Core(Theme Based)				Third Year Seminar for Sustainable Futures	2		
Electives	12cr							
	First Year Lecture in/about Sustainable Futures		4					
	General Studies Elective Courses taught in English							
	First-year students may take General Studies Elective Courses up to 4 credits each semester							
	Language(s): up to 8 cr※1,3							
	Credits earned in excess of 6 credits in Compulsory Electives will be counted into Electives.							

○ Language (4 credits)

	1st Year		2nd Year		3rd Year		4th Year	
	Autumn Semester course title	Spring Semester course title	Autumn Semester course title	Spring Semester course title	Autumn Semester course title	Spring Semester course title	Autumn Semester course title	Spring Semester course title
Compulsory	4 cr							
	SPSF Common Core (Academic Skills)	Academic Writing 1	2	Academic Writing 2	2			

○ Specialized Education (94 credits)

	1st Year		2nd Year		3rd Year		4th Year	
	Autumn Semester course title	Spring Semester course title	Autumn Semester course title	Spring Semester course title	Autumn Semester course title	Spring Semester course title	Autumn Semester course title	Spring Semester course title
Compulsory	22 cr							
	Principles of Sociology	First Year Seminar in Sociology	2	Sociological Theory 1	2	Advanced Seminar in Sociology	2	Advanced Seminar in Sociology
	Quantitative Methods in Sociology	Quantitative Methods in Sociology	2	Qualitative Methods in Sociology	2	Introduction to Statistics	2	
Compulsory Electives	2 cr							
	Academic Presentations		2					
	Major Core Category 2							
	SE Electives							
Electives	44cr							
	Major Core Category 2							
	SE Electives							

Course(s) taught in Japanese: Own Department's Compulsory Elective Course(s) only, up to 10 cr※1

※1 Major Core Category 2 (The excess credits of Major Core Category 2)

– Other Faculty/Department Course(s)※1

– Course(s) for Teacher & Curator Certification with course numbers starting with 62, except "Teaching Practice 1, 2, 3 (教育実習1, 2, 3)" and "Museum Curator Field Work 1, 2 (博物館実習1, 2)"※1

– Own Department's Japanese Track the excess credits of Compulsory Elective and Elective course(s)※1,2

– Language(s): Course(s) taught in English (Japanese, Chinese, French, Spanish) : up to 8 cr ※3

– General Studies Course(s) taught in English except "Compulsory" and "Electives(Sports Practice courses)": up to 12 cr

※1 No more than 24 credits of courses taught in Japanese in total.

※2 No Constraints: Language Courses offered by CLER in own Department's Japanese Track Elective courses are not included in graduation requirements.

※3 For details regarding Language courses, see p.117. "LANGUAGES (OTHER THAN ENGLISH)" and SPSF Language Courses chart.

6.Specialized Education Courses

Please refer to All SPSF Course List (p.184~p.190) of the departments which offer the courses for detailed information.

Journalism: p.184 Education: p.185 Sociology: p.186 Economics: p.187 Management:p.188 Global Studies:p.189 Other departments:p.190

Major Core Category 1							
Registration CD	Course CD	Course title	Cr.	Semester offered	Instructor	Student Year	Course Offering Department
HSCS1020	289201	FIRST YEAR SEMINAR IN SOCIOLOGY	2	SPR	HOMMERICH, Carola	1	Sociology
HSCS1010	289200	PRINCIPLES OF SOCIOLOGY	2	AUT	HOMMERICH, Carola	1	Sociology
HSCS1030	289202	QUANTITATIVE METHODS IN SOCIOLOGY	2	SPR	HOMMERICH, Carola	1	Sociology
HSCS2030	289203	QUALITATIVE METHODS IN SOCIOLOGY	2	AUT	SPODEN, Celia*	2	Sociology
HSCS2010	289204	SOCIOLOGICAL THEORY 1	2	AUT	HOMMERICH, Carola	2	Sociology
HSCS2020	289205	SOCIOLOGICAL THEORY 2	2	SPR	HOMMERICH, Carola	2	Sociology
HSCS3010	289211	ADVANCED SEMINAR IN SOCIOLOGY	2	Aut	HOMMERICH, Carola	3~4	Sociology
HSCS3020	289211	ADVANCED SEMINAR IN SOCIOLOGY	2	Not Offered	HOMMERICH, Carola	3~4	Sociology
EECS1003	498017	INTRODUCTION TO STATISTICS	2	SPR		2	Economics

Major Core Category 2							
Registration CD	Course CD	Course title	Cr.	Semester offered	Instructor	Student Year	Course Offering Department
HSCS5030	289221	CONTEMPORARY SOCIAL PROBLEMS	2	SPR	KOTTMANN, Nora*	2~4	Sociology
HSCS5040	288807	SOCIAL CHANGE IN POSTWAR JAPAN	2	Not Offered	SARUYA, Hiroe	2~4	Sociology
HSCS5060	289222	SOCIOLOGY OF FAMILIES	2	Not Offered	TABUCHI, Rokuro	2~4	Sociology
HSCS5050	284930	SOCIOLOGY OF GLOBALIZATION	2	SPR	HOSOKI, Ittonen Ralph	2~4	Sociology
HSCS5010	289220	SOCIOLOGY OF HAPPINESS	2	AUT	HOMMERICH, Carola	2~4	Sociology
HSCS5020	288893	WORK AND EMPLOYMENT IN JAPAN	2	AUT	IMAL, Jun	2~4	Sociology
HSCS5130	289226	ENVIRONMENTAL SOCIOLOGY	2	Not Offered	Staff	3~4	Sociology
HSCS5110	289224	SPECIAL TOPICS IN SOCIOLOGY 1	2	1Q	GANSEFORTH, Sonja*	3~4	Sociology
HSCS5120	289225	SPECIAL TOPICS IN SOCIOLOGY 2	2	AUT	TAKENOSHITA, Hirohisa*	3~4	Sociology
HSCS5200	289210	BACHELOR'S THESIS	6	Not Offered	Supervisor	4	Sociology
HJNS1010	268801	COMMUNICATION 1	2	AUT		1~4	Journalism
HJNS5010	268811	INTERNATIONAL COMMUNICATION 1	2	AUT		2~4	Journalism
HJNS5030	268813	MASS MEDIA 1	2	Not Offered		3~4	Journalism
HJNS5050	268815	ETHICS OF MASS COMMUNICATION 1	2	Not Offered		3~4	Journalism
HEDS1010	147000	INTRODUCTION TO COMPARATIVE EDUCATION	2	AUT		2~4	Education
HEDS5020	147022	SPECIAL TOPICS IN EDUCATION 2: SOCIOLOGY OF EDUCATION	2	Not Offered		2~4	Education
EECS1002	498008	INTRODUCTION TO MACROECONOMICS	2	Not Offered		1~4	Economics
EECS1001	498007	INTRODUCTION TO MICROECONOMICS	2	AUT		1~4	Economics
EECS1004	498009	INTRODUCTION TO DATA ANALYSIS	2	AUT		2~4	Economics
EMGS5001	468058	PRINCIPLES OF ACCOUNTING	2	AUT		1~4	Management
EMGS5032	468033	PRINCIPLES OF MANAGEMENT	2	AUT		1~4	Management
EMGS5047	468039	PRINCIPLES OF MARKETING	2	AUT		1~4	Management
EMGS5044	468036	CONSUMER BEHAVIOR 1	2	SPR		2~4	Management
EMGS5035	468046	ORGANIZATIONAL BEHAVIOR	2	Not Offered		2~4	Management
EMGS5037	468052	STRATEGIC MANAGEMENT	2	SPR		2~4	Management
EMGS5038	468068	CHALLENGING FRONTLINE ISSUES IN GLOBAL BUSINESS	4	SPR		3~4	Management
BGSS1030	BGSS1030	INTRODUCTION TO AREA STUDIES	2	AUT		1~4	Global Studies

Registration CD	Course CD	Course title	Cr.	Semester offered	Instructor	Student Year	Course Offering Department
BGSS1010	BGSS1010	INTRODUCTION TO GLOBAL STUDIES	2	AUT		1~4	Global Studies
BGSS1020	BGSS1020	INTRODUCTION TO INTERNATIONAL RELATIONS	2	AUT		1~4	Global Studies
BGSS3004	BGS20001	BASICS OF SOUTHEAST ASIAN STUDIES B	2	SPR		2~4	Global Studies
ASOC3090	SOC309	FOOD AND SOCIETY	4	SPR		3~4	FLA

SE Electives

Registration CD	Course CD	Course title	Cr.	Semester offered	Instructor	Student Year	Course Offering Department
HJNS5020	268812	INTERNATIONAL COMMUNICATION 2	2	Not Offered		2~4	Journalism
HEDS5040	147024	SPECIAL TOPICS IN EDUCATION 4: EDUCATION FOR CRITICAL ACTION IN THE ANTHROPOCENE	2	AUT		2~4	Education
HEDS5050	147025	SPECIAL TOPICS IN EDUCATION 5: TBA	2	Not Offered		2~4	Education
HJNS5040	268814	MASS MEDIA 2	2	Not Offered		3~4	Journalism
HJNS5070	268817	REPORTING IN ENGLISH 1	2	Not Offered		3~4	Journalism
HJNS5080	268818	REPORTING IN ENGLISH 2	2	Not Offered		3~4	Journalism
HJNS5090	268819	REPORTING IN ENGLISH 3	2	Not Offered		3~4	Journalism
HJNS5060	268816	ETHICS OF MASS COMMUNICATION 2	2	Not Offered		3~4	Journalism
HEDS1050	147001	COMPARATIVE EDUCATION IN ASIA	2	SPR		2~4	Education
HEDS1040	147004	CURRICULUM AND INSTRUCTION	2	SPR		2~4	Education
HEDS1030	147003	EDUCATION AND INTERNATIONAL DEVELOPMENT	2	AUT		2~4	Education
HEDS1020	147002	INTERNATIONAL EDUCATION	2	SPR		2~4	Education
HEDS5010	147021	SPECIAL TOPICS IN EDUCATION 1: PHILOSOPHY OF EDUCATION	2	AUT		2~4	Education
HEDS5030	147023	SPECIAL TOPICS IN EDUCATION 3: CURRENT ISSUES IN EDUCATION IN ASIA	2	AUT		2~4	Education
EECS5019	498016	AFRICAN ECONOMY	2	Not Offered		2~4	Economics
EECS5020	498015	ASIAN ECONOMY	2	AUT		2~4	Economics
EECS5008	402110	CONTEMPORARY ISSUES IN INTERNATIONAL DEVELOPMENT	2	SPR		2~4	Economics
EECS5025	402080	ENVIRONMENTAL AND NATURAL RESOURCE ECONOMICS	2	SPR		2~4	Economics
EECS5026	402100	GAME THEORY	2	AUT		2~4	Economics
EECS5007	467969	GLOBAL DEVELOPMENT GOALS	2	AUT		2~4	Economics
EECS5005	402090	GLOBAL ECONOMIC HISTORY	2	Not Offered		2~4	Economics
EECS5001	402060	INTERNATIONAL ECONOMICS AND BUSINESS	2	AUT		2~4	Economics
EECS5024	498010	INTERNATIONAL FINANCE	2	SPR		2~4	Economics
EECS5004	402120	JAPANESE ECONOMY 1	2	SPR		2~4	Economics
EECS5011	498014	POVERTY IN THE GLOBAL ECONOMY	2	2Q		2~4	Economics
EECS5002	498024	PUBLIC ECONOMICS 1	2	SPR		2~4	Economics
EECS5028	498026	ACTIVE LEARNING SEMINAR 1	2	SPR		2~4	Economics
EECS5029	498027	ACTIVE LEARNING SEMINAR 2	2	AUT		3~4	Economics
EECS5030	498028	QUANTITATIVE ANALYSIS OF SOCIAL ISSUES	2	SPR		2~4	Economics
EECS5031	498029	ECONOMICS OF SOCIAL POLICY	2	AUT		2~4	Economics
EMGS5045	468037	CONSUMER BEHAVIOR 2	2	AUT		2~4	Management
EMGS5052	468069	ENTREPRENEURSHIP 1	2	SPR		2~4	Management
EMGS5053	468070	ENTREPRENEURSHIP 2	2	AUT		2~4	Management
EMGS5004	468059	FINANCIAL ACCOUNTING 1	2	SPR		2~4	Management
EMGS5005	468060	FINANCIAL ACCOUNTING 2	2	AUT		2~4	Management
EMGS5041	468050	FUNDAMENTALS OF ACCOUNTING 1	2	Not Offered		2~4	Management
EMGS5042	468051	FUNDAMENTALS OF ACCOUNTING 2	2	AUT		2~4	Management

Registration CD	Course CD	Course title	Cr.	Semester offered	Instructor	Student Year	Course Offering Department
EMGS5050	468048	GLOBAL MARKETING 1	2	Not Offered		2~4	Management
EMGS5051	468049	GLOBAL MARKETING 2	2	1Q		2~4	Management
EMGS5054	468071	INNOVATION MANAGEMENT	2	Not Offered		2~4	Management
EMGS5039	468034	MANAGEMENT ACCOUNTING 1	2	Not Offered		2~4	Management
EMGS5040	468035	MANAGEMENT ACCOUNTING 2	2	Not Offered		2~4	Management
EMGS5048	468040	MARKETING STRATEGY 1	2	SPR		2~4	Management
EMGS5049	468041	MARKETING STRATEGY 2	2	AUT		2~4	Management
EMGS5036	468047	ORGANIZATIONAL THEORY AND ANALYSIS	2	AUT		2~4	Management
EMGS5043	408010	GLOBAL BRANDING	2	AUT		3~4	Management
EMGS5027	468062	INTERNATIONAL ACCOUNTING	2	SPR		3~4	Management
EMGS5033	468044	SPECIAL TOPICS IN MANAGEMENT 1	2	AUT		3~4	Management
EMGS5034	468045	SPECIAL TOPICS IN MANAGEMENT 2	2	SPR		3~4	Management
EMGS5046	468038	SPECIAL TOPICS IN MARKETING	2	2Q		2~4	Management
BGSS3003	BGS20000	BASICS OF INTERNATIONAL COOPERATION B	2	SPR		2~4	Global Studies
BGSS3000	BGS50201	GLOBALIZATION AND ECONOMICS 2	2	AUT		2~4	Global Studies
BGSS3001	BGS59700	INTERNATIONAL POLITICS: THEORY AND PRACTICE	2	AUT		2~4	Global Studies
BGSS3002	BGS59800	INTERNATIONAL ORGANIZATION: THEORY AND PRACTICE	2	SPR		2~4	Global Studies
BGSS3011	BGS20004	AFRICA'S DEVELOPMENT AID	2	AUT		2~4	Global Studies
BGSS3012	BGS20005	ANTHROPOLOGY OF SUFFERINGS AND HOPES IN AFRICA	2	AUT		2~4	Global Studies
BGSS3013	BGS20006	BASICS OF THEORIES OF CIVIL SOCIETY B	2	AUT		1~2	Global Studies
BGSS3016	BGS59500	ASIAN POLITICS	2	SPR		2~4	Global Studies
BGSS3014	BGS20007	CONFLICT RESOLUTION B	2	AUT		3~4	Global Studies
BGSS3008	BGS58300	CONTEMPORARY SOCIETIES OF THE MIDDLE EAST	2	AUT		2~4	Global Studies
BGSS3006	BGS20002	EDUCATION FOR MINORITIES IN JAPAN	2	AUT		2~4	Global Studies
BGSS3010	BGS58100	LIFE AND CULTURE IN AFRICA	2	AUT		2~4	Global Studies
BGSS3015	BGS59000	PEACE RESEARCH	2	SPR		3~4	Global Studies
BGSS3017	BGS20008	MODERN HISTORY OF THE MIDDLE EAST B	2	AUT		2~4	Global Studies
BGSS3007	BGS57900	SOCIETY AND POLITICS IN SOUTH ASIA	2	AUT		3~4	Global Studies
BGSS3005	BGS58500	THEORY OF INTERNATIONAL POLITICS	2	AUT		3~4	Global Studies
BGSS4005	BGS57507	ADVANCED STUDIES (CONTEMPORARY SOCIETIES OF ASIA)	2	SPR		3~4	Global Studies
BGSS4004	BGS57508	ADVANCED STUDIES (CULTURES AND SOCIETIES OF ASIA)	2	SPR		3~4	Global Studies
BGSS4002	BGS25000	ADVANCED STUDIES (DEMOCRACY AND CONFLICT)	2	SPR		2~4	Global Studies
BGSS4006	BGS57517	ADVANCED STUDIES (GLOBAL MIGRATION AND KOREANS IN JAPAN)	2	AUT		3~4	Global Studies
BGSS4001	BGS57516	ADVANCED STUDIES (INTERNATIONAL HUMAN RIGHTS)	2	SPR		3~4	Global Studies
BGSS4003	BGS57505	ADVANCED STUDIES (INTERNATIONAL ORGANIZATION B)	2	SPR		3~4	Global Studies

Instructor's name with * = adjunct instructor

Department of Economics SPSF Curriculum

Education and Research Objectives

To pursue in-depth study of fundamental Micro- and Macro-economic theory, through seminars, lectures and other types of small-class teaching, and to theoretically and empirically examine issues related to economics in contemporary society.

Human Resource Development Objectives

To produce graduates capable of applying economic concepts and tools to analyse contemporary social problems and phenomena; and of developing innovative ideas, utilising economic concepts, and analytical skills to critically examine global society.

Diploma Policy

The Department of Economics sets standards for the skills and knowledge that students are required to achieve prior to graduation. Those who fulfill the graduation requirements will be awarded a diploma, being deemed to have acquired the following:

1. In-depth understanding of the approaches and concepts used in Microeconomics and Macroeconomics, which constitute the core of economic theory; and the ability to explain the concepts in their own words.
2. The ability to develop models or conceptual frameworks based on knowledge of economics, in order to explain genuine issues in modern society and suggest viable approaches to solving the problems.
3. The ability to utilize economic knowledge and skills to perform statistical data analysis.
4. High-level communication and leadership skills that enable an appropriate contribution to be made to the global community.
5. High-level expertise that enable each student to become a leader in modern society in accordance with their own individual qualities and interests.

In addition to the above, the SPSF course sets the following abilities which students should acquire before graduation as common requirements across its six departments (Department of Journalism, Department of Education, Department of Sociology, Department of Economics, Department of Management, Department of Global Studies).

6. The ability to learn the basic knowledge on “Sustainable Futures,” to understand its importance, and to take action towards resolving challenges to the sustainable futures by drawing upon their academic discipline as well as from the other five disciplines in the SPSF course they learn.
7. The ability to understand and apply the interdisciplinary perspectives and methodologies, learned in their academic discipline and in the other five disciplines of the SPSF course, when addressing issues and presenting their ideas.

Curriculum Policy

For the purpose of achieving the requirements of the Diploma Policy, the Department of Economics has structured its curriculum as follows:

1. Students acquire fundamental knowledge of economic theory through Compulsory Courses (Introduction to Macroeconomics, Introduction to Microeconomics).
2. Students to gain logical thinking skills and develop models to describe and analyse socioeconomic phenomena through applied Microeconomics and/or Macroeconomics (which are Elective Compulsory Courses) .
3. Students acquire statistical analysis skills through data analysis courses (Introduction to Statistics, Introduction to Data Analysis)
4. Students are provided with the opportunity for group discussions and group learning through Active Learning Seminars and Seminars so that they acquire the communication skills necessary to enable problem solving in cooperation with others.
5. From a global perspective, a diverse range of Specialized Courses is offered (International Economics and Business, Environmental and Natural Resource Economics, Global Health Policies, Health Economics, International Finance, etc.) as Elective Compulsory Courses in order for students to deepen their understanding of applying economic theory to modern society.
6. Based on the fundamental knowledge required in the common goals described in the Diploma Policy and in

order to support students to acquire expertise while exploring their own individual qualities and interests, students are able to select various Specialized Courses, including courses offered by other departments and faculties, in addition to advanced economics courses.

In addition to the above, the SPSF course constructs its curriculum in the following manner, for the purpose of achieving the common diploma policy across the six departments:

7. To enable the students during the first year to acquire a basic knowledge on “Sustainable Futures” and the relating issues through the SPSF General Studies Courses, drawing on the perspectives of six disciplines. Based on the acquired knowledge, the students will be able to deepen their understanding in various challenges related to the sustainable futures through Elective Courses in the University-wide General Studies Courses, and they will be also able to learn about the approaches, contents, and methodologies of the different disciplines through Specialized Courses offered by each department.
8. To enable students to gradually gain knowledge of the different disciplines of each Department and also acquire a wide range of knowledge through the courses offered by other faculties and departments which have been designated to offer Elective Compulsory Courses or Elective Courses. Thus, the students will be able to acquire the various perspectives, contents, and methodologies, as well as comprehensive approaches from the courses.

1. Courses and Minimum Number of Credits Required for Graduation

【For students who entered from 2022】

General Studies (Zengaku Kyotsu Kamoku)

Compulsory: 8 credits (Studies in Christian Humanism: For Others, With Others, Liberal Arts of the Body: 1 Credit, Critical Thinking & Discussion, Overview of Data Science, Thinking about Issues, Perspectives and Positionality: 2 Credits)

Compulsory electives: 6 credits (Studies in Christian Humanism: 2 Credits, Advanced General Education Courses: 4 Credits (including SPSF Common Core: Theme Based "Third Year Seminar for Sustainable Futures" 2 credits)

Electives: 12 credits (including SPSF Common Core: Theme Based "First Year Lecture in/about Sustainable Futures" 4 credits)

Language

Compulsory: 4 credits (SPSF Common Core: Academic Skills “Academic Writing 1 & 2”)

Specialized Education (Gakka Kamoku)

Compulsory: 8 credits

Electives: 86 credits
(including SPSF Common Core: Academic Skills “Academic Presentations” 2 credits)

Total: 124 credits are required for graduation.

【For students who entered from 2020 to 2021】

General Studies (Zengaku Kyotsu Kamoku)

Compulsory: 2 credits (Health and Physical Education: 2 credits)

Compulsory electives: 4 credits (Studies in Christian Humanism)

Electives: 20 credits
(including SPSF Common Core: Theme Based “First Year Lecture in/about Sustainable Futures” and “Third Year Seminar for Sustainable Futures (Advanced General Education course)” 6 credits)

Language

Compulsory: 4 credits (SPSF Common Core: Academic Skills “Academic Writing 1 & 2”)

Specialized Education (Gakka Kamoku)

Compulsory: 8 credits

Electives: 86 credits (including SPSF Common Core: Academic Skills “Academic Presentations”, and “Critical Thinking & Discussion” 4 credits)

Total: 124 credits are required for graduation.

2. Distribution of Required Credits

Please see page 157.

3. Guidelines for Course Registration

Please read this Handbook carefully to find out about courses required for graduation and the minimum standards for the number of credits (Compulsory, Compulsory Electives, Electives), etc.

① Precautions regarding the number of credits required for Specialized Education (SE) courses

- (1) Students are advised to take as many Specialized Education (SE) courses specified in Major Core (Compulsory Electives) courses as possible.
- (2) When students have obtained the specified number of credits for graduation in Major Core (Compulsory Electives) courses, the excess amount will be regarded as SE Electives.
- (3) If students take the same course twice, they will only be able to count the credits they obtained for taking the course once toward graduation. The same course refers to; ① a course with the same title, and ② a course that is described in the Handbook as being considered to be the same course even if the title of the course is different.

② Precautions regarding the year of study

- (1) Students can register for any General Studies courses regardless of which year they are in except for Advanced General Education Courses.
- (2) Foreign Language courses and Language courses
Students are advised to take Language courses (SPSF Common Core (Academic Skills)) in the first year.
- (3) The year of study shown in the list of assigned courses and the numbering is the standard for the year of study for Specialized Education Compulsory Electives and Elective courses.
- (4) Seminars and Bachelor Thesis
 - SPSF students have the opportunity to take Japanese-style seminars and write a final Bachelor thesis.
 - Japanese-style seminars are small-size discussion classes taken during four consecutive semesters.
 - Two options for SPSF students:
 - “SPSF Seminars” series offered in English, SPSF Seminar: Microeconomics 1, 2, 3, and 4, and SPSF Seminar-Macroeconomics 1, 2, 3, and 4.
 - Japanese Track “Seminar (演習) 1,2, 3, 4”
- (5) Seminars require special registration at the beginning of the 2nd year.
- (6) Once the registration for seminars is completed, students cannot change their seminars.
- (7) Seminars, which can be either SPSF seminars or the Japanese Track seminars, are a precondition for writing a Bachelor thesis.
- (8) If students plan to take Seminars, it's necessary for students to get the approval of the professor in the Autumn semester of their second year.
- (9) If students plan to write Bachelor thesis under the supervision of professors in the Japanese Track seminar, they must receive explicit approval from them for thesis supervision at the time of registration.

③ Precautions regarding Specialized Education (SE) courses

- (1) Obtaining credits for courses other than courses described in the list of assigned courses:
 - a) When students have obtained credits for Compulsory Elective courses in the Economics Department Japanese Track course, a maximum of 8 credits can be counted as credits for SPSF Compulsory Elective courses.
 - b) If the number of credits for Compulsory Elective courses in the Economics Department Japanese Track course exceeds 8, up to 24 excess credits can be added to credits of SPSF Elective course.
 - c) Other Faculty/Department Courses, Courses for Teacher & Curator Certification with course numbers starting with 62, except “Teaching Practice 1, 2, 3 (教育演習 1,2,3)” and “Museum Curator Field Work 1, 2 (博物館実習 1,2)” and General Studies Course(s) – SAIMS Program course(s) are included as credits for SPSF Elective courses up to a maximum of 16 credits.
 - d) However, General Studies courses apart from the SAIMS Program cannot be included as credits for SPSF Elective courses.
- (2) Regarding prerequisite courses
 - a) Department of Economics students who take compulsory elective and specialized elective courses from the department should note that prior to enrollment it is highly recommended that they finish successfully

- complete “INTRODUCTION TO MICROECONOMICS”, “INTRODUCTION TO MACROECONOMICS”, and “INTRODUCTION TO STATISTICS”.
- b) Also, to enroll in Japanese Track courses shown in the table below, successful completion of 3 courses out of 4 following compulsory courses are required: “INTRODUCTION TO MICROECONOMICS”, “INTRODUCTION TO MACROECONOMICS”, “INTRODUCTION TO STATISTICS” and “INTRODUCTION TO DATE ANALYSIS”. These courses are called “prerequisite”
- c) Consultation with your academic advisor or the course instructor is advised.

Japanese Track Courses having Prerequisite Courses

選択必修科目 (B群)	計量経済学I 計量経済学II 国際貿易論I 国際貿易論II 金融論I 金融論II 財政学I 財政学II 経済発展論 公共経済学II 労働経済学I 労働経済学II 環境経済学	選択科目 (C-1群)	中級ミクロ経済学 中級マクロ経済学 公共政策I 公共政策II
----------------	--	----------------	---

- (3) Precautions related to Category A, B and C: Course Categories (Compulsory, Compulsory Electives, Electives) need to follow Handbook of the year in which the credits were obtained.

④ Handling Standards relating to Credit Recognition for Department of Economics courses taken by Students who changed Faculty/Department

A maximum of 20 credits are allocated for credit recognition for Department of Economics courses obtained by students before they changed Faculty/Department

⑤ Course Numbering

Numbering shown in the list of assigned courses refer to the following. For information about numbering, refer to p.24 in the Handbook.

Field (alphabets)	Field (English)	Field (Japanese)
ECN	Economics	経済学
MAN	Management	経営学
LAW	Law in general	法律一般
TCP	Teacher-training Course Program	教職科目

4. Early graduation

① Department of Economics Early Graduation System

Early graduation refers to an enrollment period of at least 3 years (excluding periods of absence), and graduating at the end of the 3rd year or at the end of the Autumn Semester in the 4th year, upon completion of prescribed procedures (hereinafter referred to as “graduation in September of the 3rd year” or “graduation in March of the 4th year”, respectively).

② In order to graduate early, all of the following requirements must be fulfilled.

- (1) The student must wish to graduate early.
- (2) At the time of early graduation, the student must have obtained all the credits for prescribed courses necessary for graduation.
- (3) The Grade Point Average (hereafter referred to as “the GPA”) for the total number of credits obtained must be 3.5 or more at the time of early graduation. GPA is calculated based on Sophia University Article 55.

- ③ When requesting early graduation, it is necessary to apply for early graduation registration.
- (1) In order to apply for early graduation registration, it is necessary to satisfy the following requirements:
 - a) Upon completion of the 2nd year, students are required to obtain at least 62 credits from Sophia University that count toward graduation.
 - b) The GPA for the abovementioned number of credits obtained is 3.0 or above.
 - (2) The procedures for registering a request for early graduation are as follows:
 - a) Students are required to receive an Application for Early Graduation Registration in the predetermined format at the Department of Economics Office.
 - b) After receiving an approval seal/signature from your seminar supervisor (hereinafter referred to as the “supervisor”. If you are not taking a seminar, receive a stamp from the Chairperson), submit the form to the Chairperson by the submission deadline.
 - (3) After registering a request for early graduation, it is necessary to receive course guidance from your supervisor, report your academic progress to the supervisor regularly and receive appropriate guidance.
- ④ Changes to the graduation period and withdrawal of early graduation registration will be carried out as follows:
- (1) To alter the period of a request for early graduation, it is necessary to receive an approval seal/signature from your supervisor on the prescribed Notice of Changes to Period of Request for Early Graduation, and submit it to the Chairperson by the submission deadline.
 - (2) To withdraw early graduation registration, it is necessary to receive an approval seal/signature from your supervisor on the prescribed Notice of Withdrawal of Registration of Request for Early Graduation, and submit it to the Chairperson by the deadline.
- ⑤ If a student wishing to graduate in September of the 3rd year as prescribed subsequently withdraws early graduation registration, he or she may register for early graduation in March of the 4th year in September of the 4th year provided that the Chairperson considers that special circumstances exist. If a student wishes to reregister, it is necessary to receive authorization from the Chairperson in advance and submit a re-application for Early Graduation Registration to the Chairperson.

For details, inquire at the Department of Economics Office (Room 2-1115a, 11th Floor, Building No. 2)

Documents to be Submitted	Submission Period	
Application for Early Graduation Registration	September of the 3 rd year	
Re-Application for Early Graduation Registration	March of the 4 th year	
Notice of Changes to Period of Request for Early Graduation	By the last day of the course registration period in the Autumn Semester of the 3 rd year	
Notice of Withdrawal of Registration of Request for Early Graduation	In the case of cancellation of graduation in March of the 3 rd year	Suspension period of 4 th quarter courses in the Autumn Semester of the 3 rd year
	In the case of cancellation of graduation in September of the 4 th year	Suspension period of 2 nd quarter courses in the Spring Semester of the 4 th year

5. Distribution of Required Credits

[For students who entered from 2022] Department of Economics

O General Studies: University-Wide General Studies (26 credits)

	1st Year		2nd Year		3rd Year		4th Year	
	Autumn Semester course title	Spring Semester course title	Autumn Semester course title	Spring Semester course title	Autumn Semester course title	Spring Semester course title	Autumn Semester course title	Spring Semester course title
Compulsory	8 cr	2						
	Studies in Christian Humanism: For Others, With Others Liberal Arts of the Body Thinking about Issues, Perspectives and Positionality	Critical Thinking & Discussion Overview of Data Science						
Compulsory Electives	6 cr		2					
	Studies in Christian Humanism Advanced General Education Courses SPSF Common Core(Theme Based)		Studies in Christian Humanism				Advanced General Education Courses	
Electives	12cr				2			
	First Year Lecture in/about Sustainable Futures General Studies Elective Courses taught in English First-year students may take General Studies Elective Courses up to 4 credits each semester Language(s): up to 8 cr ※1,3 Credits earned in excess of 6 credits in Compulsory Electives will be counted into Electives.				Third Year Seminar for Sustainable Futures			

O Language (4 credits)

	1st Year		2nd Year		3rd Year		4th Year	
	Autumn Semester course title	Spring Semester course title	Autumn Semester course title	Spring Semester course title	Autumn Semester course title	Spring Semester course title	Autumn Semester course title	Spring Semester course title
Compulsory	4 cr	2						
	SPSF Common Core (Academic Skills)	Academic Writing 1		Academic Writing 2				

O Specialized Education (94 cr)

	1st Year		2nd Year		3rd Year		4th Year	
	Autumn Semester course title	Spring Semester course title	Autumn Semester course title	Spring Semester course title	Autumn Semester course title	Spring Semester course title	Autumn Semester course title	Spring Semester course title
Compulsory	8 cr	2		2				
	Major Core (Compulsory)	Introduction to Microeconomics		Introduction to Data Analysis				
Compulsory Electives	2 cr	2						
	SPSF Common Core (Academic Skills)	Academic Presentations						
Electives	50 cr							
	Major Core (Compulsory Electives)	34 cr						
	SE Electives, Category C: up to 50 cr							
	The excess credits of Major Core (Compulsory Electives), Category B: up to 50 cr							
	Economics Department Japanese Track the excess credits of Compulsory Electives (選択必修) Course(s): up to 24 cr ※1,2,3,4							
	FLA course(s) with course numbers starting with "IBE": up to 50 cr							
	Language(s): up to 4 cr ※1,5							
	Up to 16 credits in total:							
	Other Faculty/Department Course(s) ※1							
	Course(s) for Teacher & Curator Certification with course numbers starting with 62, except "Teaching Practice 1, 2, 3 (教育実習1, 2, 3)" and "Museum Curator Field Work 1, 2 (博物館実習1, 2)" ※2							
	SAIMS Program course(s)							

※1 No more than 24 credits of courses taught in Japanese in total.

※2 ENGLISH FOR ECONOMICS 1 (BASIC)(経済英語 I (BASIC)), "ENGLISH FOR ECONOMICS 2 (BASIC)(経済英語 II (BASIC))", "ENGLISH FOR ECONOMICS 1 (INTERMEDIATE)(経済英語 I (INTERMEDIATE))", "ENGLISH FOR ECONOMICS 2 (INTERMEDIATE)(経済英語 II (INTERMEDIATE))", "ENGLISH FOR ECONOMICS 1 (SPECIALIZED)(経済英語 I (SPECIALIZED))", "ENGLISH FOR ECONOMICS 2 (SPECIALIZED)(経済英語 II (SPECIALIZED))" offered in own department's Japanese Track are not included in graduation requirements.

※3 Language Courses offered by OLER in own Department's Japanese Track are not included in graduation requirements.

※4 If students expect to take Japanese Track "Seminar 1, 2, 3, 4(演習1,2,3,4)", it's necessary for students to pass their advisor's examinations in the Autumn semester of their second year.

※5 For details regarding Language courses, see p.117, "LANGUAGES (OTHER THAN ENGLISH)" and SPSF Language Courses chart

【For students who entered from 2020 to 2021】Department of Economics

O General Studies: University-Wide General Studies (26 credits)

	1st Year		2nd Year		3rd Year		4th Year	
	Autumn Semester course title	Spring Semester course title	Autumn Semester course title	Spring Semester course title	Autumn Semester course title	Spring Semester course title	Autumn Semester course title	Spring Semester course title
Compulsory Electives	2 cr		2					
Compulsory Electives	4 cr		4					
Electives	First Year Lecture in/about Sustainable Futures		Third Year Seminar for Sustainable Futures (Advanced General Education course)		2			
	6 cr							
Electives	- General Studies Elective Courses taught in English							
	14 cr		- Japanese or any other Language(s): up to 8 cr ※1,5					

O Language (4 credits)

	1st Year		2nd Year		3rd Year		4th Year	
	Autumn Semester course title	Spring Semester course title	Autumn Semester course title	Spring Semester course title	Autumn Semester course title	Spring Semester course title	Autumn Semester course title	Spring Semester course title
Compulsory	4 cr		2					
Compulsory (Academic Skills)	4 cr		2					

O Specialized Education (94 cr)

	1st Year		2nd Year		3rd Year		4th Year	
	Autumn Semester course title	Spring Semester course title	Autumn Semester course title	Spring Semester course title	Autumn Semester course title	Spring Semester course title	Autumn Semester course title	Spring Semester course title
Compulsory	8 cr		2					
Compulsory Electives	4 cr		2					
Major Core (Compulsory)	Introduction to Microeconomics		Introduction to Statistics		Introduction to Data Analysis			
	34 cr							
Major Core (Compulsory Electives)	Academic Presentations		Critical Thinking & Discussion					
	4 cr							
SE Electives	- Major Core (Compulsory Electives) Discipline/Research, Category B: Minimum requirement credits is 4 cr, up to 30 cr							
	34 cr		- Major Core (Compulsory Electives), Category B: up to 30 cr					
SE Electives	- Economics Department Japanese Track's Compulsory Electives (選択必修) Course(s) only, up to 8 cr ※1,2,3,4							
	48 cr		- SE Electives, Category C: up to 48 cr					
SE Electives	- The excess credits of Major Core (Compulsory Electives), Category B: up to 48 cr							
	48 cr		- Economics Department Japanese Track the excess credits of Compulsory Electives (選択必修) and Electives (選択) Course(s): up to 24 cr ※1,2,3,4					
SE Electives	- FLA course(s) with course numbers starting with "IBE": up to 48 cr							
	48 cr		- Language(s): up to 4 cr ※1,5					
SE Electives	Up to 16 credits in total:							
	- Other Faculty/Department Course(s) ※1							
SE Electives	- Course(s) for Teacher & Curator Certification with course numbers starting with 62, except "Teaching Practice 1, 2, 3 (教育実習1, 2, 3)" and "Museum Curator Field Work 1, 2 (博物館実習1, 2)" ※1							
	48 cr		- SAIMS Program course(s)					

※1 No more than 24 credits of courses taught in Japanese in total.

※2 "ENGLISH FOR ECONOMICS 1 (BASIC)(経済英語 I (BASIC))", "ENGLISH FOR ECONOMICS 2 (BASIC)(経済英語 II (BASIC))", "ENGLISH FOR ECONOMICS 1 (INTERMEDIATE)(経済英語 I (INTERMEDIATE))", "ENGLISH FOR ECONOMICS 2 (INTERMEDIATE)(経済英語 II (INTERMEDIATE))", "ENGLISH FOR ECONOMICS 1 (SPECIALIZED)", "ENGLISH FOR ECONOMICS 2 (SPECIALIZED)", "ENGLISH FOR ECONOMICS 1 (SPECIALIZED)", "ENGLISH FOR ECONOMICS 2 (SPECIALIZED)" offered in own department's Japanese Track are not included in graduation requirements.

※3 Language Courses offered by CLER in own Department's Japanese Track are not included in graduation requirements.

※4 If students expect to take Japanese Track "Seminar 1, 2, 3, 4(演習1,2,3,4)", it's necessary for students to pass their advisor's examinations in the Autumn semester of their second year.

※5 For details regarding Language courses, see p.117, "LANGUAGES (OTHER THAN ENGLISH)", and SPSF Language Courses chart

6. Specialized Education Courses

Please refer to All SPSF Course List (p.184~p.190) of the departments which offer the courses for detailed information.

Journalism: p.184 Education: p.185 Sociology: p.186 Economics: p.187 Management:p.188 Global Studies:p.189 Other departments:p.190

Category A : Major Core (Compulsory)

Registration CD	Course CD	Course title	Cr.	Semester offered	Instructor	Student Year	Course Offering Department
EECS1002	498008	INTRODUCTION TO MACROECONOMICS	2	Not Offered	SCHLEGL, Matthias	1	Economics
EECS1001	498007	INTRODUCTION TO MICROECONOMICS	2	AUT	NAKAMURA, Sayaka	1	Economics
EECS1003	498017	INTRODUCTION TO STATISTICS	2	SPR	NAKAMURA, Sayaka	1	Economics
EECS1004	498009	INTRODUCTION TO DATA ANALYSIS	2	AUT	SCHLEGL, Matthias	1	Economics

Category B : Major Core (Compulsory Electives)

【Research】

Registration CD	Course CD	Course title	Cr.	Semester offered	Instructor	Student Year	Course Offering Department
HSCS1030	289202	QUANTITATIVE METHODS IN SOCIOLOGY	2	SPR		1	Sociology
HSCS2030	289203	QUALITATIVE METHODS IN SOCIOLOGY	2	AUT		2	Sociology
EMG60911	468068	CHALLENGING FRONTLINE ISSUES IN GLOBAL BUSINESS	4	SPR		3~4	Management

【Discipline】

Registration CD	Course CD	Course title	Cr.	Semester offered	Instructor	Student Year	Course Offering Department
HJNS1010	268801	COMMUNICATION 1	2	AUT		1~4	Journalism
HEDS1030	147003	EDUCATION AND INTERNATIONAL DEVELOPMENT	2	SPR		2~4	Education
HEDS1010	147000	INTRODUCTION TO COMPARATIVE EDUCATION	2	AUT		2~4	Education
HSCS1010	289200	PRINCIPLES OF SOCIOLOGY	2	AUT		1	Sociology
EMGS5001	468058	PRINCIPLES OF ACCOUNTING	2	AUT		1~4	Management
EMGS5032	468033	PRINCIPLES OF MANAGEMENT	2	AUT		1~4	Management
EMGS5047	468039	PRINCIPLES OF MARKETING	2	AUT		1~4	Management
EMGS5048	468040	MARKETING STRATEGY 1	2	SPR		2~4	Management
EMGS5037	468052	STRATEGIC MANAGEMENT	2	SPR		2~4	Management
BGSS1030	BGSS1030	INTRODUCTION TO AREA STUDIES	2	AUT		1	Global Studies
BGSS1010	BGSS1010	INTRODUCTION TO GLOBAL STUDIES	2	AUT		1	Global Studies
BGSS1020	BGSS1020	INTRODUCTION TO INTERNATIONAL RELATIONS	2	AUT		1	Global Studies

【Major Core (Compulsory Electives)】

Registration CD	Course CD	Course title	Cr.	Semester offered	Instructor	Student Year	Course Offering Department
EECS5018	498021	MATHEMATICS FOR ECONOMICS	2	AUT	KAWANISHI, Satoshi	1~4	Economics
EECS5019	498016	AFRICAN ECONOMY	2	Not Offered	Staff	2~4	Economics
EECS5020	498015	ASIAN ECONOMY	2	AUT	KEOLA, Souknilanh	2~4	Economics
EECS5008	402110	CONTEMPORARY ISSUES IN INTERNATIONAL DEVELOPMENT	2	SPR	OGURA, Tatsuya	2~4	Economics
EECS5025	402080	ENVIRONMENTAL AND NATURAL RESOURCE ECONOMICS	2	SPR	HORIE, Tetsuya	2~4	Economics
EECS5026	402100	GAME THEORY	2	AUT	KAMAGA, Kohei	2~4	Economics

Registration CD	Course CD	Course title	Cr.	Semester offered	Instructor	Student Year	Course Offering Department
EECS5007	467969	GLOBAL DEVELOPMENT GOALS	2	AUT	PUTHENKALAM, John Joseph	2~4	Economics
EECS5005	402090	GLOBAL ECONOMIC HISTORY	2	Not Offered	Staff	2~4	Economics
EECS5030	498028	QUANTITATIVE ANALYSIS OF SOCIAL ISSUES	2	SPR	NAKAMURA, Sayaka	2~4	Economics
EECS5031	498029	ECONOMICS OF SOCIAL POLICY	2	AUT	NAKAMURA, Sayaka	2~4	Economics
EECS5001	402060	INTERNATIONAL ECONOMICS AND BUSINESS	2	AUT	YOMOGIDA, Morihiro	2~4	Economics
EECS5024	498010	INTERNATIONAL FINANCE	2	SPR	SCHLEGL, Matthias	2~4	Economics
EECS5004	402120	JAPANESE ECONOMY 1	2	AUT	MINAMIHASHI, Naoaki	2~4	Economics
EECS5012	498022	SEMINER-ECONOMICS AND GLOBAL HEALTH 1	2	Not Offered	Staff	2~4	Economics
EECS5028	498026	ACTIVE LEARNING SEMINAR1	2	SPR	NAKAMURA, Sayaka	2~4	Economics
EECS5011	498014	POVERTY IN THE GLOBAL ECONOMY	2	2Q	TAKAMATSU, Shinya*	2~4	Economics
EECS5002	498024	PUBLIC ECONOMICS 1	2	SPR	KONDO, Hiroki	2~4	Economics
EECS5027	498025	INTERMEDIATE MACROECONOMICS	2	AUT	SCHLEGL, Matthias	2~4	Economics
EECS5022	498023	SEMINER-ECONOMICS AND GLOBAL HEALTH 2	2	Not Offered	Staff	2~4	Economics
EECS5029	498027	ACTIVE LEARNING SEMINAR2	2	AUT	NAKAMURA, Sayaka	3~4	Economics
EECS5801	498030	SPSF SEMINAR: MICROECONOMICS 1	2	Not Offered	NAKAMURA, Sayaka	3	Economics
EECS5802	498031	SPSF SEMINAR: MICROECONOMICS 2	2	Not Offered	NAKAMURA, Sayaka	3	Economics
EECS5803	498032	SPSF SEMINAR: MICROECONOMICS 3	2	Not Offered	NAKAMURA, Sayaka	4	Economics
EECS5804	498033	SPSF SEMINAR: MICROECONOMICS 4	2	Not Offered	NAKAMURA, Sayaka	4	Economics
EECS5805	498034	SPSF SEMINAR: MACROECONOMICS 1	2	SPR	SCHLEGL, Matthias	3	Economics
EECS5806	498035	SPSF SEMINAR: MACROECONOMICS 2	2	AUT	SCHLEGL, Matthias	3	Economics
EECS5807	498036	SPSF SEMINAR: MACROECONOMICS 3	2	SPR	SCHLEGL, Matthias	4	Economics
EECS5808	498037	SPSF SEMINAR: MACROECONOMICS 4	2	AUT	SCHLEGL, Matthias	4	Economics
EECS5900	499000	BACHELOR'S THESIS	4	Not Offered	Staff	4	Economics

Category C : SE Electives

Registration CD	Course CD	Course title	Cr.	Semester offered	Instructor	Student Year	Course Offering Department
HJNS5010	268811	INTERNATIONAL COMMUNICATION 1	2	Not Offered		2~4	Journalism
HJNS5020	268812	INTERNATIONAL COMMUNICATION 2	2	Not Offered		2~4	Journalism
HJNS5030	268813	MASS MEDIA 1	2	Not Offered		3~4	Journalism
HJNS5040	268814	MASS MEDIA 2	2	Not Offered		3~4	Journalism
HEDS1050	147001	COMPARATIVE EDUCATION IN ASIA	2	SPR		2~4	Education
HEDS1040	147004	CURRICULUM AND INSTRUCTION	2	SPR		2~4	Education
HEDS1020	147002	INTERNATIONAL EDUCATION	2	AUT		2~4	Education
HEDS5010	147021	SPECIAL TOPICS IN EDUCATION 1: PHILOSOPHY OF EDUCATION	2	Not Offered		2~4	Education
HEDS5020	147022	SPECIAL TOPICS IN EDUCATION 2: SOCIOLOGY OF EDUCATION	2	SPR		2~4	Education
HEDS5030	147023	SPECIAL TOPICS IN EDUCATION 3: CURRENT ISSUES IN EDUCATION IN ASIA	2	AUT		2~4	Education
HEDS5040	147024	SPECIAL TOPICS IN EDUCATION 4: EDUCATION FOR CRITICAL ACTION IN THE ANTHROPOCENE	2	AUT		2~4	Education

Registration CD	Course CD	Course title	Cr.	Semester offered	Instructor	Student Year	Course Offering Department
HEDS5050	147025	SPECIAL TOPICS IN EDUCATION 5: TBA	2	Not Offered		2~4	Education
HSCS5030	289221	CONTEMPORARY SOCIAL PROBLEMS	2	SPR		2~4	Sociology
HSCS5040	288807	SOCIAL CHANGE IN POSTWAR JAPAN	2	SPR		2~4	Sociology
HSCS2010	289204	SOCIOLOGICAL THEORY 1	2	AUT		2	Sociology
HSCS2020	289205	SOCIOLOGICAL THEORY 2	2	Not Offered		2	Sociology
HSCS5060	289222	SOCIOLOGY OF FAMILIES	2	Not Offered		2~4	Sociology
HSCS5050	284930	SOCIOLOGY OF GLOBALIZATION	2	SPR		2~4	Sociology
HSCS5010	289220	SOCIOLOGY OF HAPPINESS	2	AUT		2~4	Sociology
HSCS5020	288893	WORK AND EMPLOYMENT IN JAPAN	2	AUT		2~4	Sociology
HSCS5110	289224	SPECIAL TOPICS IN SOCIOLOGY 1	2	SPR		3~4	Sociology
HSCS5120	289225	SPECIAL TOPICS IN SOCIOLOGY 2	2	AUT		3~4	Sociology
HSCS5130	289226	ENVIRONMENTAL SOCIOLOGY	2	Not Offered		2~4	Sociology
EMGS5044	468036	CONSUMER BEHAVIOR 1	2	SPR		2~4	Management
EMGS5045	468037	CONSUMER BEHAVIOR 2	2	AUT		2~4	Management
EMGS5004	468059	FINANCIAL ACCOUNTING 1	2	SPR		2~4	Management
EMGS5005	468060	FINANCIAL ACCOUNTING 2	2	AUT		2~4	Management
EMGS5041	468050	FUNDAMENTALS OF ACCOUNTING 1	2	Not Offered		2~4	Management
EMGS5042	468051	FUNDAMENTALS OF ACCOUNTING 2	2	Not Offered		2~4	Management
EMGS5050	468048	GLOBAL MARKETING 1	2	1Q		2~4	Management
EMGS5051	468049	GLOBAL MARKETING 2	2	Not Offered		2~4	Management
EMGS5039	468034	MANAGEMENT ACCOUNTING 1	2	AUT		2~4	Management
EMGS5040	468035	MANAGEMENT ACCOUNTING 2	2	SPR		2~4	Management
EMGS5049	468041	MARKETING STRATEGY 2	2	AUT		2~4	Management
EMGS5035	468046	ORGANIZATIONAL BEHAVIOR	2	Not Offered		2~4	Management
EMGS5036	468047	ORGANIZATIONAL THEORY AND ANALYSIS	2	AUT		2~4	Management
EMGS5043	468010	GLOBAL BRANDING	2	AUT		2~4	Management
EMGS5027	468062	INTERNATIONAL ACCOUNTING	2	SPR		3~4	Management
EMGS5033	468044	SPECIAL TOPICS IN MANAGEMENT 1	2	SPR		3~4	Management
EMGS5034	468045	SPECIAL TOPICS IN MANAGEMENT 2	2	AUT		3~4	Management
EMGS5046	468038	SPECIAL TOPICS IN MARKETING	2	2Q		2~4	Management
EMGS5052	468069	ENTREPRENEURSHIP 1	2	SPR		2~4	Management
EMGS5053	468070	ENTREPRENEURSHIP 2	2	AUT		2~4	Management
EMGS5054	468071	INNOVATION MANAGEMENT	2	Not Offered		2~4	Management
BGSS3003	BGS20000	BASICS OF INTERNATIONAL COOPERATION B	2	SPR		2~4	Global Studies
BGSS3004	BGS20001	BASICS OF SOUTHEAST ASIAN STUDIES B	2	SPR		2~4	Global Studies
BGSS3011	BGS20004	AFRICA'S DEVELOPMENT AID	2	AUT		3~4	Global Studies
BGSS3012	BGS20005	ANTHROPOLOGY OF SUFFERINGS AND HOPES IN AFRICA	2	AUT		3~4	Global Studies
BGSS3016	BGS59500	ASIAN POLITICS	2	SPR		3~4	Global Studies

Registration CD	Course CD	Course title	Cr.	Semester offered	Instructor	Student Year	Course Offering Department
BGSS3014	BGS20007	CONFLICT RESOLUTION B	2	AUT		3~4	Global Studies
BGSS3008	BGS58300	CONTEMPORARY SOCIETIES OF THE MIDDLE EAST	2	Not Offered		3~4	Global Studies
BGSS3006	BGS20002	EDUCATION FOR MINORITIES IN JAPAN	2	1Q		3~4	Global Studies
BGSS3010	BGS58100	LIFE AND CULTURE IN AFRICA	2	AUT		3~4	Global Studies
BGSS3015	BGS59000	PEACE RESEARCH	2	SPR		3~4	Global Studies
BGSS3007	BGS57900	SOCIETY AND POLITICS IN SOUTH ASIA	2	AUT		3~4	Global Studies
BGSS3005	BGS58500	THEORY OF INTERNATIONAL POLITICS	2	AUT		3~4	Global Studies
BGSS3013	BGS20006	BASICS OF THEORIES OF CIVIL SOCIETY B	2	AUT		3~4	Global Studies
BGSS4005	BGS57507	ADVANCED STUDIES (CONTEMPORARY SOCIETIES OF ASIA)	2	Not Offered		3~4	Global Studies
BGSS4004	BGS57508	ADVANCED STUDIES (CULTURES AND SOCIETIES OF ASIA)	2	AUT		3~4	Global Studies
BGSS4002	BGS25000	ADVANCED STUDIES (DEMOCRACY AND CONFLICT)	2	Not Offered		3~4	Global Studies
BGSS4006	BGS57517	ADVANCED STUDIES (GLOBAL MIGRATION AND KOREANS IN JAPAN)	2	AUT		3~4	Global Studies
BGSS4001	BGS57516	ADVANCED STUDIES (INTERNATIONAL HUMAN RIGHTS)	2	AUT		3~4	Global Studies
BGSS4003	BGS57505	ADVANCED STUDIES (INTERNATIONAL ORGANIZATION B)	2	Not Offered		3~4	Global Studies
BGSS3017	BGS20008	MODERN HISTORY OF THE MIDDLE EAST B	2	AUT		3~4	Global Studies
LAW69000	333306	COMPARATIVE POLITICS	2	AUT		3~4	Law
LAW68000	390400	HUMAN SECURITY AND DEVELOPMENT	2	AUT		3~4	Law
LAW69300	333307	INTERNATIONAL INSTITUTIONS AND WORLD ORDER	2	AUT		3~4	Law
LAW68200	338010	INTERNATIONAL POLITICAL ECONOMY	2	SPR		3~4	Law
LAW52301	337503	JAPANESE POLITICS IN GLOBAL PERSPECTIVES	2	AUT		3~4	Law
AIBE3400	IBE340	ECONOMIC STATISTICS	4	Not Offered		3~4	FLA
AIBE3200	IBE320	HUMAN RESOURCE MANAGEMENT	4	AUT		3~4	FLA
AIBE3110	IBE311	INTERMEDIATE MICROECONOMICS	4	AUT		3~4	FLA
AIBE3030	IBE303	MANAGEMENT INFORMATION SYSTEMS	4	AUT		3~4	FLA
AIBE3260	IBE326	MONEY AND BANKING	4	SPR		3~4	FLA
AIBE3320	IBE332	WOMEN AND MEN IN THE LABOR MARKET	4	AUT		3~4	FLA

Instructor's name with * = adjunct instructor

Department of Management SPSF Curriculum

Education and Research Objectives

To impart high-level expertise and broad general knowledge and cultivate a capacity to understand and practice management using a diversity of approaches in actual social engagement.

Human Resource Development Objectives

To produce individuals who understand management in its local and global social contexts, and who can contribute not only to corporate management but also to the local and international communities through rational decision-making grounded in specialist knowledge.

Diploma Policy

The Department of Management sets standards for the skills and knowledge students should acquire before graduation as follows. Those who fulfill the graduation requirements shall be deemed to have acquired these qualities and will be awarded a diploma.

1. The knowledge and skills required to appropriately analyze management environments that are undergoing globalization and increasing complexity.
2. The ability to understand and explain the approaches and concepts of Management Studies as well as specialized knowledge.
3. The ability to efficiently collect and process complex and diverse information and take the lead in solving issues challenging society.
4. The ability to respect differences and diversity, engage in open and fair discussion and communicate information, in order to make appropriate decisions under strict constraints
5. The ability to acquire high-level communication skills and contribute to problem-solving by taking the initiative in international forums.

In addition to the above, the SPSF course sets the following abilities which students should acquire before graduation as common requirements across its six departments (Department of Journalism, Department of Education, Department of Sociology, Department of Economics, Department of Management, Department of Global Studies).

6. The ability to learn the basic knowledge on “Sustainable Futures,” to understand its importance, and to take action towards resolving challenges to the sustainable futures by drawing upon their academic discipline as well as from the other five disciplines in the SPSF course they learn.
7. The ability to understand and apply the interdisciplinary perspectives and methodologies, learned in their 73 academic discipline and in the other five disciplines of the SPSF course, when addressing issues and presenting their ideas.

Curriculum Policy

With an aim to achieve the Diploma Policy, the Department of Management constitutes its curriculum as follows:

1. Have freshmen acquire the learning skills, fundamental understanding of specialized knowledge, communication skills, logical thinking, and social ethics required in promoting specialized learning in the Main Core Courses, “Introduction to Management 1” and “Introduction to Management 2.”
2. Have students deepen their expertise in Specialized Courses and Seminars, and have them acquire the ability to solve the issues challenging society today.
3. Aim to foster a self-motivated attitude towards learning and improve communication skills through small-group courses offered throughout the four years of enrollment.
4. Offer courses taught by experienced business managers and practitioners that foster a realistic and practical sense of management and/or teach business in practice.
5. To have students intensively improve their proficiency in English, the language commonly spoken internationally, through English Courses, and at the same time offer Foreign Language Courses in order to have them acquire other foreign language skills.

In addition to the above, the SPSF course constructs its curriculum in the following manner, for the purpose of achieving the common diploma policy across the six departments:

6. To enable the students during the first year to acquire a basic knowledge on “Sustainable Futures” and the

relating issues through the SPSF General Studies Courses, drawing on the perspectives of six disciplines. Based on the acquired knowledge, the students will be able to deepen their understanding in various challenges related to the sustainable futures through Elective Courses in the University-wide General Studies Courses, and they will be also able to learn about the approaches, contents, and methodologies of the different disciplines through Specialized Courses offered by each department.

7. To enable students to gradually gain knowledge of the different disciplines of each Department and also acquire a wide range of knowledge through the courses offered by other faculties and departments which have been designated to offer Elective Compulsory Courses or Elective Courses. Thus, the students will be able to acquire the various perspectives, contents, and methodologies, as well as comprehensive approaches from the courses.

1. Courses and Minimum Number of Credits Required for Graduation

【For students who entered from 2022】

General Studies (Zengaku Kyotsu Kamoku)

Compulsory: 8 credits (Studies in Christian Humanism: For Others, With Others, Liberal Arts of the Body: 1 Credit, Critical Thinking & Discussion, Overview of Data Science, Thinking about Issues, Perspectives and Positionality: 2 Credits)

Compulsory electives: 6 credits (Studies in Christian Humanism: 2 Credits, Advanced General Education Courses: 4 Credits (including SPSF Common Core: Theme Based "Third Year Seminar for Sustainable Futures" 2 credits)

Electives: 12 credits (including SPSF Common Core: Theme Based "First Year Lecture in/about Sustainable Futures" 4 credits)

Language

Compulsory: 4 credits (SPSF Common Core: Academic Skills "Academic Writing 1 & 2")

Specialized Education (Gakka Kamoku)

Compulsory: 4 credits

Electives: 90 credits (including SPSF Common Core: Academic Skills "Academic Presentations", 2 credits)

Total: 124 credits are required for graduation.

2. Distribution of Required Credits

Please see page 167.

3. Guidelines for Course Registration

Please read this Handbook carefully to find out about courses required for graduation and the minimum standards for the number of credits (Compulsory, Compulsory Electives, Electives), etc.

① Precautions regarding the number of credits required for Specialized Education (SE) courses

- (1) Students are advised to take as many Specialized Education (SE) courses specified in Major Core (Compulsory Electives) courses as possible.
- (2) When students have obtained the specified number of credits for graduation in Major Core (Compulsory Electives) courses, the excess amount will be regarded as SE Electives.
- (3) If students take the same course twice, they will only be able to count the credits they obtained for taking the course once toward graduation. The same course refers to; ① a course with the same title, and ② a course that is described in the Handbook as being considered to be the same course even if the title of the course is different.

② Precautions regarding the year of study

- (1) Students can register for any General Studies courses regardless of which year they are in except for Advanced General Education Courses.
- (2) Foreign Language courses and Language courses
Students are advised to take Language courses (SPSF Common Core (Academic Skills)) in the first year.
- (3) The year of study shown in the list of assigned courses and the numbering is the standard for the year of

study for Specialized Education Compulsory Electives and Elective courses.

- (4) Students who wish to take Japanese Track "Seminar 1, 2, 3, 4(演習 1,2,3,4)" are required to first apply through the Faculty of Economics office and to pass their advisor's examinations in the Autumn semester of their second year. Students should follow relevant guidance from the Faculty of Economics.

③Precautions regarding Specialized Education (SE) courses

- (1) Obtaining credits for courses other than courses described in the list of assigned courses:

- a) When students have obtained credits for Compulsory Elective courses in the Department of Management Japanese Track course, a maximum of 8 credits can be counted as credits for SPSF Compulsory Elective courses.
- b) If the number of credits for Compulsory Elective courses in the Department of Management Japanese Track course exceeds 8, up to 24 excess credits can be added to SPSF Elective course credits for graduation.
- c) Other Faculty/Department Courses, Courses for Teacher & Curator Certification with course numbers starting with 62, except "Teaching Practice 1,2,3 (教育実習 1,2,3) and "Museum Curator Field Work 1,2 (博物館実習 1,2) and General Studies Course(s) - SAIMS Program course(s) and データサイエンスプログラム基礎科目 (←2022 基盤の科目、名称及び科目詳細について検討中のため、決定後に英語名称を記載する) are included as credits for SPSF Elective courses up to a maximum of 12 credits.
- d) However, General Studies courses apart from the SAIMS Program cannot be included as credits for SPSF Elective courses.

- (2) Regarding prerequisite courses:

- a) Department of Management students who take compulsory elective and specialized elective courses from the Department of Economics should note that prior to enrolment it is highly recommended that they first successfully complete Economics compulsory courses "INTRODUCTION TO MICROECONOMICS" and "INTRODUCTION TO MACROECONOMICS". In addition, successful completion of course "INTRODUCTION TO STATISTICS" is also recommended.
- b) Likewise, for Japanese Track compulsory electives offered by the Department of Economics, completion of the above SPSF English language courses OR the Japanese Track courses 経済学総論I and 経済学総論II, which are available to Department of Management students, is highly recommended.
- c) Consultation with your academic advisor or the course instructor is advised.

- (3) Precautions related to Category A, B and C: Course Categories (Compulsory, Compulsory Electives, Electives) need to follow Handbook of the year in which the credits were obtained.

④Handling Standards relating to Credit Recognition for Department of Management courses taken by Students who changed Faculty/Department

A maximum of 20 credits are allocated for credit recognition for Department of Economics courses obtained by students before they changed Faculty/Department

⑤Course Numbering

Numbering shown in the list of assigned courses refer to the following. For information about numbering, refer to p.24 in the Handbook.

Field (alphabets)	Field (English)	Field (Japanese)
ECN	Economics	経済学
MAN	Management	経営学
ACC	Accounting	会計学
MRK	Marketing	マーケティング
MMI	Miscellaneous	経営学専攻共通

4. Early graduation

①Department of Management Early Graduation System

Early graduation refers to an enrollment period of at least 3 years (excluding periods of absence) and graduating at the end of the 3rd year or at the end of the Autumn Semester in the 4th year, upon completion of prescribed procedures (hereinafter referred to as "graduation in September of the 3rd year" or "graduation in March of the 4th

year”, respectively).

② In order to graduate early, all of the following requirements must be fulfilled.

- (1) The student must wish to graduate early.
- (2) At the time of early graduation, the student must have obtained all the credits for prescribed courses necessary for graduation.
- (3) The Grade Point Average (hereafter referred to as “the GPA”) for the total number of credits obtained must be 3.5 or more at the time of early graduation. GPA is calculated based on Sophia University Article 55.

③ When requesting early graduation, it is necessary to apply for early graduation registration.

- (1) In order to apply for early graduation registration, it is necessary to satisfy the following requirements:
 - a) Upon completion of the 2nd year, students are required to obtain at least 62 credits from Sophia University that count toward graduation.
 - b) The GPA for the abovementioned number of credits obtained is 3.0 or above.
- (2) The procedures for registering a request for early graduation are as follows:
 - a) Students are required to receive an Application for Early Graduation Registration in the predetermined format at the Department of Management Office.
 - b) After receiving an approval seal/signature from your seminar supervisor (hereinafter referred to as the “supervisor”. If you are not taking a seminar, receive a seal/signature from the Chairperson), submit the form to the Chairperson by the submission deadline.
- (3) After registering a request for early graduation, it is necessary to receive course guidance from your supervisor, report your academic progress to the supervisor regularly and receive appropriate guidance.

④ Changes to the graduation period and withdrawal of early graduation registration will be carried out as follows:

- (1) To alter the period of a request for early graduation, it is necessary to receive an approval seal/signature from your supervisor on the prescribed Notice of Changes to Period of Request for Early Graduation, and submit it to the Chairperson by the submission deadline.
- (2) To withdraw early graduation registration, it is necessary to receive an approval seal/signature from your supervisor on the prescribed Notice of Withdrawal of Registration of Request for Early Graduation, and submit it to the Chairperson by the deadline.

⑤ If a student wishing to graduate in September of the 3rd year as prescribed subsequently withdraws early graduation registration, he or she may register for early graduation in March of the 4th year in September of the 4th year provided that the Chairperson considers that special circumstances exist. If a student wishes to reregister, it is necessary to receive authorization from the Chairperson in advance and submit a re-application for Early Graduation Registration to the Chairperson.

For details, inquire at the Department of Management Office (Room 2-1115a, 11th Floor, Building No. 2)

Documents to be Submitted	Submission Period	
Application for Early Graduation Registration	September of the 3 rd year	
Re-Application for Early Graduation Registration	March of the 4 th year	
Notice of Changes to Period of Request for Early Graduation	By the last day of the course registration period in the Autumn Semester of the 3rd year	
Notice of Withdrawal of Registration of Request for Early Graduation	In the case of cancellation of graduation in March of the 3rd year	Suspension period of 4th quarter courses in the Autumn Semester of the 3rd year
	In the case of cancellation of graduation in September of the 4th year	Suspension period of 2nd quarter courses in the Spring Semester of the 4th year

5. Distribution of Required Credits

【For students who entered from 2022】Department of Management

○ General Studies: University-Wide General Studies (26 credits)

	1st Year		2nd Year		3rd Year		4th Year	
	Autumn Semester course title	Spring Semester course title	Autumn Semester course title	Spring Semester course title	Autumn Semester course title	Spring Semester course title	Autumn Semester course title	Spring Semester course title
Compulsory	8 cr	2						
Compulsory Electives	6 cr		2					
Electives	12cr							

Studies in Christian Humanism: 1 Critical Thinking & Discussion
 Liberal Arts of the Body Science: 1 Overview of Data Science
 Thinking about Issues, Perspectives and Positionality: 2

Studies in Christian Humanism: 2
 Advanced General Education Courses: 2
 SPSP Common Core(Theme Based): 4
 SPSP Common Core(Theme Based): 4
 First Year Lecture in/about Sustainable Futures: 4
 Third Year Seminar for Sustainable Futures: 2

- General Studies Elective Courses taught in English
 - First-year students may take General Studies Elective Courses up to 4 credits each semester
 - Language(s): up to 8 cr※1,3
 - Credits earned in excess of 6 credits in Compulsory Electives will be counted into Electives.

○ Language (4 credits)

	1st Year		2nd Year		3rd Year		4th Year	
	Autumn Semester course title	Spring Semester course title	Autumn Semester course title	Spring Semester course title	Autumn Semester course title	Spring Semester course title	Autumn Semester course title	Spring Semester course title
Compulsory	4 cr	2						

Academic Writing 1: 2, Academic Writing 2: 2

○ Specialized Education (94 cr)

	1st Year		2nd Year		3rd Year		4th Year	
	Autumn Semester course title	Spring Semester course title	Autumn Semester course title	Spring Semester course title	Autumn Semester course title	Spring Semester course title	Autumn Semester course title	Spring Semester course title
Compulsory	4 cr	2						
Compulsory Elective	46 cr	2						
Electives	42 cr							

Introduction to Management 1: 2, Introduction to Management 2: 2, Academic Presentations: 2
 Major Core (Compulsory Electives) Methodology/General, Category B: Minimum requirement credits is 4 cr. up to 42 cr
 Major Core (Compulsory Electives) Specialized, Category B: up to 42 cr
 Management Department Japanese Track's Compulsory Electives Course(s)(選択必修) only, up to 12cr ※1,2,3,4
 SE Electives, Category C: up to 42 cr
 The excess credits of Major Core (Compulsory Elective), Category B: up to 42 cr
 Management Department Japanese Track the excess credits of Compulsory Electives (選択必修) and Electives (選択) Course(s): up to 24 cr ※1,2,3,4
 FLA course(s) with course numbers starting with "IBE": up to 42 cr
 Language(s): up to 4 cr ※1,5
 Up to 12 credits in total:
 - Other Faculty/Department Course(s) ※1
 - Course(s) for Teacher & Curator Certification with course numbers starting with 62, except "Teaching Practice 1, 2, 3, 教育実習1, 2, 3," and "Museum Curator Field Work 1, 2 (博物館実習1, 2)"※1
 - SAIMS Program course(s)
 - DATA-DRIVEN AND STRATEGIC MANAGEMENT(データ活用と経営戦略): course number 099425, BUSINESS DATA ANALYSIS THEORY(ビジネスデータ分析理論): course number 099514 ※1

※1 No more than 24 credits of courses taught in Japanese in total

※2 "BUSINESS IN ENGLISH (BUSINESS COMMUNICATION STRATEGY)"(経営英語(Business Communication Strategy)), "BUSINESS IN ENGLISH 1(経営英語 I)", "BUSINESS IN ENGLISH 2(経営英語 II)", "BUSINESS IN ENGLISH (INTERNATIONAL BUSINESS)"(経営英語(International Business)) offered in Management department's Japanese Track(E) are not included in graduation requirements.

※3 Language Courses offered by CLER in own Department's Japanese Track are not included in graduation requirements.

※4 If students expect to take Japanese Track "Seminar 1, 2, 3, 4(演習1,2,3,4)", it's necessary for students to pass their advisor's examinations in the Autumn semester of their second year.

※5 For details regarding Language courses, see p.117, "LANGUAGES (OTHER THAN ENGLISH)" and SPSP Language Courses chart

6. Specialized Education Courses

Please refer to All SPSF Course List (p.184~p.190) of the departments which offer the courses for detailed information.

Journalism: p.184 Education: p.185 Sociology: p.186 Economics: p.187 Management:p.188 Global Studies:p.189 Other departments:p.190

Category A : Major Core (Compulsory)

Registration CD	Course CD	Course title	Cr.	Semester offered	Instructor	Student Year	Course Offering Department
EMGS1001	468056	INTRODUCTION TO MANAGEMENT 1	2	AUT	TAKINISHI, Atsuko	1	Management
EMGS1002	468057	INTRODUCTION TO MANAGEMENT 2	2	Not Offered	Staff	1	Management

Category B : Major Core (Compulsory Electives)

【Methodology】

Registration CD	Course CD	Course title	Cr.	Semester offered	Instructor	Student Year	Course Offering Department
EMGS5038	468068	CHALLENGING FRONTLINE ISSUES IN GLOBAL BUSINESS	4	SPR Summer intensive & on-site practice	AMIKURA, Hisanaga	3~4	Management
HSCS1030	289202	QUANTITATIVE METHODS IN SOCIOLOGY	2	SPR		1	Sociology
HSCS2030	289203	QUALITATIVE METHODS IN SOCIOLOGY	2	AUT		2	Sociology
EECS1003	498017	INTRODUCTION TO STATISTICS	2	SPR		1	Economics
EECS1004	498009	INTRODUCTION TO DATA ANALYSIS	2	AUT		1	Economics

【General】

Registration CD	Course CD	Course title	Cr.	Semester offered	Instructor	Student Year	Course Offering Department
EMGS5001	468058	PRINCIPLES OF ACCOUNTING	2	AUT	TAKINISHI, Atsuko	1~4	Management
EMGS5032	468033	PRINCIPLES OF MANAGEMENT	2	AUT	KAPTURKIEWICZ, Agata	1~4	Management
EMGS5047	468039	PRINCIPLES OF MARKETING	2	AUT	JOHNS, Adam	1~4	Management
EMGS5004	468059	FINANCIAL ACCOUNTING 1	2	SPR	TAKINISHI, Atsuko	2~4	Management
EMGS5048	468040	MARKETING STRATEGY 1	2	SPR	TOGAWA, Taku	2~4	Management
EMGS5037	468052	STRATEGIC MANAGEMENT	2	SPR	KAPTURKIEWICZ, Agata	2~4	Management
HJNS1010	268801	COMMUNICATION 1	2	AUT		1~4	Journalism
HJNS5030	268813	MASS MEDIA 1	2	Not Offered		3~4	Journalism
HJNS5040	268814	MASS MEDIA 2	2	Not Offered		3~4	Journalism
HJNS5010	268811	INTERNATIONAL COMMUNICATION 1	2	AUT		2~4	Journalism
HJNS5020	268812	INTERNATIONAL COMMUNICATION 2	2	SPR		2~4	Journalism
HEDS1030	147003	EDUCATION AND INTERNATIONAL DEVELOPMENT	2	AUT		2~4	Education
HEDS1010	147000	INTRODUCTION TO COMPARATIVE EDUCATION	2	AUT		2~4	Education
HSCS1010	289200	PRINCIPLES OF SOCIOLOGY	2	AUT		1	Sociology
HSCS5030	289221	CONTEMPORARY SOCIAL PROBLEMS	2	SPR		2~4	Sociology
HSCS2010	289204	SOCIOLOGICAL THEORY 1	2	AUT		2	Sociology

Registration CD	Course CD	Course title	Cr.	Semester offered	Instructor	Student Year	Course Offering Department
HSCS2020	289205	SOCIOLOGICAL THEORY 2	2	SPR		2	Sociology
HSCS5010	289220	SOCIOLOGY OF HAPPINESS	2	AUT		2~4	Sociology
HSCS5020	288893	WORK AND EMPLOYMENT IN JAPAN	2	AUT		2~4	Sociology
HSCS5110	289224	SPECIAL TOPICS IN SOCIOLOGY 1	2	1Q		3~4	Sociology
HSCS5120	289225	SPECIAL TOPICS IN SOCIOLOGY 2	2	AUT		3~4	Sociology
EECS1002	498008	INTRODUCTION TO MACROECONOMICS	2	Not Offered		1	Economics
EECS1001	498007	INTRODUCTION TO MICROECONOMICS	2	AUT		1	Economics
BGSS1030	BGSS1030	INTRODUCTION TO AREA STUDIES	2	AUT		1	Global Studies
BGSS1010	BGSS1010	INTRODUCTION TO GLOBAL STUDIES	2	AUT		1	Global Studies
BGSS1020	BGSS1020	INTRODUCTION TO INTERNATIONAL RELATIONS	2	AUT		1	Global Studies

【Specialized】

Registration CD	Course CD	Course title	Cr.	Semester offered	Instructor	Student Year	Course Offering Department
EMGS5044	468036	CONSUMER BEHAVIOR 1	2	SPR	SUGITANI, Yoko	2~4	Management
EMGS5045	468037	CONSUMER BEHAVIOR 2	2	AUT	SUGITANI, Yoko	2~4	Management
EMGS5005	468060	FINANCIAL ACCOUNTING 2	2	AUT	TAKINISHI, Atsuko	2~4	Management
EMGS5041	468050	FUNDAMENTALS OF ACCOUNTING 1	2	Not Offered	WAKABAYASHI, Toshiaki	2~4	Management
EMGS5042	468051	FUNDAMENTALS OF ACCOUNTING 2	2	AUT	WAKABAYASHI, Toshiaki	2~4	Management
EMGS5050	468048	GLOBAL MARKETING 1	2	Not Offered	JOHNS, Adam	2~4	Management
EMGS5051	468049	GLOBAL MARKETING 2	2	1Q	JOHNS, Adam	2~4	Management
EMGS5039	468034	MANAGEMENT ACCOUNTING 1	2	Not Offered	Staff	2~4	Management
EMGS5040	468035	MANAGEMENT ACCOUNTING 2	2	Not Offered	Staff	2~4	Management
EMGS5049	468041	MARKETING STRATEGY 2	2	AUT	TOGAWA, Taku	2~4	Management
EMGS5035	468046	ORGANIZATIONAL BEHAVIOR	2	Not Offered	Staff	2~4	Management
EMGS5036	468047	ORGANIZATIONAL THEORY AND ANALYSIS	2	AUT	KAPTURKIEWICZ, Agata Teresa	2~4	Management
EMGS5043	408010	GLOBAL BRANDING	2	AUT	JOHNS, Adam	2~4	Management
EMGS5027	468062	INTERNATIONAL ACCOUNTING	2	SPR	TAKINISHI, Atsuko	3~4	Management
EMGS59313	468038	SPECIAL TOPICS IN MARKETING	2	2Q	JOHNS, Adam	2~4	Management
EMGS5052	468069	ENTREPRENEURSHIP 1	2	SPR	KAPTURKIEWICZ, Agata	2~4	Management
EMGS5053	468070	ENTREPRENEURSHIP 2	2	AUT	KAPTURKIEWICZ, Agata	2~4	Management
EMGS5054	468071	INNOVATION MANAGEMENT	2	Not Offered	KAPTURKIEWICZ, Agata	2~4	Management
EMGS5033	468044	SPECIAL TOPICS IN MANAGEMENT 1	2	AUT	SCUDDER, Dylan*	3~4	Management
EMGS5034	468045	SPECIAL TOPICS IN MANAGEMENT 2	2	SPR	KAPTURKIEWICZ, Agata	3~4	Management
EMGS5028	468063	RESEARCH SEMINAR IN MANAGEMENT 1	2	Not Offered	Staff	3~4	Management
EMGS5029	468064	RESEARCH SEMINAR IN MANAGEMENT 2	2	Not Offered	Staff	3~4	Management

Registration CD	Course CD	Course title	Cr.	Semester offered	Instructor	Student Year	Course Offering Department
EMGS5030	468065	RESEARCH SEMINAR IN MANAGEMENT 3	2	Not Offered	Staff	3~4	Management
EMGS5031	468066	RESEARCH SEMINAR IN MANAGEMENT 4	2	Not Offered	Staff	3~4	Management
EMGS5900	469000	BACHELOR'S THESIS	4	Not Offered	Staff	4	Management
EECS5018	498021	MATHEMATICS FOR ECONOMICS	2	AUT		1~4	Economics
EECS5019	498016	AFRICAN ECONOMY	2	Not Offered		2~4	Economics
EECS5001	402060	INTERNATIONAL ECONOMICS AND BUSINESS	2	AUT		2~4	Economics
EECS5004	402120	JAPANESE ECONOMY 1	2	SPR		2~4	Economics
EECS5027	498025	INTERMEDIATE MACROECONOMICS	2	AUT		2~4	Economics

Category C : SE Electives

Registration CD	Course CD	Course title	Cr.	Semester offered	Instructor	Student Year	Course Offering Department
HJNS5070	268817	REPORTING IN ENGLISH 1	2	Not Offered	Staff	3~4	Journalism
HJNS5080	268818	REPORTING IN ENGLISH 2	2	Not Offered	Staff	3~4	Journalism
HJNS5090	268819	REPORTING IN ENGLISH 3	2	Not Offered	Staff	3~4	Journalism
HEDS5030	147023	SPECIAL TOPICS IN EDUCATION 3: CURRENT ISSUES IN EDUCATION IN ASIA	2	AUT		2~4	Education
HSCS5060	289222	SOCIOLOGY OF FAMILIES	2	Not Offered		2~4	Sociology
HSCS5130	289226	ENVIRONMENTAL SOCIOLOGY	2	Not Offered		3~4	Sociology
EECS5008	402110	CONTEMPORARY ISSUES IN INTERNATIONAL DEVELOPMENT	2	SPR		2~4	Economics
EECS5025	402080	ENVIRONMENTAL AND NATURAL RESOURCE ECONOMICS	2	SPR		2~4	Economics
EECS5005	402090	GLOBAL ECONOMIC HISTORY	2	AUT		2~4	Economics
EECS5026	402100	GAME THEORY	2	AUT		2~4	Economics
EECS5007	467969	GLOBAL DEVELOPMENT GOALS	2	AUT		2~4	Economics
EECS5024	498010	INTERNATIONAL FINANCE	2	SPR		2~4	Economics
EECS5011	498014	POVERTY IN THE GLOBAL ECONOMY	2	2Q		2~4	Economics
EECS5020	498015	ASIAN ECONOMY	2	AUT		2~4	Economics
EECS5002	498024	PUBLIC ECONOMICS 1	2	SPR		2~4	Economics
EECS5030	498028	QUANTITATIVE ANALYSIS OF SOCIAL ISSUES	2	SPR		2~4	Economics
EECS5031	498029	ECONOMICS OF SOCIAL POLICY	2	AUT		2~4	Economics
BGSS3003	BGS20000	BASICS OF INTERNATIONAL COOPERATION B	2	SPR		2~4	Global Studies
BGSS3004	BGS20001	BASICS OF SOUTHEAST ASIAN STUDIES B	2	SPR		2~4	Global Studies
BGSS3000	BGS50201	GLOBALIZATION AND ECONOMICS 2	2	AUT		2~4	Global Studies
BGSS3001	BGS59700	INTERNATIONAL POLITICS: THEORY AND PRACTICE	2	AUT		2~4	Global Studies
BGSS3002	BGS59800	INTERNATIONAL ORGANIZATION: THEORY AND PRACTICE	2	SPR		2~4	Global Studies

Registration CD	Course CD	Course title	Cr.	Semester offered	Instructor	Student Year	Course Offering Department
BGSS3011	BGS20004	AFRICA'S DEVELOPMENT AID	2	AUT		3~4	Global Studies
BGSS3014	BGS20007	CONFLICT RESOLUTION B	2	AUT		3~4	Global Studies
BGSS3015	BGS59000	PEACE RESEARCH	2	Not Offered		3~4	Global Studies
BGSS3007	BGS57900	SOCIETY AND POLITICS IN SOUTH ASIA	2	AUT		3~4	Global Studies
BGSS3005	BGS58500	THEORY OF INTERNATIONAL POLITICS	2	AUT		3~4	Global Studies
BGSS4005	BGS57507	ADVANCED STUDIES (CONTEMPORARY SOCIETIES OF ASIA)	2	SPR		3~4	Global Studies
BGSS4004	BGS57508	ADVANCED STUDIES (CULTURES AND SOCIETIES OF ASIA)	2	SPR		3~4	Global Studies
BGSS4006	BGS57517	ADVANCED STUDIES (GLOBAL MIGRATION AND KOREANS IN JAPAN)	2	AUT		3~4	Global Studies
BGSS4001	BGS57516	ADVANCED STUDIES (INTERNATIONAL HUMAN RIGHTS)	2	SPR		3~4	Global Studies
BGSS4003	BGS57505	ADVANCED STUDIES (INTERNATIONAL ORGANIZATION B)	2	SPR		3~4	Global Studies
AIBE3200	IBE320	HUMAN RESOURCE MANAGEMENT	4	AUT		3~4	FLA
AIBE3110	IBE311	INTERMEDIATE MICROECONOMICS	4	AUT		3~4	FLA
AIBE3030	IBE303	MANAGEMENT INFORMATION SYSTEMS	4	AUT		3~4	FLA
AIBE3260	IBE326	MONEY AND BANKING	4	Not Offered		3~4	FLA
AIBE3320	IBE332	WOMEN AND MEN IN THE LABOR MARKET	4	AUT		3~4	FLA

Instructor's name with * = adjunct instructor

Department of Global Studies SPSF Curriculum

Education and Research Objectives

To equip students, through systematic study of courses divided broadly into the categories of international relations and area studies, with (1) understandings of globality, (2) understandings of locality, (3) proficiency in multiple languages (English and regional languages), and (4) negotiating skills grounded in ethical awareness.

Human Resource Development Objectives

To produce graduates (international public intellectuals) capable of addressing both positive and negative facets of globalization, and contributing to the development of a collaborative society in which all people of the world move forward in partnership.

Diploma policy

The Faculty of Global Studies sets standards for the skills and knowledge that students who aim to become international public intellectuals seeking to achieve a fair society that protects human dignity in the globalizing world today. Those who fulfill the graduation requirements shall be deemed to have acquired these qualities and will be awarded a diploma.

1. An interest in social security, conflicts, poverty, development, immigrants, refugees, global environment, etc. and the ability to explain why such issues need to be solved globally.
2. The ability to understand the approaches and overall theory of international relations studies and area studies and consider issues from both perspectives combined.
3. The ability to shape problem-solving methodology analyze the positive and negative aspects of globalization in line with concrete case studies, using basic theories and demonstrative methods.
4. The ability to select two areas from International Relations Studies and Area Studies as disciplinary specialties and set up a research subject combining the two disciplines selected and perform research.
5. The ability to engage in dialogue with various others who live in different parts of the world and to cooperate in solving problems for the creation of an inclusive society.

In addition to the above, the SPSF course sets the following abilities which students should acquire before graduation as common requirements across its six departments (Department of Journalism, Department of Education, Department of Sociology, Department of Economics, Department of Management, Department of Global Studies).

6. The ability to learn the basic knowledge on “Sustainable Futures,” to understand its importance, and to take action towards resolving challenges to the sustainable futures by drawing upon their academic discipline as well as from the other five disciplines in the SPSF course they learn.
7. The ability to understand and apply the interdisciplinary perspectives and methodologies, learned in their academic discipline and in the other five disciplines of the SPSF course, when addressing issues and presenting their ideas.

Curriculum policy

In accordance with the Diploma Policy, the Department of Global Studies constructs its curriculum with courses aligned with the following purposes:

1. To have students study Global Studies and the basics of International Relations and Area Studies that support it in lectures, and thus acquire core theories and methodologies as well as fundamental research skills and approaches. 【Course numbers 100-199】
2. To have students understand the dynamics of international politics and economy, and learn in lectures about the mechanism of international cooperation and civil society, and thus prepare for selecting their specialties 【Course numbers 200-299】
3. To have students learn about Asia, the Middle East and Africa, etc. from the perspectives of history, culture, politics, economics, etc. in lectures and thus prepare for selecting their specialties. 【Course numbers 200-299】
4. To have students select two areas from International Relations Studies and Area Studies as their disciplinary specialties and have them conceptualize and implement solutions to global issues through lectures, etc. 【Lecture Course numbers 300-499】
5. To have students actively set up individual research questions regarding globalization issues and present relevant

research results in academic papers and other clear forms. 【Self-motivated research: 200-299; Seminars: 400-499; Thesis and research: 400-499】

6. To have students acquire a supportive attitude toward the theme-based research of other individuals through small-group seminars where they can deepen mutual understanding through debate. 【Basic Seminar numbers 100-199; Seminars 400-499】
7. To have students enhance their proficiency of English, the language commonly spoken internationally, and to have them acquire multilingual skills by encouraging them to learn foreign languages other than English. 【Lecture Course number 200-】

In addition to the above, the SPSF course constructs its curriculum in the following manner, for the purpose of achieving the common diploma policy across the six departments:

8. To enable the students during the first year to acquire a basic knowledge on “Sustainable Futures” and the relating issues through the SPSF General Studies Courses, drawing on the perspectives of six disciplines. Based on the acquired knowledge, the students will be able to deepen their understanding in various challenges related to the sustainable futures through Elective Courses in the University-wide General Studies Courses, and they will be also able to learn about the approaches, contents, and methodologies of the different disciplines through Specialized Courses offered by each department.
9. To enable students to gradually gain knowledge of the different disciplines of each Department and also acquire a wide range of knowledge through the courses offered by other faculties and departments which have been designated to offer Elective Compulsory Courses or Elective Courses. Thus, the students will be able to acquire the various perspectives, contents, and methodologies, as well as comprehensive approaches from the courses.

1. Courses and Minimum Number of Credits Required for Graduation

【For students who entered from 2022】

General Studies (Zengaku Kyotsu Kamoku)

- | | |
|-----------------------|--|
| Compulsory: | 8 credits (Studies in Christian Humanism: For Others, With Others, Liberal Arts of the Body: 1 Credit, Critical Thinking & Discussion, Overview of Data Science, Thinking about Issues, Perspectives and Positionality: 2 Credits) |
| Compulsory electives: | 6 credits (Studies in Christian Humanism: 2 Credits, Advanced General Education Courses: 4 Credits (including SPSF Common Core: Theme Based "Third Year Seminar for Sustainable Futures" 2 credits) |
| Electives: | 12 credits
(including SPSF Common Core: Theme Based "First Year Lecture in/about Sustainable Futures" 4 credits) |

Language

- | | |
|-------------|--|
| Compulsory: | 4 credits (SPSF Common Core: Academic Writing 1&2) |
|-------------|--|

Specialized Education (Gakka Kamoku)

- | | |
|-------------|--|
| Compulsory: | 12 credits |
| Electives: | 82 credits (including SPSF Common Core: Academic Skills 2 credits, Core Category 2 52 credits) |

Total: 124 credits are required for graduation.

【For students who entered from 2020 to 2021】

General Studies (Zengaku Kyotsu Kamoku)

- | | |
|-----------------------|--|
| Compulsory: | 2 credits (Health and Physical Education: 2 credits) |
| Compulsory electives: | 4 credits (Studies in Christian Humanism) |
| Electives: | 20 credits (including SPSF Common Core: Theme Based "First Year Lecture in/about Sustainable Futures", "Third Year Seminar for Sustainable Futures (Advanced General Education course)" 6 credits) |

Language

- | | |
|-------------|--|
| Compulsory: | 4 credits (SPSF Common Core: Academic Writing 1&2) |
|-------------|--|

Specialized Education (Gakka Kamoku)

Compulsory: 12 credits

Electives: 82 credits (including SPSF Common Core: Academic Skills 4 credits, Core Category 2 52 credits)

Total: 124 credits are required for graduation.

※The above Course Classification Elective includes both Compulsory Electives and Electives, which are described on page 178 of the Distribution of Required Credits.

2. Distribution of Required Credits

Please see page 178

3. Major and Minor

There are 2 fields of study: International Relations and Area Studies. Students are required to choose one field as their Major and the other as their Minor.

4. Guidelines for Course Registration

① Language courses

(1) English

For information about the English Language course (SPSF Common Core (Academic Skills)), refer to p.115 of the Bulletin of Information.

(2) Languages other than English

Regardless of your Major or Minor, students are strongly advised to take courses in a language other than their native language (students whose native language is not Japanese are recommended to take Japanese Language Courses).

② Specialized Education courses

(1) Selecting your Major and Minor

Confirmation time and application method for your Major and Minor

[Application] Make an application on Loyola for your Major, Minor, your desired seminar and your research issue (250 words).

[Registration] Once your Major and Minor are confirmed, the Center for Academic Affairs will fix the registration prior to the course registration period in the Autumn Semester of the 3rd year. By doing so, the graduation requirements of each student will be confirmed.

[Change of Major]

- Change Procedure

a) Students who wish to change their Major can do so once in the course registration period in the Autumn Semester of the final year of enrollment only if they have an exceptional reason and provided they receive a decision from a faculty meeting. Students who request a change must receive approval from their seminar supervisor and submit the prescribed application to the Department Office approximately one month prior to the course registration period in the Autumn Semester of the final year. A change of Major will necessitate a change of Minor.

b) Credits for a seminar obtained prior to a change of Major may be included in credits necessary for graduation (allocated as Specialized Education Electives) but they may not be counted as the 4 seminar credits of Specialized Education Compulsory Electives. Consequently, it is necessary to obtain 4 credits from the Major after the change.

(2) Regarding course years: Students must comply with course years described in the Standard allocation list and the list of assigned courses. First year students cannot take courses in the 300 series and first year students and second year students cannot take courses in the 400 series.

(3) Course precautions

• SPSF students cannot take the 7 Compulsory (必修) Course(s) offered in own Department's Japanese Track (グローバル・スタディーズ入門、地域研究入門、国際関係論入門、グローバル・スタディーズ基礎演習、自主研究、演習 and 卒業論文.)

• In the case of Courses taught in Japanese, a total of 24 credits may be counted toward graduation. Specifically, credits earned may be applied to (1) language courses among Elective courses in General Studies, (2) Core Category 2 (Compulsory Electives) courses, and (3) FGS Electives in Specialized Education.

• If you want to take a courses taught in Japanese in the category of Specialized Education, choose courses from the following subject groups.

200-level: 学部基礎科目 (選択必修科目) 200シリーズ; GS = グローバル研究共通科目群, IR = 国際関係論共通科目群, AS = 地域研究共通科目群

300-level: 学部専門科目 (選択必修科目) 300シリーズ

400-level: 学部応用科目 (選択必修科目) 400シリーズ; IR = 国際政治論科目群、および市民社会・国際協力論科目群; AS = アジア研究科目群、および中東・アフリカ研究科目群

• If SPSF students take courses offered in FGS Japanese Track, which is incorporated from other departments, they will be included in the graduation requirement according to the course classification of the Japanese track.

(4) Independent Studies: At any stage from the 2nd year to the 4th year, 2 credits per semester (one credit per Quarter in the case of Quarter courses) can be obtained, making a maximum of 12 credits in six semesters.

[Registration]

- a) Students who wish to take this course are required to have an interview with a supervisor in the semester prior to commencing research and obtain permission for their research plan.
- b) Students are required to receive the seal of the supervisor on the prescribed application form and submit it to the department office during the course registration period in the semester in which they begin the course.
- c) Students are required to register for courses on Loyola during the course registration period in each semester.
- d) As a general rule, Independent Studies Quarter courses are targeted at students who are going to study abroad or who have studied abroad. Such students are required to register for courses in the Quarter immediately before they depart or immediately after they return.
- e) Independent Studies Quarter courses cannot be taken for 2 Quarters continuously.

(5) Seminars

- a) As a general rule, students are required to obtain 4 credits in the 3rd year. Students who cannot obtain all these credits in the 3rd year due to study abroad or absence from school are required to take courses in the 3rd and 4th years.
- b) Students are required to select either Seminar (International Relations) or Seminar (Area Studies), which are held in English, according to their Major.
- c) The major area of study is determined by the placement of the seminar course. Not all students can be placed in the seminar course of their first choice because of the limited number of students in the seminar courses. For this reason, your major and minor areas to be determined may not be areas to be as you requested.
- d) If more than 4 seminar credits are obtained, the extra credits up to 4 credits can be included in the 22 credits that should be obtained in the area of the student's Major. If you earn exceeding 8 seminar credits, the credits will be included as Electives.
- e) Seminar credits cannot be obtained by transferring credits obtained during study abroad.
- f) SPSF students cannot take seminars offered in Japanese, as a general rule (also not possible to take them as Electives).

[Application and Registration on Loyola]

- a) The application period is provided at the beginning of May in the 2nd year.
Application period: May 2 (Mon), 2022~May 5 (Wed) 23:59
- b) Students are required to apply for their Major, Minor and their research issue (250 words) on Loyola May in the 2nd year.
- c) Students are required to register their confirmed Major seminar without fail in the Autumn course registration period in the 3rd year.
- d) When withdrawing a seminar course (W), students are required to obtain the approval of the Chairperson.

(6) Bachelor's Thesis

As a general rule, students are required to register for Bachelor's Thesis 1 (2 credits) in the Autumn Semester of the 4th year and Bachelor's Thesis 2 (2 credits) in the Spring Semester of the 4th year on Loyola in the same way as other courses, and create a Thesis or a Project.

- a) A Thesis of approximately 6,000 words is required to be written in English.
- b) A Project is required to be a project other than a thesis that requires the same degree of intellectual activity as a) above.
- c) The submission of a Thesis will be accepted provided that 4 seminar credits are obtained or are expected to be obtained by the submission semester.
- d) P (Pass) and X (Fail) are used to evaluate Bachelor's Thesis 1.
- e) In the semester a student takes Bachelor's Thesis 1, he or she is required to submit a "Title Registration Form" (60~120 words) and a "Research Plan" (600 words or more) to the instructor in charge of the seminar.
- f) If a student cannot obtain credits for Bachelor's Thesis 1, he or she cannot take Bachelor's Thesis 2. However, if there is a special reason such as study abroad, a student may be allowed to take Bachelor's Thesis 1 and Bachelor's Thesis 2 simultaneously in one semester (prior approval by the Chairman is required).

As a general rule, in such a case, students who expect to graduate within 4 years can only do so if they participate in "Overseas Study (excluding absence from school)" in the Autumn Semester of the 4th year and take these courses simultaneously in the Spring Semester of the 4th year.

Students who take Bachelor's Thesis 1 and Bachelor's Thesis 2 simultaneously in one semester are required to consult each of their supervisors concerning the submission deadlines for the "Title Registration Form" and the "Research Plan."

- g) SPSF students cannot study for the Bachelor's Thesis (卒業論文・卒業研究) taught in Japanese.

(7) Courses in other faculties

A maximum of 26 credits (for students who entered from 2020 to 2021) or 28 credits (for students who entered from 2022) for FGS courses, Faculty of Foreign Studies courses, Faculty of Liberal Arts courses, Courses for Teacher & Curator Certification with course numbers starting with 62, except "Teaching Practice 1, 2, 3 (教育実習 1,2,3) and "Museum Curator Field Work 1, 2 (博物館実習) and Courses offered by CLER can be included in FGS Electives required for graduation. In the case of courses offered by other faculties and departments, a maximum of 8 credits may be counted toward graduation.

(8) Recognition and conversion of credits for courses obtained at other Universities

Refer to p.44 of the Bulletin of Information regarding Transfer of Credits Earned before Entering as a First year student and the Procedure for Transfer of Credits for students studying abroad.

(9) Courses that students from other faculties may not take

1. Students other than SPSF students cannot take the 100 series lecture courses.
2. Students from other faculties and departments cannot take the 400 series seminar courses.

(10) The Loyola Bulletin Board

A variety of application forms are posted on the Loyola Announcement Bulletin Board: Faculty and Department Office. Download and use them as needed.

5. Early Graduation System

1. Early graduation refers to an enrollment period of at least 3 years, and graduating at the end of the 3rd year or at the end of the Autumn Semester in the 4th year, upon completion of prescribed procedures. The former is referred to as graduation in September of the 3rd year and the latter graduation in March of the 4th year.
2. In order to graduate early, all of the following requirements must be fulfilled.
 - (1) The student must wish to graduate early.
 - (2) At the time of graduation, the student must have obtained all the credits for prescribed courses necessary for graduation.
 - (3) The Grade Point Average (hereafter referred to as "the GPA") for the total number of credits obtained must be 3.7 or more.
3. When requesting early graduation, it is necessary to apply for early graduation registration.

- (1) In order to apply for early graduation registration, it is necessary to obtain 80 credits or more (of which at least 62 must be obtained at Sophia University) that count toward graduation in prescribed courses by the end of the 2nd year. In addition, the GPA for the total number of credits obtained must be at least 3.7.
 - (2) A student who registers for early graduation must have taken 4 seminar credits by the time of graduation.
 - (3) A student wishing to graduate early must submit an Application for Early Graduation Registration to FGS office during the course registration period in the Autumn Semester of the 3rd year. On the Application, it is necessary to obtain the approval stamp of the instructor in charge of the seminar you will be attending.
 - (4) A student who registers for early graduation must consult the Chairperson or the instructor in charge of the seminar in advance and receive appropriate guidance. Also, the student must report the progress of his/her studies to the supervisor and receive guidance as required.
 - (5) A student who registers for early graduation may not as a general rule take a leave of absence.
4. For changes to the graduation period and withdrawal of early graduation registration, the following procedures must be followed:
- (1) In the special case of a student wishing to graduate in the end of the 3rd year, it is possible to change the time of early graduation. In this case, the approval stamp of the instructor in charge of the seminar must be affixed to the Notice of Changes to Period of Request for Early Graduation, and this form must be submitted to FGS office during the course registration period in the Spring Semester of the 3rd year.
 - (2) If a student who has registered for early graduation wishes to withdraw early graduation registration, the approval stamp of the instructor in charge of the seminar must be affixed to the Notice of Withdrawal of Registration of Request for Early Graduation, and this form must be submitted to FGS office by the date determined separately.
 - (3) When withdrawing early graduation application, courses completed in the 3rd year which would normally be taken in the 4th year will be included in the credits necessary for graduation.

Documents to be Submitted	Submission Period
Application for Early Graduation Registration	Course registration period in the Autumn Semester of the 3 rd year
Notice of Changes to Period of Request for Early Graduation	Course registration period in the Spring Semester of the 3 rd year
Notice of Withdrawal of Registration of Request for Early Graduation: the end of the 3 rd Year	Course registration period in the Spring Semester of the 3 rd year
Notice of Withdrawal of Registration of Request for Early Graduation: March of the 4 th Year	Course registration period in the Autumn Semester of the 4 th year

6. Distribution of Required Credits

【For students who entered from 2022】Department of Global Studies

O. General Studies: University-Wide General Studies (26 credits)

	1st Year		2nd Year		3rd Year		4th Year	
	Autumn Semester course title	Spring Semester course title	Autumn Semester course title	Spring Semester course title	Autumn Semester course title	Spring Semester course title	Autumn Semester course title	Spring Semester course title
Compulsory	8 cr Studies in Christian Humanism: For Others, With Others Liberal Arts of the Body Thinking about Issues, Perspectives and Positionality	2 cr Critical Thinking & Discussion Overview of Data Science						
Compulsory Electives	6 cr Studies in Christian Humanism Advanced General Education Courses SPSF Common Core (Theme Based)		2 cr Studies in Christian Humanism		Advanced General Education Courses			
Electives	12 cr First Year Lecture in/about Sustainable Futures General Studies Elective Courses taught in English First-year students may take General Studies Elective Courses up to 4 credits each semester Language(s): up to 8 cr ※1,2 Credits earned in excess of 6 credits in Compulsory Electives will be counted into Electives.	4 cr			2 cr Third Year Seminar for Sustainable Futures			

O. Language (4 credits)

	1st Year		2nd Year		3rd Year		4th Year	
	Autumn Semester course title	Spring Semester course title	Autumn Semester course title	Spring Semester course title	Autumn Semester course title	Spring Semester course title	Autumn Semester course title	Spring Semester course title
Compulsory	4 cr Academic Writing 1	2 cr Academic Writing 2						

O. Specialized Education (94 cr)

	1st Year		2nd Year		3rd Year		4th Year	
	Autumn Semester course title	Spring Semester course title	Autumn Semester course title	Spring Semester course title	Autumn Semester course title	Spring Semester course title	Autumn Semester course title	Spring Semester course title
Compulsory	2 cr Introduction to Global Studies	2 cr Introduction to International Relations	2 cr Academic Skills for Global Studies	2 cr			Bachelor's Thesis 1	2 cr Bachelor's Thesis 2
Compulsory Electives	2 cr Academic Presentations							
Electives	28 cr							

Up to 28 cr
 • Major Core Category 2 (The excess credits of Core Category 2)
 • FGS Electives
 • **Compulsory Elective (選択必修 Course(s) and Elective (選択) Course(s) offered in own Department's Japanese Track** ※1,3
 • FLA course(s)
 • FFL course(s); Courses taught in English only
 • **Language(s) ※1,2**
 • **Course(s) for Teacher & Curator Certification with course numbers starting with 62, except "Teaching Practice 1, 2, 3 (教育実習1, 2, 3)" and "Museum Curator Field Work 1, 2 (博物館実習1, 2)"** ※
 Up to 8 cr
 • **Other Faculty/Department Course(s) except FLA and FFL Courses taught in English** ※1,2

※1 No more than 24 credits of courses taught in Japanese in total.

※2 For details regarding Language courses, see p.117~123, "LANGUAGES (OTHER THAN ENGLISH)" and SPSF Language Courses chart. If you want to take a course taught in Japanese in the category of Specialized Education, choose courses from the following subject groups.

※3 200-level: 学部基礎科目 (選択必修科目) 200シリーズ / GS=グローバル研究共通科目群, IR=国際関係共通科目群, IR=地域研究共通科目群

300-level: 学部専門科目 (選択必修科目) 300シリーズ / 学部応用科目 (選択必修科目) 400シリーズ / IR=国際政治論科目群, および市民社会・国際協力論科目群, AS=アジア研究科目群, および中東・アフリカ研究科目群
 If more than 4 seminar credits are obtained, the extra credits up to 4 credits can be included in the 22 credits that should be obtained in the area of the student's Major. If you earn exceeding 8 seminar credits, the credits will be included as SE Electives.

【For students who entered from 2020 to 2021】Department of Global Studies

○ General Studies: University-Wide General Studies (26 credits)

	1st Year		2nd Year		3rd Year		4th Year	
	Autumn Semester course title	Spring Semester course title	Autumn Semester course title	Spring Semester course title	Autumn Semester course title	Spring Semester course title	Autumn Semester course title	Spring Semester course title
Compulsory Compulsory Electives	2 cr 4 cr	2	4					cr
Electives	First Year Lecture in/about Sustainable Futures 4		Third Year Seminar for Sustainable Futures (Advanced General Education course) 2					
	14 cr - General Studies Elective Courses taught in English - Language(s): up to 8 cr ※1,2							

○ Language (4 credits)

	1st Year		2nd Year		3rd Year		4th Year	
	Autumn Semester course title	Spring Semester course title	Autumn Semester course title	Spring Semester course title	Autumn Semester course title	Spring Semester course title	Autumn Semester course title	Spring Semester course title
Compulsory	4 cr	2	Academic Writing 2	2				

○ Specialized Education (94 cr)

	1st Year		2nd Year		3rd Year		4th Year		
	Autumn Semester course title	Spring Semester course title	Autumn Semester course title	Spring Semester course title	Autumn Semester course title	Spring Semester course title	Autumn Semester course title	Spring Semester course title	
Compulsory	12 cr	2	Academic Skills for Global Studies	2			Bachelor's Thesis 1	2	
	2	2	Critical Thinking & Discussion	2			Bachelor's Thesis 2	2	
Compulsory Electives	4 cr	2							
	52 cr								
Courses taught in Japanese: Own Department's Compulsory Elective Course(s) ※1,3 ※4 Seminar 1 2 Seminar 2									
Electives	Up to 26 cr		200-level GS ※1,3		6 cr				
	- Major Core Category 2 (The excess credits of Core Category 2) - FGS Electives - Compulsory Elective Course(s) and Elective Course(s) offered in own Department's Japanese Track ※1,3 - FLA course(s) - FFL course(s); Courses taught in English only - Language(s) ※1,2 - Course(s) for Teacher & Curator Certification with course numbers starting with 62, except "Teaching Practice 1, 2, 3 (教育実習1, 2, 3)" and "Museum Curator Field Work 1, 2 (博物館実習1, 2)" ※		200-level IR ※1,3		4 cr				
				200-level AS ※1,3		4 cr			
				Major 300-400 level (IR or AS) ※1,3		22 cr			
				Minor 300-400 level (IR or AS) ※1,3		12 cr			

※1 No more than 24 credits of courses taught in Japanese in total.

※2 For details regarding Language courses, see p.117~123, "LANGUAGES (OTHER THAN ENGLISH)" and SPSF Language Courses chart.

※3 If you want to take a course taught in Japanese in the category of Specialized Education, choose courses from the following subject groups.

200-level: 学部基礎科目(選択必修科目) 200シリーズ / GS-グローバル研究共通科目群, IR=国際関係共通科目群, AS=地域研究共通科目群

300-level: 学部専門科目(選択必修科目) 300シリーズ, 400-level: 学部応用科目(選択必修科目) 400シリーズ / IR=国際政治論科目群, および市民社会・国際協力論科目群, AS=アジア研究科目群, および中東・アフリカ研究科目群

※4 If more than 4 seminar credits are obtained, the extra credits up to 4 credits can be included in the 22 credits that should be included in the area of the student's Major. If you earn exceeding 8 seminar credits, the credits will be included as SE Electives.

7.Specialized Education Courses

Please refer to All SPSF Course List (p.184~p.190) of the departments which offer the courses for detailed information.

Journalism: p.184 Education: p.185 Sociology: p.186 Economics: p.187 Management:p.188 Global Studies:p.189 Other departments:p.190

Core Category 1 (Compulsory)

Registration CD	Course CD	Course title	Cr.	Semester offered	Instructor	Student Year	Course Offering Department
BGSS1010	BGSS1010	INTRODUCTION TO GLOBAL STUDIES	2	AUT	MARUI, Masako	1	Global Studies
BGSS1020	BGSS1020	INTRODUCTION TO INTERNATIONAL RELATIONS	2	AUT	KISHIKAWA, Takeshi	1	Global Studies
BGSS1030	BGSS1030	INTRODUCTION TO AREA STUDIES	2	AUT	FUKUTAKE, Shintaro	1	Global Studies
BGSS1040	BGSS1040	ACADEMIC SKILLS FOR GLOBAL STUDIES	2	AUT	KOBAYASHI, Ayako	2	Global Studies
BGSS9000	BGSS9000	BACHELOR'S THESIS 1	2	Not Offered	Staff	4	Global Studies
BGSS9010	BGSS9010	BACHELOR'S THESIS 2	2	Not Offered	Staff	4	Global Studies

Core Category 2 (Compulsory Electives)

【Seminar】

Registration CD	Course CD	Course title	Cr.	Semester offered	Instructor	Student Year	Course Offering Department
BGSS6000	BGSS6000	SEMINAR (INTERNATIONAL RELATIONS) 1	2	AUT	KOBAYASHI, Ayako	3	Global Studies
BGSS6001	BGSS6001	SEMINAR (INTERNATIONAL RELATIONS) 2	2	Not Offered	KOBAYASHI, Ayako	3	Global Studies
BGSS6010	BGSS6010	SEMINAR(AREA STUDIES) 1	2	AUT	AUGUSTINE, Sali	3	Global Studies
BGSS6011	BGSS6011	SEMINAR(AREA STUDIES) 2	2	Not Offered	AUGUSTINE, Sali	3	Global Studies

【GS100-200】

Registration CD	Course CD	Course title	Cr.	Semester offered	Instructor	Student Year	Course Offering Department
BGSS3000	BGS50201	GLOBALIZATION AND ECONOMICS 2	2	AUT	TAKASHIMA, Ryo	1~2	Global Studies
BGSS3001	BGS59700	INTERNATIONAL POLITICS: THEORY AND PRACTICE	2	AUT	KOBAYASHI, Ayako	1~2	Global Studies
BGSS3002	BGS59800	INTERNATIONAL ORGANIZATION: THEORY AND PRACTICE	2	SPR	KOBAYASHI, Ayako	1~2	Global Studies
HJNS1010	268801	COMMUNICATION 1	2	AUT		1	Journalism
HJNS5010	268811	INTERNATIONAL COMMUNICATION 1	2	AUT		2~4	Journalism
HJNS5020	268812	INTERNATIONAL COMMUNICATION 2	2	Not Offered		2~4	Journalism
HEDS1050	147001	COMPARATIVE EDUCATION IN ASIA	2	SPR		1~2	Education
HEDS1040	147004	CURRICULUM AND INSTRUCTION	2	SPR		1~2	Education
HEDS1030	147003	EDUCATION AND INTERNATIONAL DEVELOPMENT	2	AUT		1~2	Education
HEDS1020	147002	INTERNATIONAL EDUCATION	2	SPR		1~2	Education
HEDS1010	147000	INTRODUCTION TO COMPARATIVE EDUCATION	2	AUT		1~2	Education
HEDS5010	147021	SPECIAL TOPICS IN EDUCATION 1: PHILOSOPHY OF EDUCATION	2	AUT		1~4	Education
HEDS5020	147022	SPECIAL TOPICS IN EDUCATION 2: SOCIOLOGY OF EDUCATION	2	Not Offered		1~4	Education
HSCS1010	289200	PRINCIPLES OF SOCIOLOGY	2	AUT		1	Sociology
HSCS1030	289202	QUANTITATIVE METHODS IN SOCIOLOGY	2	SPR		1	Sociology
HSCS5030	289221	CONTEMPORARY SOCIAL PROBLEMS	2	SPR		2~4	Sociology
HSCS2030	289203	QUALITATIVE METHODS IN SOCIOLOGY	2	AUT		2	Sociology

Registration CD	Course CD	Course title	Cr.	Semester offered	Instructor	Student Year	Course Offering Department
HSCS5040	288807	SOCIAL CHANGE IN POSTWAR JAPAN	2	Not Offered		2~4	Sociology
HSCS2010	289204	SOCIOLOGICAL THEORY 1	2	AUT		2	Sociology
HSCS2020	289205	SOCIOLOGICAL THEORY 2	2	SPR		2	Sociology
HSCS5010	289220	SOCIOLOGY OF HAPPINESS	2	AUT		2~4	Sociology
EECS1002	498008	INTRODUCTION TO MACROECONOMICS	2	Not Offered		1	Economics
EECS1001	498007	INTRODUCTION TO MICROECONOMICS	2	AUT		1	Economics
EECS1003	498017	INTRODUCTION TO STATISTICS	2	SPR		1	Economics
EECS5008	402110	CONTEMPORARY ISSUES IN INTERNATIONAL DEVELOPMENT	2	SPR		2~4	Economics
EECS5007	467969	GLOBAL DEVELOPMENT GOALS	2	AUT		2~4	Economics
EECS5005	402090	GLOBAL ECONOMIC HISTORY	2	Not Offered		2~4	Economics
EECS1004	498009	INTRODUCTION TO DATA ANALYSIS	2	AUT		1	Economics
EECS5011	498014	POVERTY IN THE GLOBAL ECONOMY	2	2Q		2~4	Economics
EECS5028	498026	ACTIVE LEARNING SEMINAR 1	2	SPR		2~4	Economics
EECS5029	498027	ACTIVE LEARNING SEMINAR 2	2	AUT		3~4	Economics
EMGS5050	468048	GLOBAL MARKETING 1	2	Not Offered		2~4	Management
EMGS5051	468049	GLOBAL MARKETING 2	2	1Q		2~4	Management

【AS200】

Registration CD	Course CD	Course title	Cr.	Semester offered	Instructor	Student Year	Course Offering Department
BGSS3004	BGS20001	BASICS OF SOUTHEAST ASIAN STUDIES B	2	SPR	KUSHIMOTO, Hiroko	1~2	Global Studies
EECS5019	498016	AFRICAN ECONOMY	2	Not Offered		2~4	Economics
EECS5020	498015	ASIAN ECONOMY	2	AUT		2~4	Economics
EECS5004	402120	JAPANESE ECONOMY 1	2	AUT		2~4	Economics
GSP21380	GSP21380	JAPANOLOGY (LITERATURE) A2	2	SPR		2~4	CLEL
GSP21390	GSP21390	JAPANOLOGY (LITERATURE) B2	2	AUT		2~4	CLEL
GSP21440	GSP21440	JAPANOLOGY (TOURISM) A2	2	SPR		2~4	CLEL
GSP21441	GSP21440	JAPANOLOGY (TOURISM) A2	2	SPR		2~4	CLEL
GSP21450	GSP21450	JAPANOLOGY (TOURISM) B2	2	AUT		2~4	CLEL
GSP21451	GSP21450	JAPANOLOGY (TOURISM) B2	2	AUT		2~4	CLEL

【AS300-400】

Registration CD	Course CD	Course title	Cr.	Semester offered	Instructor	Student Year	Course Offering Department
BGSS3011	BGS20004	AFRICA'S DEVELOPMENT AID	2	AUT	TSHIKENDWA, Matadi Ghislain	2~4	Global Studies
BGSS3012	BGS20005	ANTHROPOLOGY OF SUFFERINGS AND HOPES IN AFRICA	2	AUT	TSHIKENDWA, Matadi Ghislain	2~4	Global Studies
BGSS3016	BGS59500	ASIAN POLITICS	2	SPR	KOBAYASHI, Ayako	2~4	Global Studies
BGSS3008	BGS58300	CONTEMPORARY SOCIETIES OF THE MIDDLE EAST	2	AUT	TSUJIGAMI, Namie	2~4	Global Studies
BGSS3010	BGS58100	LIFE AND CULTURE IN AFRICA	2	AUT	TODA, Mikako	2~4	Global Studies
BGSS3017	BGS20008	MODERN HISTORY OF THE MIDDLE EAST B	2	AUT	YAMAGUCHI, Akihiko	2~4	Global Studies
BGSS3007	BGS57900	SOCIETY AND POLITICS IN SOUTH ASIA	2	AUT	AUGUSTINE, Sali	2~4	Global Studies

Registration CD	Course CD	Course title	Cr.	Semester offered	Instructor	Student Year	Course Offering Department
BGSS4005	BGS57507	ADVANCED STUDIES (CONTEMPORARY SOCIETIES OF ASIA)	2	SPR	VARGHESE, Mathew*	3~4	Global Studies
BGSS4004	BGS57508	ADVANCED STUDIES (CULTURES AND SOCIETIES OF ASIA)	2	SPR	YONENO-REYES, Michivo*	3~4	Global Studies
BGSS4006	BGS57517	ADVANCED STUDIES (GLOBAL MIGRATION AND KOREANS IN JAPAN)	2	AUT	KWON, Hyang Suk	3~4	Global Studies
APOL3030	POL303	JAPANESE FOREIGN AND SECURITY POLICY	4	SPR		3~4	FLA
AANT3650	ANT365	KOREAN STUDIES: NORTH AND SOUTH	4	Not Offered		3~4	FLA
HHT55710	170470	LEC. IN HIST. (MODERN JAPAN)	2	AUT		3~4	History

【IR200】

Registration CD	Course CD	Course title	Cr.	Semester offered	Instructor	Student Year	Course Offering Department
BGSS3003	BGS20000	BASICS OF INTERNATIONAL COOPERATION B	2	SPR	OHASHI, Chiho*	1~2	Global Studies
BGSS3013	BGS20006	BASICS OF THEORIES OF CIVIL SOCIETY B	2	AUT	WEISS, Tobias	1~2	Global Studies
HEDS5030	147023	SPECIAL TOPICS IN EDUCATION 3: CURRENT ISSUES IN EDUCATION IN ASIA	2	AUT		1~4	Education
HEDS5040	147024	SPECIAL TOPICS IN EDUCATION 4: EDUCATION FOR CRITICAL ACTION IN THE ANTHROPOCENE	2	AUT		1~4	Education
HEDS5050	147025	SPECIAL TOPICS IN EDUCATION 5: TBA	2	Not Offered		1~4	Education
HSCS5050	284930	SOCIOLOGY OF GLOBALIZATION	2	SPR		2~4	Sociology
EECS5030	498028	QUANTITATIVE ANALYSIS OF SOCIAL ISSUES	2	SPR		2~4	Economics
EECS5031	498029	ECONOMICS OF SOCIAL POLICY	2	AUT		2~4	Economics
EMGS5044	468036	CONSUMER BEHAVIOR 1	2	SPR		2~4	Management
EMGS5045	468037	CONSUMER BEHAVIOR 2	2	AUT		2~4	Management
EMGS5048	468040	MARKETING STRATEGY 1	2	SPR		2~4	Management
EMGS5049	468041	MARKETING STRATEGY 2	2	AUT		2~4	Management
EMGS5035	468046	ORGANIZATIONAL BEHAVIOR	2	Not Offered		2~4	Management
EMGS5036	468047	ORGANIZATIONAL THEORY AND ANALYSIS	2	AUT		2~4	Management
EMGS5037	468052	STRATEGIC MANAGEMENT	2	SPR		2~4	Management
EMGS5052	468069	ENTREPRENEURSHIP 1	2	SPR		2~4	Management
EMGS5053	468070	ENTREPRENEURSHIP 2	2	AUT		2~4	Management
EMGS5054	468071	INNOVATION MANAGEMENT	2	Not Offered		2~4	Management

【IR300-400】

Registration CD	Course CD	Course title	Cr.	Semester offered	Instructor	Student Year	Course Offering Department
BGSS3014	BGS20007	CONFLICT RESOLUTION B	2	AUT	KOBAYASHI, Ayako	2~4	Global Studies
BGSS3006	BGS20002	EDUCATION FOR MINORITIES IN JAPAN	2	AUT	TOKUNAGA, Tomoko*	2~4	Global Studies
BGSS3015	BGS59000	PEACE RESEARCH	2	SPR	KOBAYASHI, Ayako	2~4	Global Studies
BGSS3005	BGS58500	THEORY OF INTERNATIONAL POLITICS	2	AUT	SUZUKI, Kazutoshi	2~4	Global Studies
BGSS4002	BGS25000	ADVANCED STUDIES (DEMOCRACY AND CONFLICT)	2	SPR	NAKAUCHI, Masataka	3~4	Global Studies
BGSS4001	BGS57516	ADVANCED STUDIES (INTERNATIONAL HUMAN RIGHTS)	2	SPR	KOBAYASHI, Ayako	3~4	Global Studies
BGSS4003	BGS57505	ADVANCED STUDIES (INTERNATIONAL ORGANIZATION B)	2	SPR	OGISU, Takayo	3~4	Global Studies
HJNS5030	268813	MASS MEDIA 1	2	Not Offered		3~4	Journalism
HJNS5040	268814	MASS MEDIA 2	2	Not Offered		3~4	Journalism

Registration CD	Course CD	Course title	Cr.	Semester offered	Instructor	Student Year	Course Offering Department
HJNS5070	268817	REPORTING IN ENGLISH 1	2	Not Offered		3~4	Journalism
HJNS5080	268818	REPORTING IN ENGLISH 2	2	Not Offered		3~4	Journalism
HJNS5090	268819	REPORTING IN ENGLISH 3	2	Not Offered		3~4	Journalism
HJNS5050	268815	ETHICS OF MASS COMMUNICATION 1	2	Not Offered		3~4	Journalism
HJNS5060	268816	ETHICS OF MASS COMMUNICATION 2	2	Not Offered		3~4	Journalism
HSCS5130	289226	ENVIRONMENTAL SOCIOLOGY	2	Not Offered		3~4	Sociology
HSCS5110	289224	SPECIAL TOPICS IN SOCIOLOGY 1	2	1Q		3~4	Sociology
HSCS5120	289225	SPECIAL TOPICS IN SOCIOLOGY 2	2	AUT		3~4	Sociology
EMGS5038	468008	CHALLENGING FRONTLINE ISSUES IN GLOBAL BUSINESS	4	SPR Summer intensive & on-site practice		3~4	Management
EMGS5043	468010	GLOBAL BRANDING	2	AUT		2~4	Management
LAW69000	333306	COMPARATIVE POLITICS	2	AUT		3~4	Law
LAW69300	333307	INTERNATIONAL INSTITUTIONS AND WORLD ORDER	2	AUT		3~4	Law
LAW68200	338010	INTERNATIONAL POLITICAL ECONOMY	2	SPR		3~4	Law
LAW52301	337503	JAPANESE POLITICS IN GLOBAL PERSPECTIVES	2	AUT		3~4	Law

SE Electives

Registration CD	Course CD	Course title	Cr.	Semester offered	Instructor	Student Year	Course Offering Department
BGSS5000	BGSS5000	INDEPENDENT STUDIES 1	2	AUT	Staff※	2	Global Studies
BGSS5001	BGSS5001	INDEPENDENT STUDIES 2	2	SPR	Staff※	2	Global Studies
BGSS5010	BGSS5010	INDEPENDENT STUDIES 2a	1	1Q	Staff※	2	Global Studies
BGSS5011	BGSS5011	INDEPENDENT STUDIES 2b	1	2Q	Staff※	2	Global Studies
BGSS5002	BGSS5002	INDEPENDENT STUDIES 3	2	AUT	Staff※	3	Global Studies
BGSS5003	BGSS5003	INDEPENDENT STUDIES 4	2	Not Offered	Staff※	3	Global Studies
BGSS5012	BGSS5012	INDEPENDENT STUDIES 4a	1	Not Offered	Staff※	3	Global Studies
BGSS5013	BGSS5013	INDEPENDENT STUDIES 4b	1	Not Offered	Staff※	3	Global Studies
BGSS5004	BGSS5004	INDEPENDENT STUDIES 5	2	Not Offered	Staff※	4	Global Studies
BGSS5005	BGSS5005	INDEPENDENT STUDIES 6	2	Not Offered	Staff※	4	Global Studies
BGSS5014	BGSS5014	INDEPENDENT STUDIES 6a	1	Not Offered	Staff※	4	Global Studies
BGSS5015	BGSS5015	INDEPENDENT STUDIES 6b	1	Not Offered	Staff※	4	Global Studies

Instructor's name with * = adjunct instructor

※Instructors of Faculty of Global Studies 2/2a/2b (except Sawae, Tanaka, Watanabe, Ogisu)

※Instructors of Faculty of Global Studies 1/3 (except Inaba, Maki, Ogisu)

All SPSF Course List — Department of Journalism

- Instructor: Instructor's name with * = adjunct instructor
- Attendees: "*" in Attendees, the course is only open to SPSF students, in case of "*" with "Department's Name, SPSF only" in Remarks, the course is only open to Department's SPSF students.
Courses with blank are open to SPSF students and other Faculty/Department students.
- Remarks: [] = Lottery Courses. Number in brackets is the capacity.

Registration CD	Course CD	Course title	Cr.	Semester offered	Instructor	Numbering	Attendees	Remarks	Journalism	Education	Sociology	Journalism	Economics	Management	Global Studies
HJNS1010	268801	COMMUNICATION 1	2	AUT	KUNIEDA, Tomoki	JRN101-19e00			○	○	○	○	○	○	○
HJNS1020	268802	SEMINAR 1 (MEDIA RESEARCH)	2	SPR	ARUN, D Souza	JRN102-19e00			○						
HJNS2011	268803	SEMINAR 2A	1	AUT	KUNIEDA, Tomoki	JRN203-19e00			○						
HJNS2012	268803	SEMINAR 2A	1	AUT	ARUN, D Souza	JRN203-19e00			○						
HJNS2021	268804	SEMINAR 2B	1	Not Offered	KUNIEDA, Tomoki	JRN204-19e00			○						
HJNS2022	268804	SEMINAR 2B	1	Not Offered	ARUN, D Souza	JRN204-19e00			○						
HJNS3011	268805	SEMINAR 3A	1	Not Offered	KUNIEDA, Tomoki	JRN303-19e00			○						
HJNS3012	268805	SEMINAR 3A	1	Not Offered	ARUN, D Souza	JRN303-19e00			○						
HJNS3021	268806	SEMINAR 3B	1	Not Offered	KUNIEDA, Tomoki	JRN304-19e00			○						
HJNS3022	268806	SEMINAR 3B	1	Not Offered	ARUN, D Souza	JRN304-19e00			○						
HJNS4011	268807	SEMINAR 4A	1	Not Offered	KUNIEDA, Tomoki	JRN403-19e00			○						
HJNS4012	268807	SEMINAR 4A	1	Not Offered	ARUN, D Souza	JRN403-19e00			○						
HJNS4021	268808	SEMINAR 4B	1	Not Offered	KUNIEDA, Tomoki	JRN404-19e00			○						
HJNS4022	268808	SEMINAR 4B	1	Not Offered	ARUN, D Souza	JRN404-19e00			○						
HJNS4030	268809	BACHELOR'S THESIS A	2	Not Offered	Staff	JRN405-19e00			○						
HJNS4040	268810	BACHELOR'S THESIS B	2	Not Offered	Staff	JRN405-19e00			○						
HJNS5010	268811	INTERNATIONAL COMMUNICATION 1	2	AUT	HWANG, Seongbin	JRN201-19e00		◇	○	○	○	○	○	○	○
HJNS5020	268812	INTERNATIONAL COMMUNICATION 2	2	Not Offered	HWANG, Seongbin	JRN202-19e00		◇	○	○	○	○	○	○	○
HJNS5030	268813	MASS MEDIA 1	2	Not Offered	KUNIEDA, Tomoki	JRN301-19e00		◇	○	○	○	○	○	○	○
HJNS5040	268814	MASS MEDIA 2	2	Not Offered	KUNIEDA, Tomoki	JRN302-19e00		◇	○	○	○	○	○	○	○
HJNS5070	268817	REPORTING IN ENGLISH 1	2	Not Offered	Staff	JRN340-19e00			○	○	○	○	○	○	○
HJNS5080	268818	REPORTING IN ENGLISH 2	2	Not Offered	Staff	JRN341-19e00			○	○	○	○	○	○	○
HJNS5090	268819	REPORTING IN ENGLISH 3	2	Not Offered	Staff	JRN342-19e00			○	○	○	○	○	○	○
HJNS5050	268815	ETHICS OF MASS COMMUNICATION 1	2	Not Offered	Staff	JRN401-19e00		◇	○	○	○	○	○	○	○
HJNS5060	268816	ETHICS OF MASS COMMUNICATION 2	2	Not Offered	Staff	JRN402-19e00		◇	○	○	○	○	○	○	○

◇ = This course cannot be registered by students that have already registered in course with the same content in the Japanese Track.

All SPSPF Course List — Department of Education

- Instructor: Instructor's name with * = adjunct instructor
 - Attendees: "*" in Attendees, the course is only open to SPSPF students, in case of "*" with "Department's Name, SPSPF only" in Remarks, the course is only open to Department's SPSPF students.
 Courses with blank are open to SPSPF students and other Faculty/Department students.
 - Remarks: [] = Lottery Courses, Number in brackets is the capacity.

Registration CD	Course CD	Course title	Cr.	Semester offered	Instructor	Numbering	Attendees	Remarks	Departments including Education Courses into graduation requirements					
									Journalist Education	Sociology	Economics	Management	Global Studies	
HEDS1060	147007	INTRODUCTION TO EDUCATIONAL STUDIES	2	Not Offered	MANZON, Maria	EDU100-81 e00		Education-SPSPF (students who entered from 2022) only, Team-taught course						
HEDS1010	147000	INTRODUCTION TO COMPARATIVE EDUCATION	2	AUT	MANZON, Maria	EDU235-81 e00								
HEDS1040	147004	CURRICULUM AND INSTRUCTION	2	SPR	SAWADA, Minoru	EDU206-81 e00								
HEDS1030	147003	EDUCATION AND INTERNATIONAL DEVELOPMENT	2	AUT	KOMATSU, Taro	EDU203-81 e00								
HEDS1020	147002	INTERNATIONAL EDUCATION	2	SPR	SUGIMURA, Miki	EDU202-81 e00								
HEDS5010	147021	SPECIAL TOPICS IN EDUCATION 1: PHILOSOPHY OF EDUCATION	2	AUT	UENO, Masamichi	EDU204-81 e00		[20], Prioritized for Education-SPSPF, then other Education students/Every other year						
HEDS5020	147022	SPECIAL TOPICS IN EDUCATION 2: SOCIOLOGY OF EDUCATION	2	Not Offered	AIZAWA, Shinichi	EDU205-81 e00		Every other year						
HEDS5030	147023	SPECIAL TOPICS IN EDUCATION 3: CURRENT ISSUES IN EDUCATION IN ASIA	2	AUT	YAMATO, Yoko*	EDU207-81 e00								
HEDS1050	147001	COMPARATIVE EDUCATION IN ASIA	2	SPR	MANZON, Maria	EDU238-81 e00								
HEDS5040	147024	SPECIAL TOPICS IN EDUCATION 4: EDUCATION FOR CRITICAL ACTION IN THE ANTHROPOCENE	2	AUT	LANGAGER, Mark*	EDU208-81 e00								
HEDS5050	147025	SPECIAL TOPICS IN EDUCATION 5: TBA	2	Not Offered	Staff	EDU209-81 e00								
HEDS4030	147010	BACHELOR'S THESIS / BACHELOR'S GRADUATION PROJECT	5	Not Offered	MANZON Maria	EDU401-81 e00*		Education-SPSPF only						
HEDS4010	147005	RESEARCH IN EDUCATION 1	2	Not Offered	MANZON Maria	EDU403-81 e00*		Education-SPSPF only						
HEDS4020	147006	RESEARCH IN EDUCATION 2	2	Not Offered	MANZON Maria	EDU404-81 e00*		Education-SPSPF only						
HEDS110	147011	UNDERGRADUATE SEMINAR IN EDUCATION 1	2	AUT	MANZON Maria	EDU301-81 e00*		Education-SPSPF only						
HEDS120	147012	UNDERGRADUATE SEMINAR IN EDUCATION 2	2	Not Offered	MANZON Maria	EDU302-81 e00*		Education-SPSPF only						
HEDS130	147013	UNDERGRADUATE SEMINAR IN EDUCATION 3	2	AUT	LANGAGER, Mark*	EDU303-81 e00*		Education-SPSPF only						
HEDS140	147014	UNDERGRADUATE SEMINAR IN EDUCATION 4	2	Not Offered	Staff	EDU304-81 e00*		Education-SPSPF only						

All SPSF Course List — Department of Sociology

- Instructor: Instructor's name with * = adjunct instructor
- Attendees: "*" in Attendees, the course is only open to SPSF students, in case of "*" with "Department's Name_SPSF only" in Remarks, the course is only open to Department's SPSF students.
- Courses with blank are open to SPSF students and other Faculty/Department students.
- Remarks: [] = Lottery Courses. Number in brackets is the capacity.

Registration CD	Course CID	Course title	Cr.	Semester offered	Instructor	Numbering	Attendees	Remarks	Departments including Journalism Education	Sociology	Economic Management	Global Studies
HSCS1010	289200	PRINCIPLES OF SOCIOLOGY	2	AUT	HOMMERICH, Carola	SOC101-83e00		[20], Prioritized for Sociology-SPSF	○	○	○	○
HSCS1030	289202	QUANTITATIVE METHODS IN SOCIOLOGY	2	SPR	HOMMERICH, Carola	SOC103-83e00		[30], Prioritized for Sociology-SPSF	○	○	○	○
HSCS0300	289221	CONTEMPORARY SOCIAL PROBLEMS	2	SPR	KOTTMANN, Nora*	SOC205-83e00		[70], Prioritized for Sociology-SPSF	○	○	○	○
HSCS2030	289203	QUALITATIVE METHODS IN SOCIOLOGY	2	AUT	SPODEN, Celia*	SOC203-83e00		[30], Prioritized for Sociology-SPSF	○	○	○	○
HSCS0400	288807	SOCIAL CHANGE IN POSTWAR JAPAN	2	Not Offered	SARUYA, Hiroe	SOC216-83e00		Every other year; [50], Prioritized for Sociology-SPSF	○	○	○	○
HSCS2010	289204	SOCIOLOGICAL THEORY 1	2	AUT	HOMMERICH, Carola	SOC201-83e00		[30], Prioritized for Sociology-SPSF	○	○	○	○
HSCS2020	289205	SOCIOLOGICAL THEORY 2	2	SPR	HOMMERICH, Carola	SOC202-83e00		[30], Prioritized for Sociology-SPSF	○	○	○	○
HSCS0600	289222	SOCIOLOGY OF FAMILIES	2	Not Offered	TABUCHI, Rokuro	SOC206-83e00		Every other year; [70], Prioritized for Sociology-SPSF	○	○	○	○
HSCS0500	284930	SOCIOLOGY OF GLOBALIZATION	2	SPR	HOSOKI, Iitonen Ralph	SOC213-83e00		[70], Prioritized for Sociology-SPSF	○	○	○	○
HSCS0100	289220	SOCIOLOGY OF HAPPINESS	2	AUT	HOMMERICH, Carola	SOC204-83e00		[70], Prioritized for Sociology-SPSF	○	○	○	○
HSCS0200	288893	WORK AND EMPLOYMENT IN JAPAN	2	AUT	IMAI, Jun	SOC222-83e00		[70], Prioritized for Sociology-SPSF	○	○	○	○
HSCS5130	289226	ENVIRONMENTAL SOCIOLOGY	2	Not Offered	Staff	SOC307-83e00		Every other year; [70], Prioritized for Sociology-SPSF	○	○	○	○
HSCS5110	289224	SPECIAL TOPICS IN SOCIOLOGY 1	2	1Q	GANSEFORTH, Sonja*	SOC305-83e00		[70], Prioritized for Sociology-SPSF	○	○	○	○
HSCS5120	289225	SPECIAL TOPICS IN SOCIOLOGY 2	2	AUT	TAKENOSHITA, Hirohisa*	SOC306-83e00		[70], Prioritized for Sociology-SPSF	○	○	○	○
HSCS1020	289201	FIRST YEAR SEMINAR IN SOCIOLOGY	2	SPR	HOMMERICH, Carola	SOC102-83e00		[15], Prioritized for Sociology-SPSF		○		
HSCS3010	289211	ADVANCED SEMINAR IN SOCIOLOGY	2	AUT	HOMMERICH, Carola	SOC307-83e00	*	Sociology-SPSF only		○		
HSCS3020	289211	ADVANCED SEMINAR IN SOCIOLOGY	2	Not Offered	HOMMERICH, Carola	SOC307-83e00	*	Sociology-SPSF only		○		
HSCS5200	289210	BACHELOR'S THESIS	6	Not Offered	Supervisor	SOC401-83e00	*	Sociology-SPSF only		○		

All SPSF Course List — Department of Economics

- Instructor: Instructor's name with * = adjunct instructor
 - Attendees: "*" in Attendees, the course is only open to SPSF students, in case of "*" with "Department's Name, SPSF only" in Remarks, the course is only open to Department's SPSF students.
 Courses with blank are open to SPSF students and other Faculty/Department students.
 - Remarks: [] = Lottery Courses; Number in brackets is the capacity.

Registration CD	Course CD	Course title	Cr.	Semester offered	Instructor	Numbering	Attendees	Remarks	Departments including Journalism/ Education/ Sociology/ Economics/ Management/ Global Studies
EECS1002	498008	INTRODUCTION TO MACROECONOMICS	2	Not Offered	SCHLEGL, Matthias	ECN113-41-e00	[100]		
EECS1001	498007	INTRODUCTION TO MICROECONOMICS	2	AUT	NAKAMURA, Sayaka	ECN112-41-e00	[100]		
EECS1003	498017	INTRODUCTION TO STATISTICS	2	SPR	NAKAMURA, Sayaka	ECN105-41-e00	[60]		
EECS1004	498009	INTRODUCTION TO DATA ANALYSIS	2	AUT	SCHLEGL, Matthias	ECN262-41-e00	[66]		
EECS5020	498015	ASIAN ECONOMY	2	AUT	KEOLA SOUKNILANH	ECN268-41-e00			
EECS5008	402110	CONTEMPORARY ISSUES IN INTERNATIONAL DEVELOPMENT	2	SPR	OGURA, Tatsuya	ECN210-41-e00			
EECS5025	402080	ENVIRONMENTAL AND NATURAL RESOURCE ECONOMICS	2	SPR	HORIE, Tetsuya	ECN207-41-e00			
EECS5026	402100	GAME THEORY	2	AUT	KAMAGA, Kohei	ECN209-41-e00			
EECS5007	467969	GLOBAL DEVELOPMENT GOALS	2	AUT	PUTHENKALAM, John Joseph	ECN252-41-e00			
EECS5005	402090	GLOBAL ECONOMIC HISTORY	2	Not Offered	Staff	ECN208-41-e00			
EECS5001	402060	INTERNATIONAL ECONOMICS AND BUSINESS	2	AUT	YOMOGIDA, Morihiro	ECN205-41-e00	[200]		
EECS5024	498010	INTERNATIONAL FINANCE	2	SPR	SCHLEGL, Matthias	ECN263-41-e00	[100]		
EECS5004	402120	JAPANESE ECONOMY 1	2	AUT	MINAMIHASHI, Naoki	ECN211-41-e00			
EECS5011	498014	POVERTY IN THE GLOBAL ECONOMY	2	2Q	TAKAMATSU, Shinya	ECN270-41-e00			
EECS5002	498024	PUBLIC ECONOMICS 1	2	SPR	KONDO, Hiroki	ECN273-41-e00			
EECS5018	498021	MATHEMATICS FOR ECONOMICS	2	AUT	KAWANISHI, Satoshi	ECN106-41-e00	[60]		
EECS5019	498016	AFRICAN ECONOMY	2	Not Offered	Staff	ECN269-41-e00			
EECS5900	499000	BACHELOR'S THESIS	4	Not Offered	Staff	ECN401-41-e00		Economics-SPSF Only.	
EECS5030	498028	QUANTITATIVE ANALYSIS OF SOCIAL ISSUES	2	SPR	NAKAMURA, Sayaka	ECN276-41-e00			
EECS5031	498029	ECONOMICS OF SOCIAL POLICY	2	AUT	NAKAMURA, Sayaka	ECN277-41-e00			
EECS5012	498022	SEMINAR-ECONOMICS AND GLOBAL HEALTH 1	2	Not Offered	Staff	ECN272-41-e00			
EECS5028	498026	ACTIVE LEARNING SEMINAR1	2	SPR	NAKAMURA, Sayaka	ECN275-41-e00	[20]		
EECS5027	498025	INTERMEDIATE MACROECONOMICS	2	AUT	SCHLEGL, Matthias	ECN274-41-e00			
EECS5022	498023	SEMINAR-ECONOMICS AND GLOBAL HEALTH 2	2	Not Offered	Staff	ECN306-41-e00			
EECS5029	498027	ACTIVE LEARNING SEMINAR2	2	AUT	NAKAMURA, Sayaka	ECN307-41-e00	[20]		
EECS5801	498030	SPSF SEMINAR: MICROECONOMICS 1	2	Not Offered	Staff	ECN308-41-e00			
EECS5802	498031	SPSF SEMINAR: MICROECONOMICS 2	2	Not Offered	Staff	ECN309-41-e00			
EECS5803	498032	SPSF SEMINAR: MICROECONOMICS 3	2	Not Offered	Staff	ECN402-41-e00			
EECS5804	498033	SPSF SEMINAR: MICROECONOMICS 4	2	Not Offered	Staff	ECN403-41-e00			
EECS5805	498034	SPSF SEMINAR: MACROECONOMICS 1	2	SPR	SCHLEGL, Matthias	ECN310-41-e00			
EECS5806	498035	SPSF SEMINAR: MACROECONOMICS 2	2	AUT	SCHLEGL, Matthias	ECN311-41-e00			
EECS5807	498036	SPSF SEMINAR: MACROECONOMICS 3	2	SPR	SCHLEGL, Matthias	ECN404-41-e00			
EECS5808	498037	SPSF SEMINAR: MACROECONOMICS 4	2	AUT	SCHLEGL, Matthias	ECN405-41-e00			

All SPSF Course List — Department of Management

- Instructor: Instructor's name with * = adjunct instructor
 - Attendees: "*" in Attendees, the course is only open to SPSF students, in case of "*" with "Department's Name SPSF only" in Remarks, the course is only open to Department's SPSF students.
 Courses with blank are open to SPSF students and other Faculty/Department students.
 - Remarks: [] = Lottery Courses. Number in brackets is the capacity.

Registration CD	Course CD	Course title	Cr.	Semester offered	Instructor	Numbering	Attendees	Remarks	Journalism	Education	Sociology	Economics	Management	Global Studies
EMGS1001	468056	INTRODUCTION TO MANAGEMENT 1	2	AUT	TAKINISHI, Atsuko	MMI103-42e00	*	Management-SPSF only						
EMGS1002	468057	INTRODUCTION TO MANAGEMENT 2	2	Not Offered	Staff	MMI104-42e00	*	Management-SPSF only						
EMGS5001	468058	PRINCIPLES OF ACCOUNTING	2	AUT	TAKINISHI, Atsuko	ACC105-42e00		[100]						
EMGS5032	468033	PRINCIPLES OF MANAGEMENT	2	AUT	KAPTURKIEWICZ, Agata	MAN101-42e00		[100]						
EMGS5047	468039	PRINCIPLES OF MARKETING	2	AUT	JOHNS, Adam	MRK101-42e00								
EMGS5037	468052	STRATEGIC MANAGEMENT	2	SPR	KAPTURKIEWICZ, Agata	MAN227-42e00		[100]						
EMGS5038	468068	CHALLENGING FRONTLINE ISSUES IN GLOBAL BUSINESS	4	SPR	AMIKURA, Hisanaga	MAN345-42e00		Summer intensive & on-site practice course						
EMGS5044	468036	CONSUMER BEHAVIOR 1	2	SPR	SUGITANI, Yoko	MRK214-42e00		[200]						
EMGS5045	468037	CONSUMER BEHAVIOR 2	2	AUT	SUGITANI, Yoko	MRK215-42e00		[200]						
EMGS5004	468059	FINANCIAL ACCOUNTING 1	2	SPR	TAKINISHI, Atsuko	ACC211-42e00		[100]						
EMGS5005	468060	FINANCIAL ACCOUNTING 2	2	AUT	TAKINISHI, Atsuko	ACC212-42e00		[100]						
EMGS5041	468050	FUNDAMENTALS OF ACCOUNTING 1	2	Not Offered	WAKABAYASHI, Toshiaki	ACC215-42e00		[100]						
EMGS5042	468051	FUNDAMENTALS OF ACCOUNTING 2	2	AUT	WAKABAYASHI, Toshiaki	ACC216-42e00		[100]						
EMGS5030	468048	GLOBAL MARKETING 1	2	Not Offered	JOHNS, Adam	MRK217-42e00		[100], Restricted to students year 2-4						
EMGS5051	468049	GLOBAL MARKETING 2	2	1Q	JOHNS, Adam	MRK218-42e00		[100], Restricted to students year 2-4						
EMGS5039	468034	MANAGEMENT ACCOUNTING 1	2	Not Offered	Staff	ACC213-42e00		[180]						
EMGS5040	468035	MANAGEMENT ACCOUNTING 2	2	Not Offered	Staff	ACC214-42e00		[180]						
EMGS5048	468040	MARKETING STRATEGY 1	2	SPR	TOGAWA, Taku	MRK212-42e00		[200]						
EMGS5049	468041	MARKETING STRATEGY 2	2	AUT	TOGAWA, Taku	MRK213-42e00		[200]						
EMGS5035	468046	ORGANIZATIONAL BEHAVIOR	2	Not Offered	Staff	MAN235-42e00		[100]						
EMGS5036	468047	ORGANIZATIONAL THEORY AND ANALYSIS	2	AUT	KAPTURKIEWICZ, Agata	MAN236-42e00		[80]						
EMGS5043	468010	GLOBAL BRANDING	2	AUT	JOHNS, Adam	MRK307-42e00		[40], Restricted to students year 2-4						
EMGS5027	468062	INTERNATIONAL ACCOUNTING	2	SPR	TAKINISHI, Atsuko	ACC313-42e00		[100]						
EMGS5033	468044	SPECIAL TOPICS IN MANAGEMENT 1	2	AUT	SCUDDER, Dylan*	MAN331-42e00		[86]						
EMGS5034	468045	SPECIAL TOPICS IN MANAGEMENT 2	2	SPR	KAPTURKIEWICZ, Agata	MAN332-42e00		[30]						
EMGS5046	468038	SPECIAL TOPICS IN MARKETING	2	2Q	JOHNS, Adam	MRK310-42e00		[35]						
EMGS5028	468063	RESEARCH SEMINAR IN MANAGEMENT 1	2	Not Offered	Staff	MMI309-42e00								
EMGS5029	468064	RESEARCH SEMINAR IN MANAGEMENT 2	2	Not Offered	Staff	MMI310-42e00								
EMGS5030	468065	RESEARCH SEMINAR IN MANAGEMENT 3	2	Not Offered	Staff	MMI403-42e00								
EMGS5031	468066	RESEARCH SEMINAR IN MANAGEMENT 4	2	Not Offered	Staff	MMI404-42e00								
EMGS5900	469000	BACHELOR'S THESIS	4	Not Offered	Staff	MMI405-42e00		Management-SPSF only						
EMGS5052	468069	ENTREPRENEURSHIP 1	2	SPR	KAPTURKIEWICZ, Agata	MAN237-42e00		[100]						
EMGS5053	468070	ENTREPRENEURSHIP 2	2	AUT	KAPTURKIEWICZ, Agata	MAN238-42e00		[100]						
EMGS5054	468071	INNOVATION MANAGEMENT	2	Not Offered	KAPTURKIEWICZ, Agata	MAN239-42e00		[100]						

All SPSPF Course List — Department of Global Studies

- Instructor: Instructor's name with * = adjunct instructor
- Attendees: ** in Attendees, the course is only open to SPSPF students, in case of * * with "Department's Name, SPSPF only" in Remarks, the course is only open to *Department's* SPSPF students.
- Courses with blank are open to SPSPF students and other Faculty/Department students.
- Remarks: [] = Lottery Courses. Number in brackets is the capacity.

Registration CD	Course CD	Course title	Cr.	Semester offered	Instructor	Numbering	Attendees	Remarks	Journalism	Education	Sociology	Economics	Management	Global Studies
BGSS1010	BGSS1010	INTRODUCTION TO GLOBAL STUDIES	2	AUT	MARUI, Masako	GST110-21e00	*	SPSPF only, Team-taught course						
BGSS1020	BGSS1020	INTRODUCTION TO INTERNATIONAL RELATIONS	2	AUT	KISHIKAWA, Takashi	IRS110-21e00	*	SPSPF only, Team-taught course						
BGSS1030	BGSS1030	INTRODUCTION TO AREA STUDIES	2	AUT	FUKUYAKE, Shintaro	ARS110-21e00	*	SPSPF only, Team-taught course						
BGSS1040	BGSS1040	ACADEMIC SKILLS FOR GLOBAL STUDIES	2	AUT	KOBAYASHI, Ayako	GST23-21e00	*	FGS-SPSPF only						
BGSS3000	BGSS0201	GLOBALIZATION AND ECONOMICS 2	2	AUT	TAKASHIMA, Ryo	GST202-21e00								
BGSS3001	BGSS9700	INTERNATIONAL POLITICS: THEORY AND PRACTICE	2	AUT	KOBAYASHI, Ayako	IRS216-21e00								
BGSS3002	BGSS9800	INTERNATIONAL ORGANIZATION: THEORY AND PRACTICE	2	SPR	KOBAYASHI, Ayako	IRS217-21e00								
BGSS3003	BGSS2000	BASICS OF INTERNATIONAL COOPERATION B	2	SPR	OHASHI, Chihoro*	ICP223-21e00		Intensive course						
BGSS3004	BGSS2001	BASICS OF SOUTHEAST ASIAN STUDIES B	2	SPR	KUSHIMOTO, Hiroko	ASA233-21e00								
BGSS3005	BGSS5800	THEORY OF INTERNATIONAL POLITICS	2	AUT	SUZUKI, Kazutoshi	IRS323-21e00								
BGSS3006	BGSS2002	EDUCATION FOR MINORITIES IN JAPAN	2	AUT	TOKUNAGA, Tomoko*	ICP321-21e00								
BGSS3007	BGSS7900	SOCIETY AND POLITICS IN SOUTH ASIA	2	AUT	AUGUSTINE, Sali	ASA318-21e00								
BGSS3008	BGSS5800	CONTEMPORARY SOCIETIES OF THE MIDDLE EAST	2	AUT	TODA, Mikako	AME318-21e00								
BGSS3010	BGSS58100	LIFE AND CULTURE IN AFRICA	2	AUT	TSUJIGAMI, Nami	AAF316-21e00								
BGSS3011	BGSS2004	AFRICA'S DEVELOPMENT AID	2	AUT	TSUKENDWA, Manadi Ghislain	AAF320-21e00								
BGSS3012	BGSS2005	ANTHROPOLOGY OF SUFFERINGS AND HOPES IN AFRICA	2	AUT	TSHKENDWA, Manadi Ghislain	AAF321-21e00								
BGSS3013	BGSS2006	BASICS OF THEORIES OF CIVIL SOCIETY B	2	AUT	WEISS, Tobias	ICP224-21e00								
BGSS3014	BGSS2007	CONFLICT RESOLUTION B	2	AUT	KOBAYASHI, Ayako	IRS323-21e00								
BGSS3015	BGSS9000	PEACE RESEARCH	2	SPR	KOBAYASHI, Ayako	IRS327-21e00								
BGSS3016	BGSS9500	ASIAN POLITICS	2	SPR	KOBAYASHI, Ayako	ASA324-21e00								
BGSS3017	BGSS2008	MODERN HISTORY OF THE MIDDLE EAST B	2	AUT	YAMAUCHI, Akihiko	AME323-21e00								
BGSS4001	BGSS7516	ADVANCED STUDIES (INTERNATIONAL HUMAN RIGHTS)	2	SPR	KOBAYASHI, Ayako	IRS406-21e00								
BGSS4002	BGSS2300	ADVANCED STUDIES (DEMOCRACY AND CONFLICT)	2	SPR	NAKAUCHI, Masataka	IRS407-21e00								
BGSS4003	BGSS7505	ADVANCED STUDIES (INTERNATIONAL ORGANIZATION B)	2	SPR	OGISU, Takayo	ICP401-21e00								
BGSS4004	BGSS7508	ADVANCED STUDIES (CULTURES AND SOCIETIES OF ASIA)	2	SPR	YONENO-REYES, Michiyo*	ASA402-21e00								
BGSS4005	BGSS7507	ADVANCED STUDIES (CONTEMPORARY SOCIETIES OF ASIA)	2	SPR	VARGHESE, Matthew*	ASA401-21e00								
BGSS4006	BGSS7517	ADVANCED STUDIES (GLOBAL MIGRATION AND KOREANS IN JAPAN)	2	AUT	KWON, Hyang Suk	ASA404-21e00								
BGSS5000	BGSS5000	INDEPENDENT STUDIES 1	2	AUT	Staff**	IDR262-21e00	*	FGS-SPSPF only						
BGSS5001	BGSS5001	INDEPENDENT STUDIES 2	2	SPR	Staff**	IDR263-21e00	*	FGS-SPSPF only						
BGSS5002	BGSS5002	INDEPENDENT STUDIES 3	2	AUT	Staff**	IDR264-21e00	*	FGS-SPSPF only						
BGSS5003	BGSS5003	INDEPENDENT STUDIES 4	2	Not Offered	Staff**	IDR265-21e00	*	FGS-SPSPF only						
BGSS5004	BGSS5004	INDEPENDENT STUDIES 5	2	Not Offered	Staff**	IDR266-21e00	*	FGS-SPSPF only						
BGSS5005	BGSS5005	INDEPENDENT STUDIES 6	2	Not Offered	Staff**	IDR267-21e00	*	FGS-SPSPF only						
BGSS5010	BGSS5010	INDEPENDENT STUDIES 2a	1	1Q	Staff**	IDR268-21e00	*	FGS-SPSPF only						
BGSS5011	BGSS5011	INDEPENDENT STUDIES 2b	1	2Q	Staff**	IDR269-21e00	*	FGS-SPSPF only						
BGSS5012	BGSS5012	INDEPENDENT STUDIES 4a	1	Not Offered	Staff**	IDR270-21e00	*	FGS-SPSPF only						
BGSS5013	BGSS5013	INDEPENDENT STUDIES 4b	1	Not Offered	Staff**	IDR271-21e00	*	FGS-SPSPF only						
BGSS5014	BGSS5014	INDEPENDENT STUDIES 6a	1	Not Offered	Staff**	IDR272-21e00	*	FGS-SPSPF only						
BGSS5015	BGSS5015	INDEPENDENT STUDIES 6b	1	Not Offered	Staff**	IDR273-21e00	*	FGS-SPSPF only						
BGSS6000	BGSS6000	SEMINAR (INTERNATIONAL RELATIONS) 1	2	AUT	KOBAYASHI, Ayako	IRS472-21e00	*	FGS-SPSPF only						
BGSS6001	BGSS6001	SEMINAR (INTERNATIONAL RELATIONS) 2	2	Not Offered	KOBAYASHI, Ayako	IRS473-21e00	*	FGS-SPSPF only						
BGSS6010	BGSS6010	SEMINAR(AREA STUDIES) 1	2	AUT	AUGUSTINE, Sali	ASA462-21e00	*	FGS-SPSPF only						
BGSS6011	BGSS6011	SEMINAR(AREA STUDIES) 2	2	Not Offered	AUGUSTINE, Sali	ASA463-21e00	*	FGS-SPSPF only						
BGSS9000	BGSS9000	BACHELORS THESIS 1	2	Not Offered	Staff	GRP412-21e00	*	FGS-SPSPF only						
BGSS9010	BGSS9010	BACHELORS THESIS 2	2	Not Offered	Staff	GRP414-21e00	*	FGS-SPSPF only						

** The instructors in charge of "Independent Study 1 to 3" are as follows.
 INDEPENDENT STUDIES 1-3: except Inaba, Maki, Ogisu
 INDEPENDENT STUDIES 2-2a-2b: except Savae, Tanaka, Watanabe, Ogisu

General Information

Campus Map

… P. 192

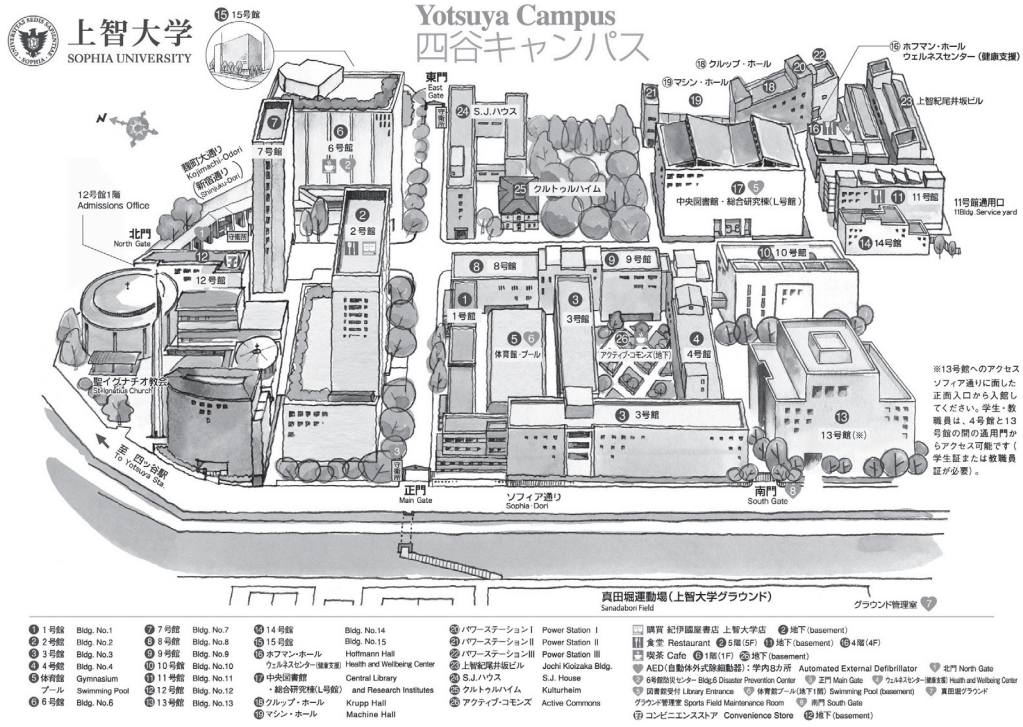

Yotsuya Campus

Bulletin Boards in Building No.2 1F

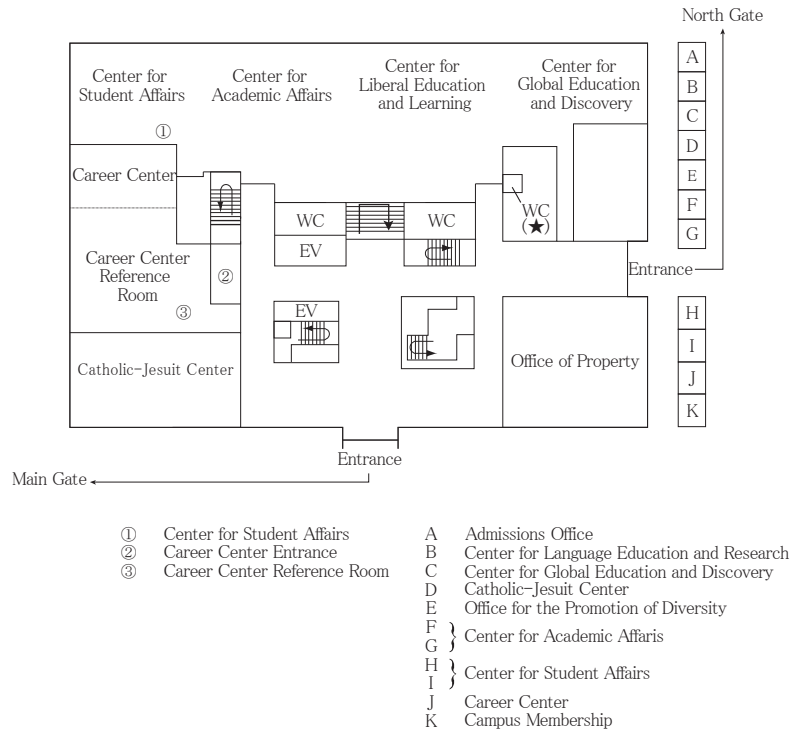

*WC(★): For details, refer to the Accessibility Map on the University website and the Sophians' Guide

Building No.1,3,4,8,9

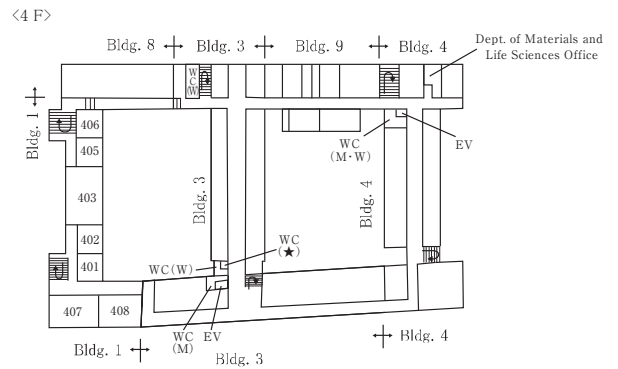
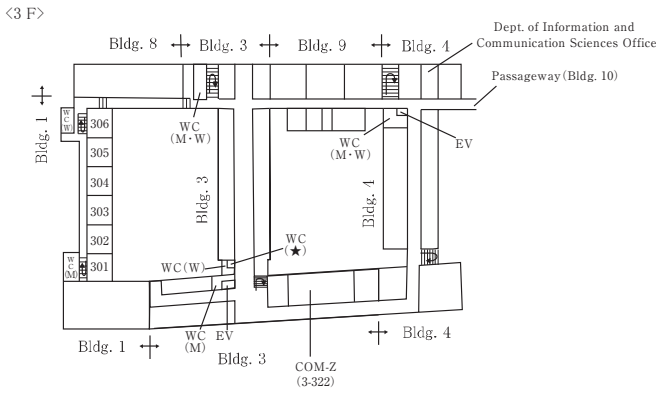
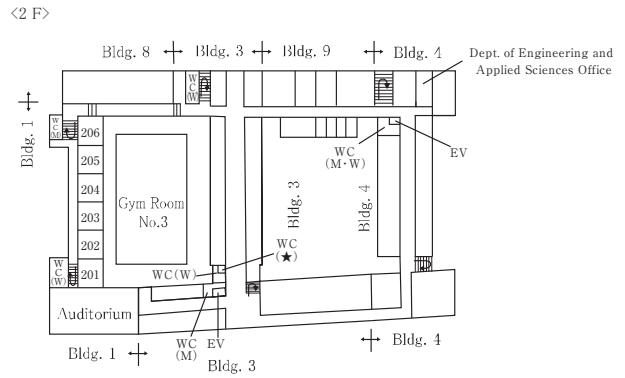
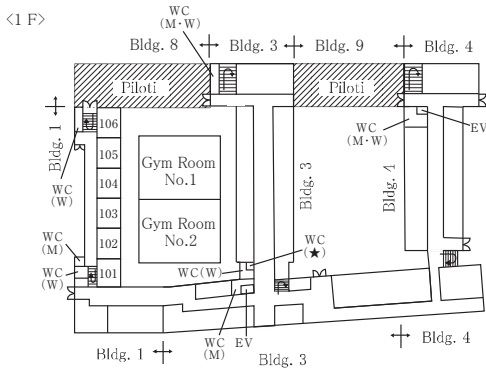

General Information

*WC(★): For details, refer to the Accessibility Map on the University website and the Sophians' Guide

Building No.2

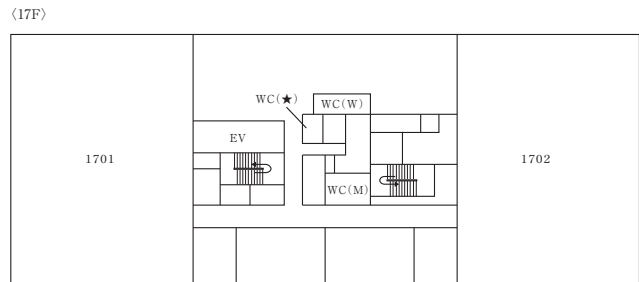
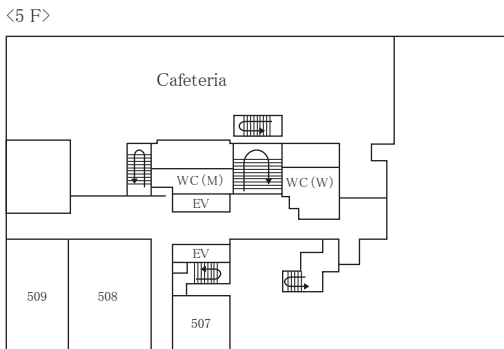
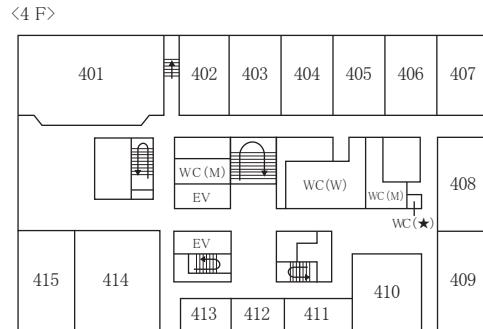
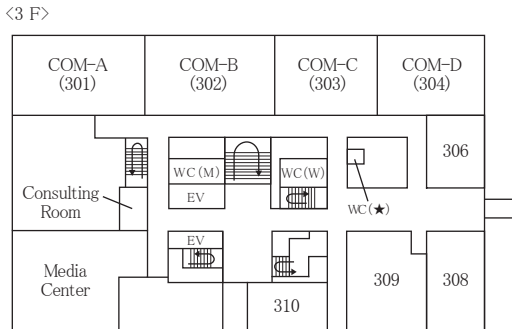
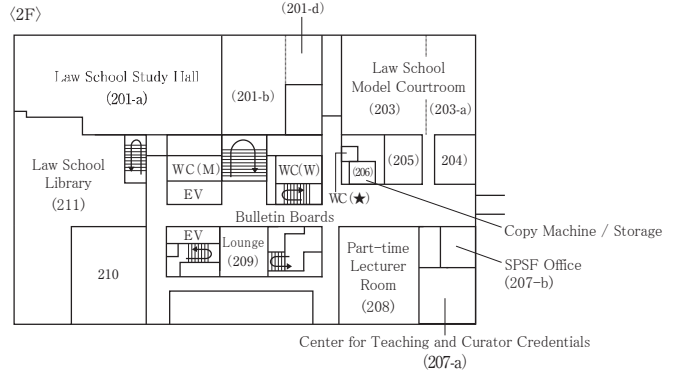
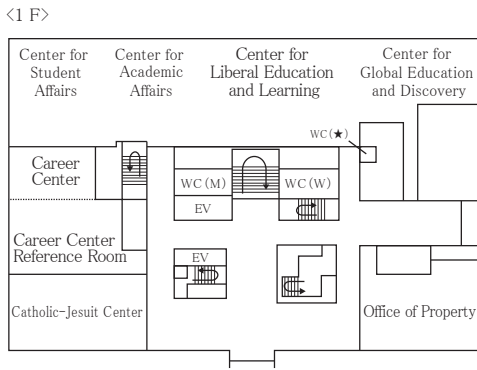
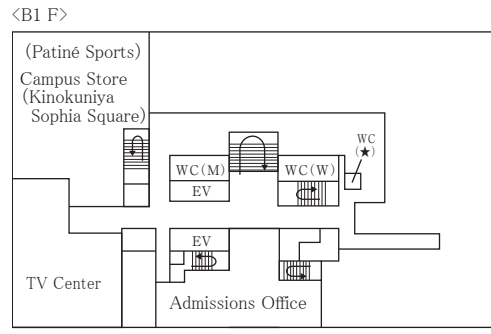
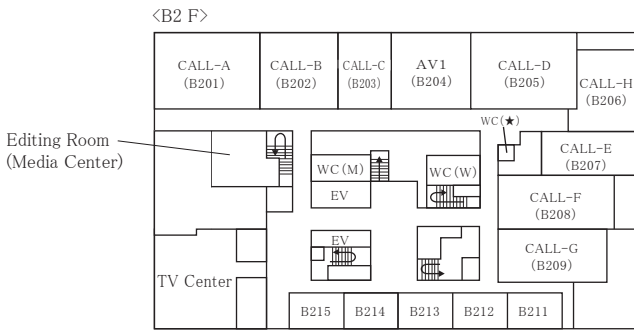

*WC(★): For details, refer to the Accessibility Map on the University website and the Sophians' Guide

Building No.6

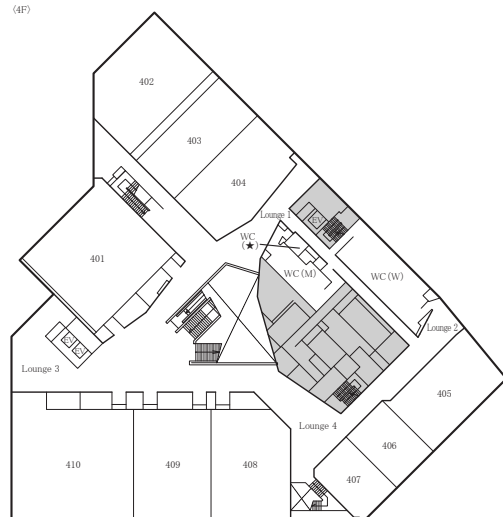
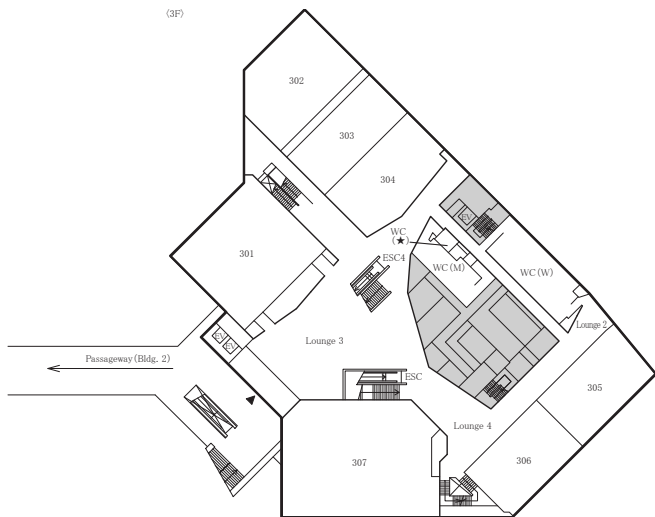
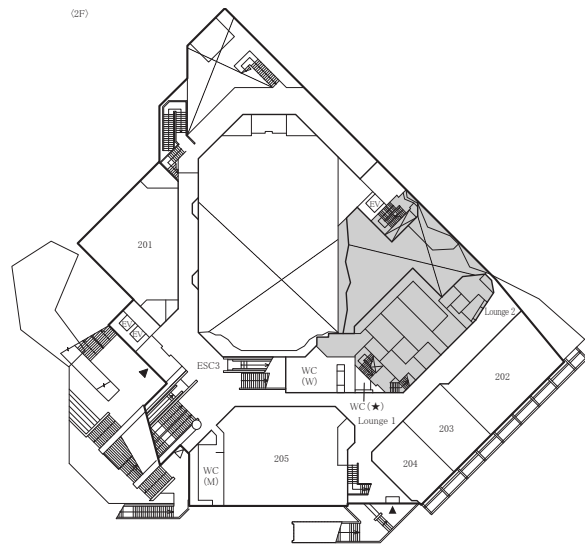
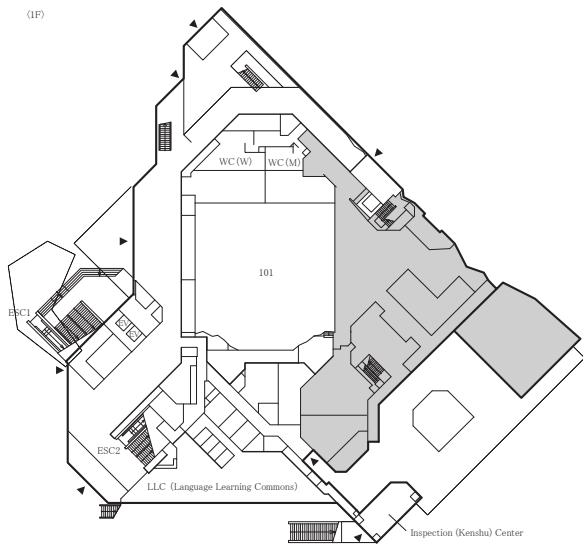

General Information

*WC(★): For details, refer to the Accessibility Map on the University website and the Sophians' Guide

Central Library (Building L)

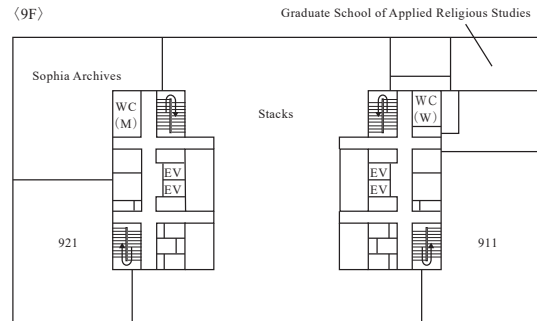
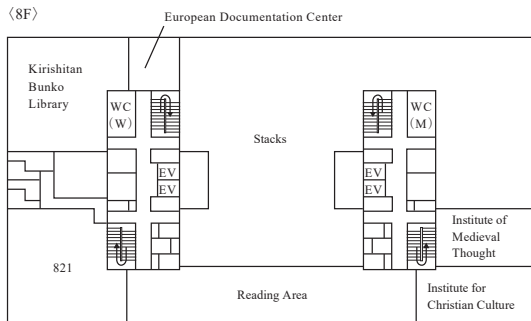
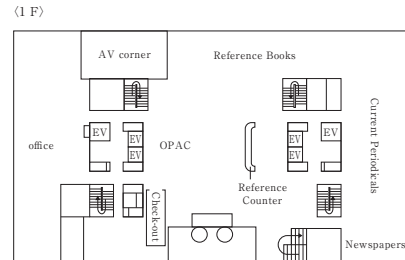
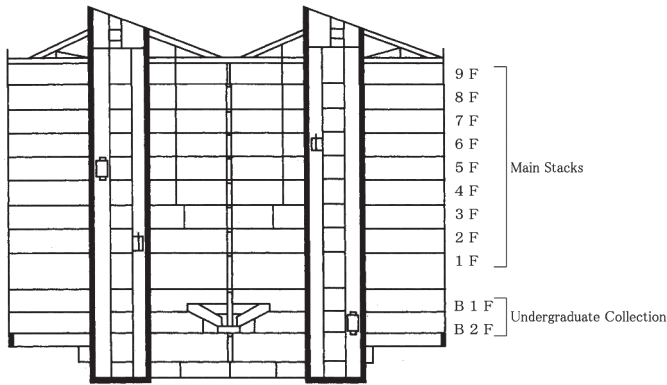

Building No.10

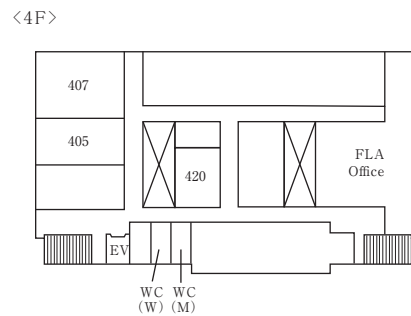
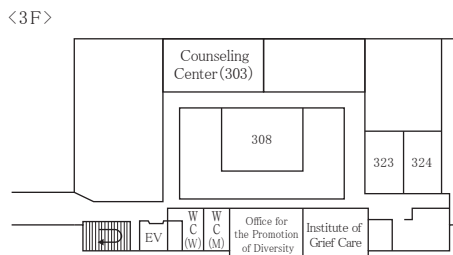
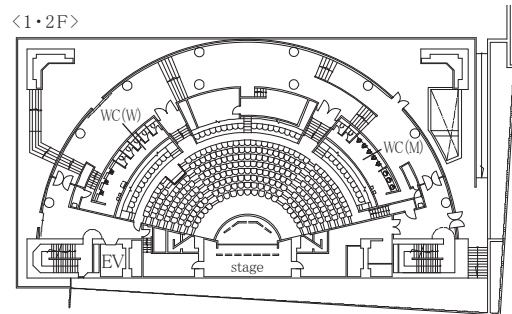
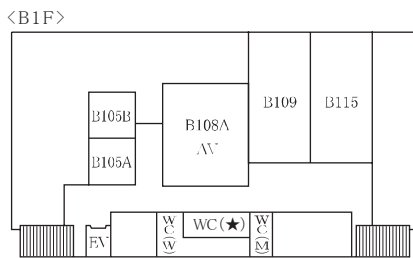

*WC(★): For details, refer to the Accessibility Map on the University website and the Sophians' Guide

Building No.11 & Jochi Kioizaka Building

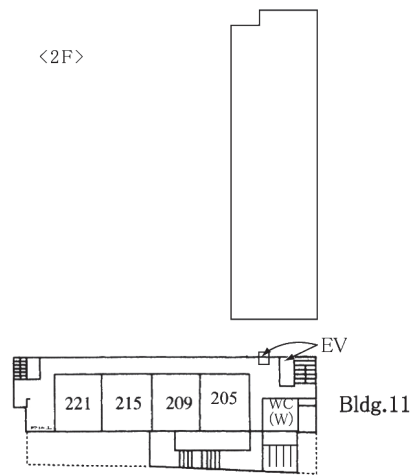
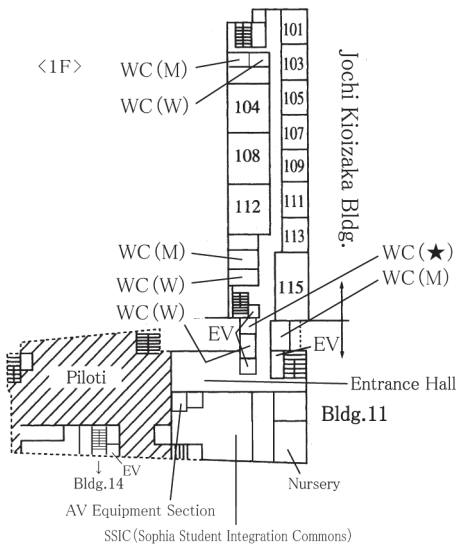
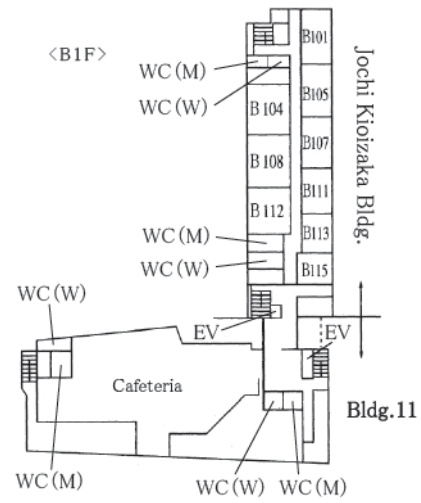
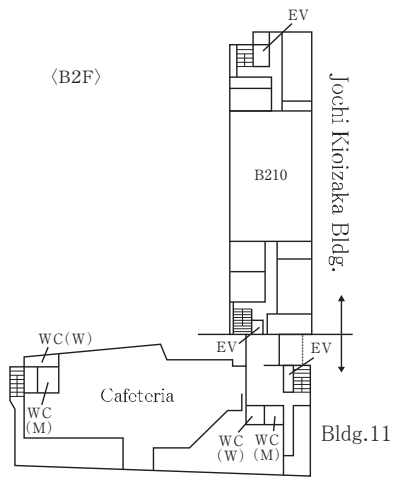

General Information

*WC(★): For details, refer to the Accessibility Map on the University website and the Sophians' Guide

Building No.11

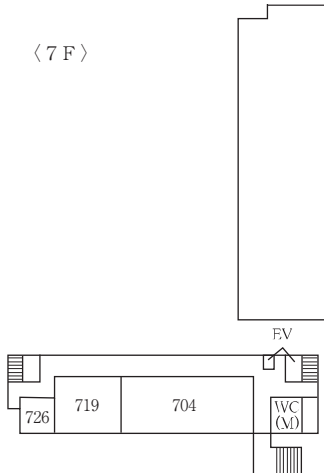
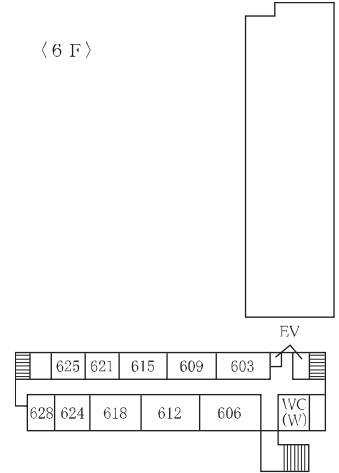
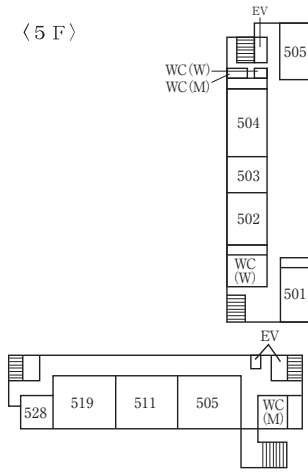
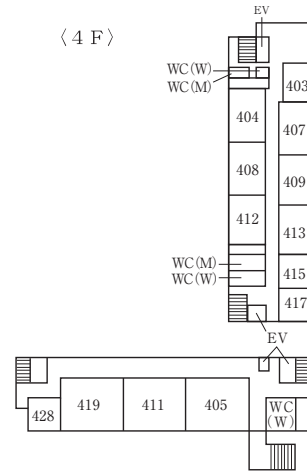
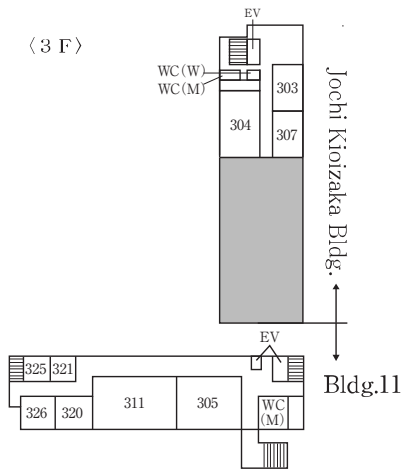

General Information

*WC(★): For details, refer to the Accessibility Map on the University website and the Sophians' Guide

Building No.12

(B1F)

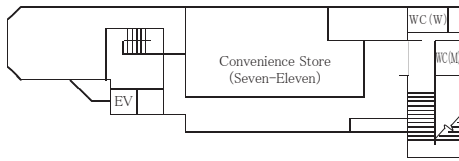

(1F)

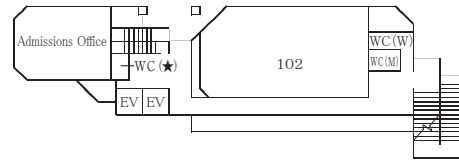

(2F)

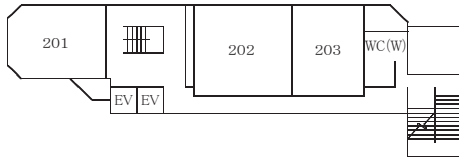

(3F)

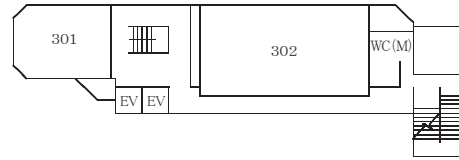

(4F)

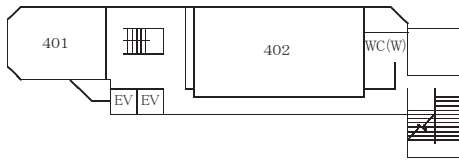

(5F)

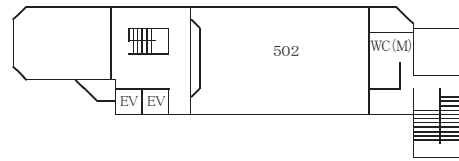

Building No.14

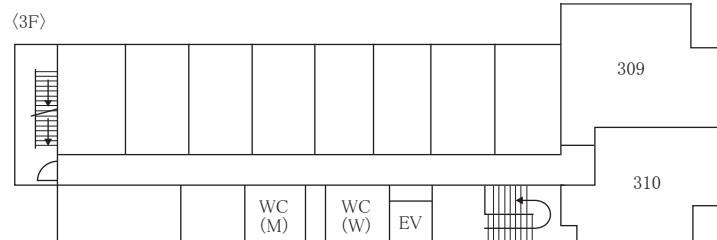
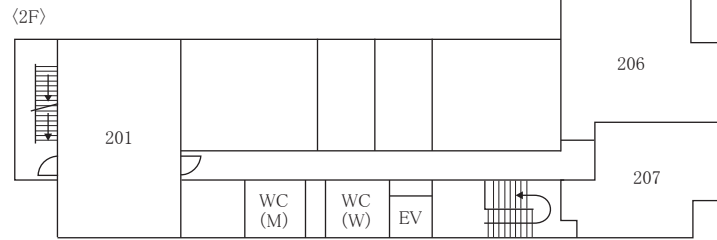
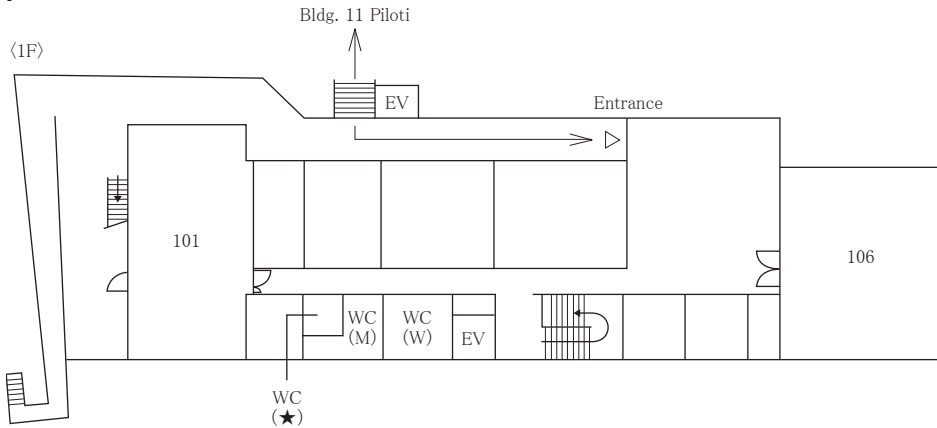

*WC(★): For details, refer to the Accessibility Map on the University website and the Sophians' Guide

Krupp Hall / Machine Hall

1F

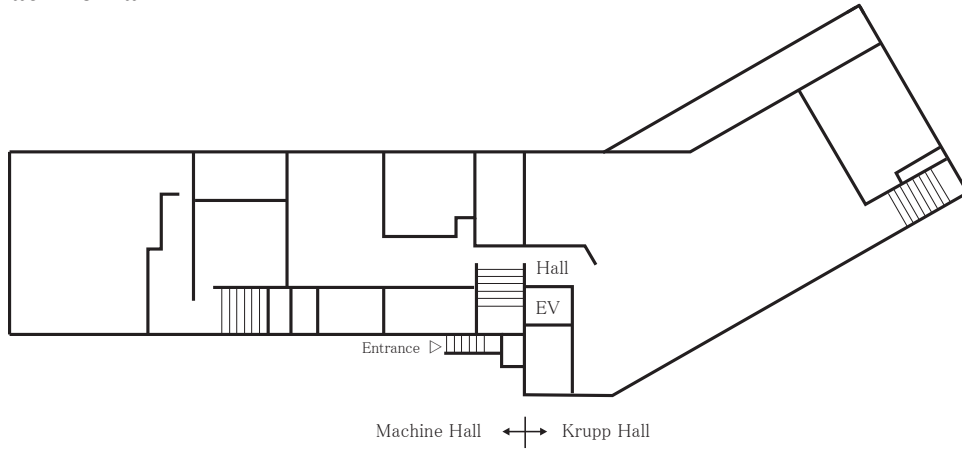

2F

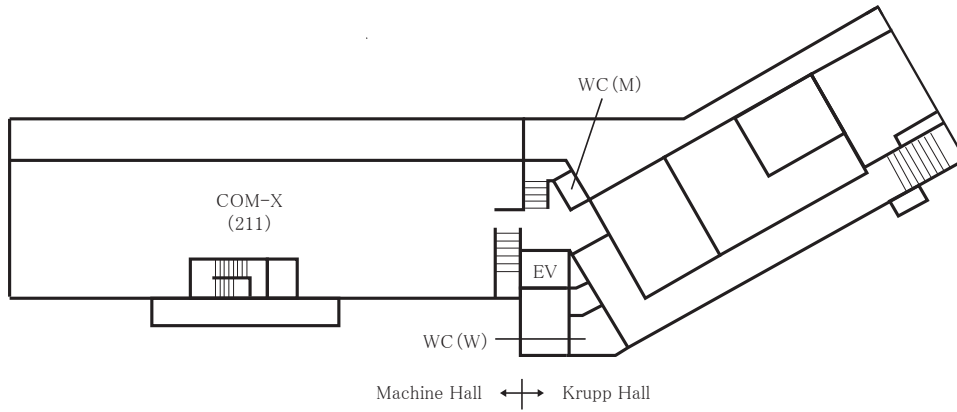

*WC(★): For details, refer to the Accessibility Map on the University website and the Sophians' Guide

Mejiro Campus

Building No.1

(B1F)

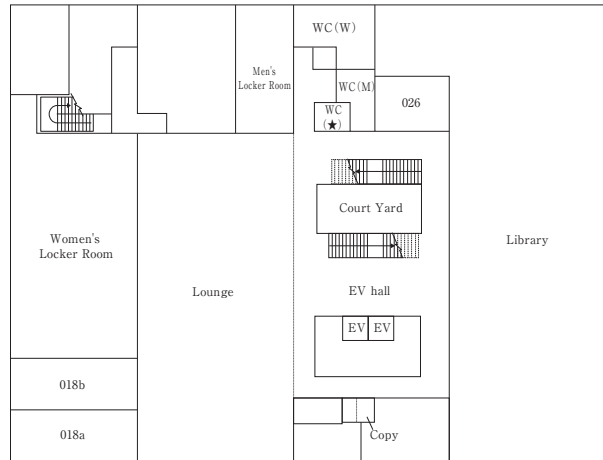

(1F)

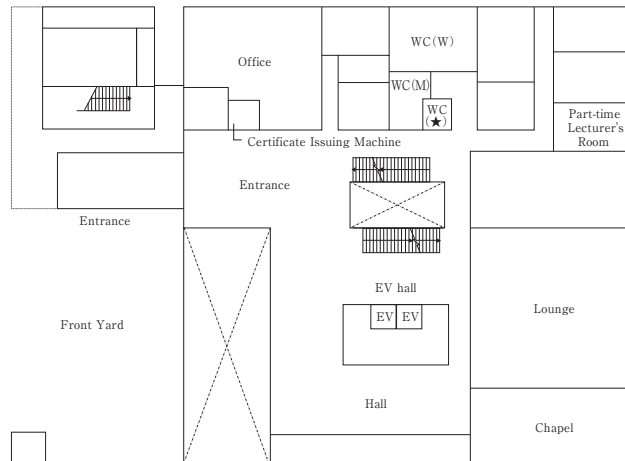

(2F)

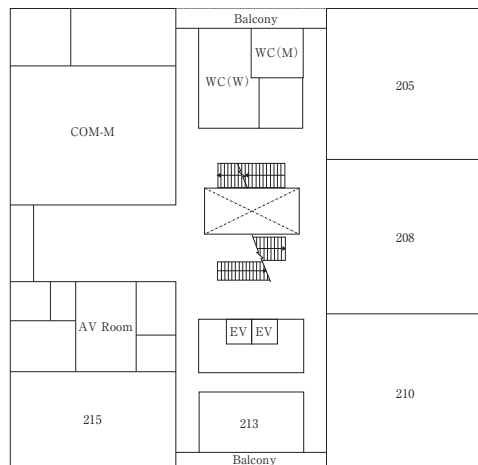

*WC(★): For details, refer to the Accessibility Map on the University website and the Sophians' Guide

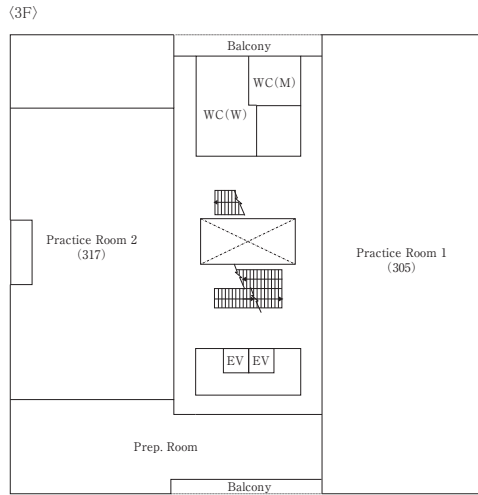

Building No.2

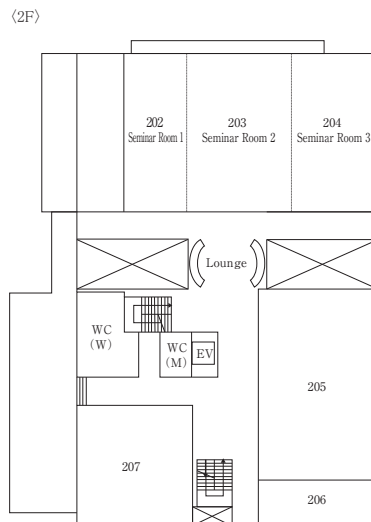
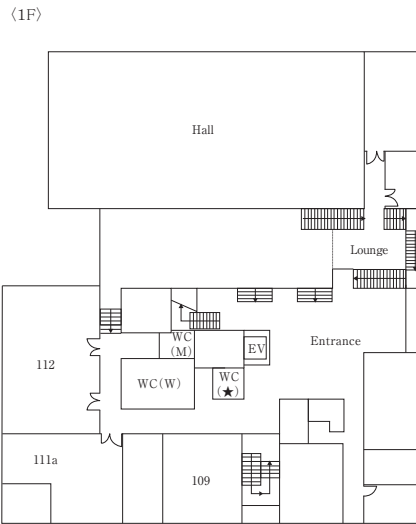

*WC(★): For details, refer to the Accessibility Map on the University website and the Sophians' Guide