

Introduction

The Educational Ideals of Sophia University

… P. 2

A message to Students of Faculty of Science and Technology

… P. 3

INTRODUCTION

The Educational Ideals of Sophia University

Based on Christian principles of education, Sophia University attests to the four-hundred-year-old interest of the Jesuit Order in Japan. Its aim is to prepare men and women coming from different countries to recognize in the different cultural traditions of the world the fundamental unity of the human race and to work for the concrete achievement of that unity. The roots of the university go back to 1549, when St. Francis Xavier, a Jesuit, landed in Kagoshima with the hope of starting a Catholic university which would introduce Western culture to Japan. In 1908, nearly 360 years later, three members of the Society of Jesus—the German Father Joseph Dahlmann, the French Father Henri Boucher, and the English Father James Rockliff—came to Japan with the mission of fulfilling St. Francis Xavier’s aspiration. As a result of their efforts, Sophia University was established in 1913, when the Japanese Ministry of Education gave the Jesuits permission to found a new educational institution under the Japanese name of Jōchi Gakuin. Sixteen students enrolled in the first class. From this modest beginning Sophia University has grown to be one of the foremost of Japan’s private universities with a student body of over 12,000 undergraduate and graduate students and a teaching staff of more than one thousand. In the tradition of the international character of Sophia’s founders, the faculty members represent twenty different nationalities; they are committed to conveying to the next generation through their scholarship and teaching both humankind’s cultural and intellectual heritage and a concern for the problems facing the world today.

A Message to Students of Faculty of Science and Technology

Welcome to new undergraduate programs, Green Science and Green Engineering. The Green Science Program is established as part of the Department of Materials and Life Sciences, and the Green Engineering Program as part of the Department of Engineering and Applied Sciences in the Faculty of Science and Technology, Sophia University. The goal of these programs is to cultivate talented scientists and technologists with what we term “cross-disciplinary knowledge,” which enables them to contribute to the resolution of complicated environmental problems facing society, such as the wholesale destruction of the global environment. As members of a global community, future scientists and technologists will need a clear vision not only of their special fields regarding environmental sciences and technologies but also of the society of which it is a part. They will need to take into account issues of human development and of harmonious coexistence with people and nature. As the Faculty's campus is also home to liberal arts courses, students can readily participate in non-science courses that can help to develop their value systems and improve their understanding of people, societies, and the environment. Class sizes are kept small, so that students can communicate closely with their instructors as they pursue their chosen field of sciences and technologies, beginning with basics and then continuing on to more advanced studies. Why don't you become a specialist of green science and technology able to handle the new age and to participate on the global stage as a Sophia University graduate, Sophian?

Takashi HAYASHITA
Dean of the Faculty of Science and Technology
Sophia University

Common Guidelines

2012 Yotsuya Campus academic calendar	… P. 6
Frequently Asked Questions	… P. 8
Offices to visit for inquiries / office hours	… P. 10
Announcements / Notices	… P. 11
Guidance Programs	… P. 11
How to contact your teachers	… P. 12
Change of address	… P. 12
If public transport service is shut down	… P. 12
Protection of Personal Information	… P. 12

Common Guidelines

● 2012 Yotsuya Campus Academic Calendar

Calendar		Undergraduate Program Academic Calendar																																												
<p>○ : Vacation, National holidays, Saturdays.</p> <p>■ : Offices closed on days other than national holidays</p> <p>□ : Virtual Day</p>																																														
<p>September</p> <table border="1"> <thead> <tr> <th>mon</th><th>tue</th><th>wed</th><th>thu</th><th>fri</th><th>sat</th><th>sun</th></tr> </thead> <tbody> <tr> <td></td><td></td><td></td><td></td><td></td><td>1</td><td>2</td></tr> <tr> <td>3</td><td>4</td><td>5</td><td>6</td><td>7</td><td>8</td><td>9</td></tr> <tr> <td>10</td><td>11</td><td>12</td><td>13</td><td>14</td><td>15</td><td>16</td></tr> <tr> <td>17</td><td>18</td><td>19</td><td>20</td><td>21</td><td>22</td><td>23</td></tr> <tr> <td>24</td><td>25</td><td>26</td><td>27</td><td>28</td><td>29</td><td>30</td></tr> </tbody> </table> <p>※Summer vacation : Aug 1 to Sept 27</p> <p>Autumn Semester classes Sept 28 to Jan 24</p>		mon	tue	wed	thu	fri	sat	sun						1	2	3	4	5	6	7	8	9	10	11	12	13	14	15	16	17	18	19	20	21	22	23	24	25	26	27	28	29	30	<p>21</p> <p>Autumn Semester begins Entrance Ceremony, new students guidance</p> <p>23~24</p> <p>Orientation Camp</p> <p>21~24</p> <p>Autumn Semester Pre-registration period (1st)</p> <p>25</p> <p>Autumn Semester Pre-registration period (2nd)</p> <p>27</p> <p>Deadline for Request for Grade Review of 2012 Spring Semester courses</p> <p>28</p> <p>Autumn Semester classes begin <junior/ senior> Autumn Semester Course Registration Period (until Oct. 4) <students on study abroad (returning)/ on leave of absence (resuming studies.> Course Continuation Registration period (until Oct.8) ("Keizoku Rishu Negai")</p>		
mon	tue	wed	thu	fri	sat	sun																																								
					1	2																																								
3	4	5	6	7	8	9																																								
10	11	12	13	14	15	16																																								
17	18	19	20	21	22	23																																								
24	25	26	27	28	29	30																																								
<p>October</p> <table border="1"> <thead> <tr> <th>mon</th><th>tue</th><th>wed</th><th>thu</th><th>fri</th><th>sat</th><th>sun</th></tr> </thead> <tbody> <tr> <td>1</td><td>2</td><td>3</td><td>4</td><td>5</td><td>6</td><td>7</td></tr> <tr> <td>8</td><td>9</td><td>10</td><td>11</td><td>12</td><td>13</td><td>14</td></tr> <tr> <td>15</td><td>16</td><td>17</td><td>18</td><td>19</td><td>20</td><td>21</td></tr> <tr> <td>22</td><td>23</td><td>24</td><td>25</td><td>26</td><td>27</td><td>28</td></tr> <tr> <td>29</td><td>30</td><td>31</td><td></td><td></td><td></td><td></td></tr> </tbody> </table> <p>※Classes are held on 8th, Health Sports Day</p> <p>Autumn Semester classes : Sept 28~Jan 24</p>		mon	tue	wed	thu	fri	sat	sun	1	2	3	4	5	6	7	8	9	10	11	12	13	14	15	16	17	18	19	20	21	22	23	24	25	26	27	28	29	30	31					<p>Sept 28~Oct 4</p> <p><junior, senior> Autumn Semester Course Registration Period</p> <p>Sept 29~Oct 4</p> <p><freshman, sophomore> Autumn Semester Course Registration Period</p> <p>Sept 28~8</p> <p><students on study abroad (returning)/ on leave of absence (resuming studies.> Course Continuation Registration period (at office desk)</p> <p>5~6</p> <p><all students> Results of Course Registration available</p> <p>5~8</p> <p><senior> Change of Course Category/ Self Evaluation Period</p> <p>7~8</p> <p>Course Adjustment Period</p> <p>8</p> <p>Class held on national holiday (Health Sports Day)</p> <p>31</p> <p>Eve of Sophia Festival (No class day)</p>		
mon	tue	wed	thu	fri	sat	sun																																								
1	2	3	4	5	6	7																																								
8	9	10	11	12	13	14																																								
15	16	17	18	19	20	21																																								
22	23	24	25	26	27	28																																								
29	30	31																																												
<p>November</p> <table border="1"> <thead> <tr> <th>mon</th><th>tue</th><th>wed</th><th>thu</th><th>fri</th><th>sat</th><th>sun</th></tr> </thead> <tbody> <tr> <td></td><td></td><td></td><td>1</td><td>2</td><td>3</td><td>4</td></tr> <tr> <td>5</td><td>6</td><td>7</td><td>8</td><td>9</td><td>10</td><td>11</td></tr> <tr> <td>12</td><td>13</td><td>14</td><td>15</td><td>16</td><td>17</td><td>18</td></tr> <tr> <td>19</td><td>20</td><td>21</td><td>22</td><td>23</td><td>24</td><td>25</td></tr> <tr> <td>26</td><td>27</td><td>28</td><td>29</td><td>30</td><td></td><td></td></tr> </tbody> </table> <p>※Classes are held on 23rd Labor Thanksgiving Day</p>		mon	tue	wed	thu	fri	sat	sun				1	2	3	4	5	6	7	8	9	10	11	12	13	14	15	16	17	18	19	20	21	22	23	24	25	26	27	28	29	30			<p>1~3</p> <p>Sophia Festival</p> <p>1</p> <p>Foundation Day (No class day)</p> <p>2</p> <p>Memorial Service (No class day)</p> <p>23</p> <p>Class held on national holiday (Labor Thanksgiving Day)</p> <p>30</p> <p><students on study abroad (before leaving)/ on leave of absence (Autumn2012 to Spring2013)> Deadline for Request for Course Continuation: Leave of absence Application dead line for Autumn Semester</p>		
mon	tue	wed	thu	fri	sat	sun																																								
			1	2	3	4																																								
5	6	7	8	9	10	11																																								
12	13	14	15	16	17	18																																								
19	20	21	22	23	24	25																																								
26	27	28	29	30																																										

Calendar ○ : Vacation, National holidays, Saturdays. □ : Offices closed on days other than national holidays □ : Virtual Day		Undergraduate Program Academic Calendar																																																									
<table border="1"> <thead> <tr> <th colspan="7">December</th> </tr> <tr> <th>mon</th><th>tue</th><th>wed</th><th>thu</th><th>fri</th><th>sat</th><th>sun</th> </tr> </thead> <tbody> <tr> <td></td><td></td><td></td><td></td><td></td><td>①</td><td>②</td> </tr> <tr> <td>3</td><td>4</td><td>5</td><td>6</td><td>7</td><td>⑧</td><td>⑨</td> </tr> <tr> <td>10</td><td>11</td><td>12</td><td>13</td><td>14</td><td>⑮</td><td>⑯</td> </tr> <tr> <td>17</td><td>18</td><td>19</td><td>20</td><td>21</td><td>⑳</td><td>㉑</td> </tr> <tr> <td>24</td><td>25</td><td>26</td><td>27</td><td>28</td><td>㉘</td><td>㉙</td> </tr> <tr> <td>31</td><td></td><td></td><td></td><td></td><td></td><td></td> </tr> </tbody> </table> ※Winter Recess : Dec 23~Jan 6		December							mon	tue	wed	thu	fri	sat	sun						①	②	3	4	5	6	7	⑧	⑨	10	11	12	13	14	⑮	⑯	17	18	19	20	21	⑳	㉑	24	25	26	27	28	㉘	㉙	31							3	St. Xavier's Day (No classes for Undergraduate/Graduate Programs except for Law School)
December																																																											
mon	tue	wed	thu	fri	sat	sun																																																					
					①	②																																																					
3	4	5	6	7	⑧	⑨																																																					
10	11	12	13	14	⑮	⑯																																																					
17	18	19	20	21	⑳	㉑																																																					
24	25	26	27	28	㉘	㉙																																																					
31																																																											
		10~14	Deadline for submitting graduation theses																																																								
		9~14	Course Withdrawal Period																																																								
		22	Classes end																																																								
		23~	Winter Recess (until January 6)																																																								
<table border="1"> <thead> <tr> <th colspan="7">2013 January</th> </tr> <tr> <th>mon</th><th>tue</th><th>wed</th><th>thu</th><th>fri</th><th>sat</th><th>sun</th> </tr> </thead> <tbody> <tr> <td></td><td>1</td><td>2</td><td>3</td><td>4</td><td>⑤</td><td>⑥</td> </tr> <tr> <td>7</td><td>8</td><td>9</td><td>10</td><td>11</td><td>⑫</td><td>⑬</td> </tr> <tr> <td>⑭</td><td>⑮</td><td>16</td><td>17</td><td>18</td><td>⑰</td><td>⑱</td> </tr> <tr> <td>21</td><td>22</td><td>23</td><td>24</td><td>25</td><td>⑳</td><td>㉑</td> </tr> <tr> <td>28</td><td>29</td><td>30</td><td>31</td><td></td><td></td><td></td> </tr> </tbody> </table> ※Winter Recess : Dec 23~Jan 6		2013 January							mon	tue	wed	thu	fri	sat	sun		1	2	3	4	⑤	⑥	7	8	9	10	11	⑫	⑬	⑭	⑮	16	17	18	⑰	⑱	21	22	23	24	25	⑳	㉑	28	29	30	31				7	Autumn Semester classes resume							
2013 January																																																											
mon	tue	wed	thu	fri	sat	sun																																																					
	1	2	3	4	⑤	⑥																																																					
7	8	9	10	11	⑫	⑬																																																					
⑭	⑮	16	17	18	⑰	⑱																																																					
21	22	23	24	25	⑳	㉑																																																					
28	29	30	31																																																								
		12·19	Autumn Semester Make-up classes																																																								
		11	Autumn Semester Final Exams schedule announced																																																								
		15	Virtual Monday																																																								
		24	Autumn Semester classes end																																																								
		25~Feb 1	Autumn Semester Final Examinations Period (February 1 is an extra day)																																																								
<table border="1"> <thead> <tr> <th colspan="7">February</th> </tr> <tr> <th>mon</th><th>tue</th><th>wed</th><th>thu</th><th>fri</th><th>sat</th><th>sun</th> </tr> </thead> <tbody> <tr> <td></td><td></td><td></td><td></td><td>1</td><td>②</td><td>③</td> </tr> <tr> <td>4</td><td>5</td><td>6</td><td>7</td><td>8</td><td>⑨</td><td>⑩</td> </tr> <tr> <td>⑪</td><td>12</td><td>13</td><td>14</td><td>15</td><td>⑯</td><td>⑰</td> </tr> <tr> <td>18</td><td>19</td><td>20</td><td>21</td><td>22</td><td>㉒</td><td>㉓</td> </tr> <tr> <td>25</td><td>26</td><td>27</td><td>28</td><td></td><td></td><td></td> </tr> </tbody> </table> ※Spring vacation : Feb 2~Mar 31		February							mon	tue	wed	thu	fri	sat	sun					1	②	③	4	5	6	7	8	⑨	⑩	⑪	12	13	14	15	⑯	⑰	18	19	20	21	22	㉒	㉓	25	26	27	28				2~	Spring vacation (until March 31)							
February																																																											
mon	tue	wed	thu	fri	sat	sun																																																					
				1	②	③																																																					
4	5	6	7	8	⑨	⑩																																																					
⑪	12	13	14	15	⑯	⑰																																																					
18	19	20	21	22	㉒	㉓																																																					
25	26	27	28																																																								
			Autumn Semester Make-up Exams (mid to end of February)																																																								
		28	<senior> Grades released/ Self evaluation for graduation (until March 28)																																																								
		28 · Mar 1	<senior> deadline for Request for Grade Review of 2012 one-year courses and Autumn Courses																																																								
<table border="1"> <thead> <tr> <th colspan="7">March</th> </tr> <tr> <th>mon</th><th>tue</th><th>wed</th><th>thu</th><th>fri</th><th>sat</th><th>sun</th> </tr> </thead> <tbody> <tr> <td></td><td></td><td></td><td></td><td>1</td><td>②</td><td>③</td> </tr> <tr> <td>4</td><td>5</td><td>6</td><td>7</td><td>8</td><td>⑨</td><td>⑩</td> </tr> <tr> <td>11</td><td>12</td><td>13</td><td>14</td><td>15</td><td>⑯</td><td>⑰</td> </tr> <tr> <td>18</td><td>19</td><td>⑳</td><td>21</td><td>22</td><td>㉒</td><td>㉓</td> </tr> <tr> <td>25</td><td>26</td><td>27</td><td>28</td><td>29</td><td>⑳</td><td>㉑</td> </tr> </tbody> </table> ※Spring vacation : Feb 2~Mar 31		March							mon	tue	wed	thu	fri	sat	sun					1	②	③	4	5	6	7	8	⑨	⑩	11	12	13	14	15	⑯	⑰	18	19	⑳	21	22	㉒	㉓	25	26	27	28	29	⑳	㉑	15	Announcement of Graduating Students on Loyola Notice of students repeating a year sent out (to the guarantor)							
March																																																											
mon	tue	wed	thu	fri	sat	sun																																																					
				1	②	③																																																					
4	5	6	7	8	⑨	⑩																																																					
11	12	13	14	15	⑯	⑰																																																					
18	19	⑳	21	22	㉒	㉓																																																					
25	26	27	28	29	⑳	㉑																																																					
		16~29	<juniors> Grades released/ self evaluation for graduation																																																								
		17~29	<sophomores> Grades released/ self evaluation for graduation																																																								
		18~29	<freshmans> Grades released/ self evaluation for graduation																																																								
		26	Graduation Ceremony																																																								
		29	Deadline for "Request for Grade Review for 2012 one-year courses and Autumn Courses																																																								
		31	Autumn Semester ends																																																								

● Frequently Asked Questions

Q Which offices I should go to with my questions?

A The following list shows offices and their services ; for the locations of offices, see p.10

Information and advice on course enrollment, grades, classes, credits	Center for Academic Affairs (Academic Services) (1st floor, Bldg. No.2)
Certificates, Student ID Card, change of address, tuition and fees	Center for Academic Affairs (Academic Records) (1st floor, Bldg. No.2)
Clubs/circles, part-time jobs, volunteer activities, extracurricular activities, scholarships	Center for Student Affairs (1st floor, Bldg. No.2)
Student exchange programs, Overseas short-term language programs, and other programs	International Liaison Office (1st floor, Bldg. No.2)
Teaching license, Curator license courses	Center for Certification Programs (1st floor, Bldg. No.2)
PC Login password, how to use PC room and moodle	Media Center (3rd floor, Bldg. No.2)
Lost and found	Information Service Office (ISO) (1st floor, Bldg. No.2)
Job search activities, career options, seminars	Career Center (1st floor, Bldg. No.2)
Injury, illness, health counseling, medical exam certificate	Health Center (2nd floor, Hoffmann Hall)
Problems and difficulties of student life	Counseling Center (3rd floor, Bldg. No.10)

Q How should I contact my teachers?

A Check the faculty status of your teacher, full-time or part-time, on the List of Instructors (履修要覧 共通編 p.220); Names marked with an asterisk “*” are part-time lecturers.

Full-time faculty: check their offices on the List of Offices of Instructors/Departments on p.83, 履修要覧 共通編 p.204 and inquire in person; personal e-mail addresses of full-time teachers are not released.

Part-time lecturers: they do not have offices at Sophia please bring your Student ID Card and ask at Center for Academic Affairs (Academic Services), whether or not the teachers have their contact addresses released for students.

Q Where and when can I get information and advice on course enrollment?

A Academic Services of the center for Academic Affairs Provide Information and advice on course enrollment (no telephone inquiries about course enrollment, grades, credits etc. are accepted). Please visit the office during the office hours on weekdays, 9:30 to 11:30, 12:30 to 17:00.

Q I went to the classroom listed on the Timetable, but a different class was in session.

A The classroom may have been changed. Check the updated classroom information on Loyola, “Class Bulletin Board” and “Course Schedule”.

Q The class period has started, but the instructor is not at the classroom; what should I do?

A First, check on Loyola for cancelled classes.

If your class is not on the list of cancelled classes, and the instructor does not come to class 30 minutes past the scheduled start of class, please notify Center for Academic Affairs and follow their instructions.

Q I have to be absent from class for family bereavement; is there a notice for authorized absence I should hand in?

A Sophia University does not have any system for authorized absence from class or notice of pre-approved absence.

If you were absent from class due to unavoidable reasons, please see your class instructor in person and explain the situation. The Center for Academic Affairs cannot relay your message of absence from class; when you return to university, contact your class teachers of the courses you are taking (if you were absent because of infectious illness, see p.16). If you were absent during Final Exams period, you may be eligible for a make-up exam (p.27~).

Q I want to know the schedule of university holidays and final exams, etc.

A Please refer to 2012 Yotsuya Academic Calendar (p.7)

● Office sections you should direct your inquiries to:

The following list shows the various sections of Center for Academic Affairs and their services:

Inquiries on:	Section/desk numbers
Teacher's license, curator certification program	Center for Teaching and Curator Credentials desk
Course registration, grades, classes, credits	Center for Academic Affairs (Academic Services) No.① sections for each Department
Certificates, Student ID Card, change of address, leave of absence, study abroad etc.	Center for Academic Affairs (Student Registry) No.②
Tuition and fees	Center for Academic Affairs (Tuition & fees) No.④

(※) In general, students should visit the office for inquiries; telephone inquiries are not accepted particularly on course enrollment, grades etc.

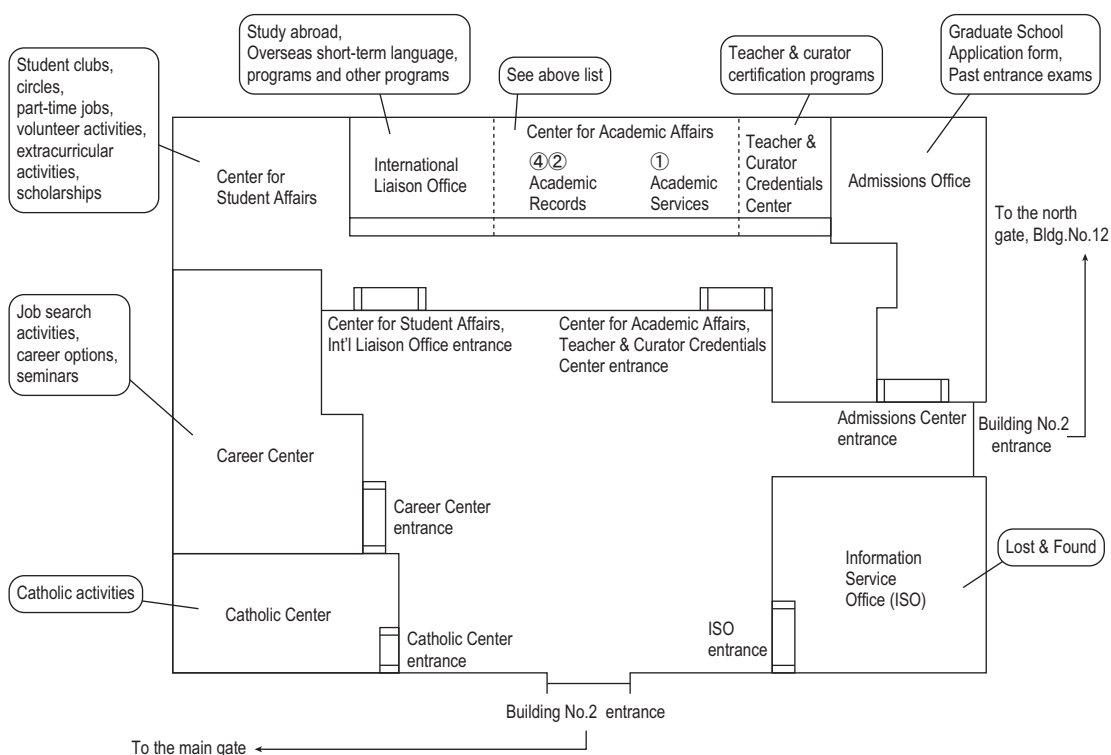

● Office Hours

Mon.- Fri.	Morning 9 : 30~11 : 30	Afternoon 12 : 30~17 : 00
------------	-------------------------------	----------------------------------

- ※ Services are available only during the above office hours for providing information, accepting applications and required documents.
- ※ Offices are closed on Saturdays, Sundays and national holidays.
- ※ Office hours during summer, winter vacations and on special circumstances are announced on Loyola Bulletin Board for Center for Academic Affairs (Academic Services)

● Announcements and Notices

Problems all announcements from the university to students will be posted electronically on Loyola Bulletin Board. Any disadvantages that may arise from failure to check the Loyola bulletin board are the responsibility of individual students.

All announcements on class information (cancelled classes, make-up classes, temporary change of classrooms, notices on exams and reports), messages to individual students or important urgent notices are posted on Loyola. Please check Loyola Bulletin Board everyday for the updated information from the university. Written announcements may also be made through the bulletin boards located within Yotsuya Campus. Please check the locations of the campus bulletin boards p.75.

<Loyola Bulletin Board> Important announcements are posted; check everyday!

Bulletin Boards	Information posted
Class Bulletin Board	Change of classrooms, notices from class teachers ※For cancelled classes, make-up classes, see “Cancel & Make up class” Students can only check information for the courses they have registered for.
Individual notice	Messages to individual students from various offices; if paged, respond immediately
University Bulletin Board	Information on events related to Sophia; announcements from the university
Faculty and department office	Announcements from each Department /Program
Academic Services	Important announcements on course registration, changes of curriculum
Academic Records, Tuition	Announcements regarding academic records, tuition and fees, certificates

<Other information available on Loyola>

Information	Menu for inquiry
Check my classroom	Cancel & Make up class / Course Schedule
Check the cancelled class, make-up class, temporary change of classroom	Cancel & Make up class / Course Schedule
Check the syllabus	Syllabus Inquiry
Register for courses; check the data I entered for course registration	Course registration — Course Registration, status of course registration Inquiry
Check my grades	Grades — Grade Inquiry
Use self-evaluation function	Course registration — Self Evaluation
Check Final Exam schedule, report assignment	Final Exams —Final Exams Time table Inquiry
Learn various functions of Loyola and how to operate them.	Loyola Handbook

● Guidance programs

At University, students are expected to decide and to plan their own studies. There are various guidance programs held at the beginning of the academic year to help them in course selection, registration, give information on curriculum content, and study activities. Be sure to attend. The following are the main guidance programs:

Students	Should attend the guidance programs:
Freshmen	Freshmen guidance
Sophomores -Seniors	Current students guidance
Intending to take teaching license course	Teaching license course orientation (April) Guidance session for new students of teaching license course (September)
Intending to take curator license course	Guidance session for new students of curator license course

Additional guidance programs may be offered as necessary.

● How to contact your teachers

The class teachers are either full-time faculty of Sophia or part-time lecturers from other universities coming to teach the particular course. If a student wishes to contact his/her teachers, the following are the ways depending on whether they are full-time or part-time:

■ Full-time faculty:

Full time faculties have offices on campus and individual office hours for talking with students. If you need to make an appointment outside of office hours, contact your Department office for instructions.

Also, there are Class advisor for each undergraduate class or seminar. The students may seek their advice on the studies, course enrollment, career options and any difficulties in student life.

- List of teachers' offices and their office hours : 履修要覧共通編 p.204～
- Department offices : 履修要覧共通編 p.204～ (listed first on pages of each Department)
- List of principal class teachers of Departments : 履修要覧共通編 p.202

■ Part-time lecturers

Part-time lectures do not have offices on campus; contact them before or after classes. Some teachers may release their personal e-mail addresses to students.

Information on whether or not a teacher releases contact address, and if so, the address itself, are available at Center for Academic Affairs (Academic Services). Students should bring your Student ID Card and inquire at the desk.

For protection of personal information, office does not accept telephone inquiries.

The Center for Academic Affairs does not relay messages from students to their teachers.

■ If you do not know whether the teacher you wish to contact is full-time or part-time teacher:

Please check the list of courses with names of class teachers (履修要覧共通編 p.220～) to see whether the teacher is full-time / part-time.

The teachers with an asterisk “*” in front of their names are part-time lecturers; those without an asterisk are full-time faculty.

● Notice of change of address

If there are any changes in address, telephone number of the student or the guarantor, please notify Center for Academic Affairs (Academic Records) by submitting a form available at the Center. The students must notify the office to receive postal mail sent from university at the new address.

If a student intends to go on a study abroad and there is a change in the address or that of the students guarantor, submit the notice of change of address before going abroad.

● When public transport service is shut down

When public transport service is shut down due to natural disasters such as typhoon, heavy rain falls by accidents or strikes, and it is difficult to hold classes or final exams, special measures will be taken to cancel classes or change exam schedules. The special measures will be announced on university official website, Loyola or official Facebook page; the students are responsible for checking the websites for information.

● Personal Information

For policy on protection of personal information of Sophia School Corporation, visit the following site:
http://www.sophia.ac.jp/jpn/info/privacypolicy/joho_toriatsukai

Academic Services

1. Courses ... P. 14

Duration of Courses / Duration of Semester/
Class Hours / “Virtual Days” / Classes on
National Holidays / Classrooms/ Textbooks/
Class Cancellation/Make-up Classes/Absence
from Class/ Infectious Disease/ Absence from
Class due to Selection as Citizen Judge/

2. Credits and Courses ... P. 17

Credits/Course Composition/ Course Types

3. Graduation Requirements and Self Evaluation/Change of Category ... P. 18

Graduation Requirements/
Check credits required for graduation/
Self-Evaluation.Change of Category

4. Course Registration ... P. 20

Course Registration Schedule/ Course
Registration / Maximum credit limit/
Repetition of Courses/ Lottery Courses/
Points to be noted for Course Registration

5. Enrollment in courses offered by Faculty of Liberal Arts ... P. 23

Enrollment eligibility/ Supporting documents/
Application Procedure for Course Enrollment/
Summer Session

6. Course Withdrawal ... P. 24

Course Withdrawal/ Course Withdrawal
Period/ Points to be noted

7. Examinations ... P. 26

Types of exam/ Announcement of Schedule of
Final Exams (written exam)/ Report Exams/
Policy of Final Exams (written exam)/ Cheating
in Final Exams (written exam) is forbidden/ If
public transport service is shut down/ Make-up
Exams/ Cheating in Report Exams is forbidden/
Stance on Exams, Reports, Papers.

8. Evaluation / Grades ... P. 31

Evaluation Criteria/ GPA/ Grades Release
Dates/ Request for Grade Review/ Students
with no prospect of academic progress

9. Course Continuation System ... P. 33

Course Continuation/ Application Procedures/
Requirements

10. Credit Transfer and Approval ... P. 34

Credit Transfer and Approval/
Grades of Courses with Transferred Credits/
Transfer of Pre-matriculation Credits/
Credit Transfer of Transfer Students/
Credit Transfer for Teacher Certification
Program/ System of Graduate School
Pre-admission Course Enrollment/ Credit
Transfer by Student Exchange Agreement/
Credit Transfer from Study Abroad/

11. Overseas Short-term Language/ Programs/Short-term Study Abroad Programs ... P. 37

Credit Transfer by Overseas Short-term
Language Program/ Credit Transfer by
Overseas Short-term Training Program

1. Courses

● Duration of Course

The duration of course in one academic year is basically 35 weeks including the final exam period. For the first and last dates of courses and the final exam period, please check on p.6-7, “2012 Yotsuya Campus Academic Calendar”.

● Duration of Semester

The duration of semesters is as follows:

Spring Semester : April 1 to September 20

Autumn Semester: September 21 to March 31

● Class Hours

Class period	Hours
1	9 : 15~10 : 45
2	11 : 00~12 : 30
3	13 : 30~15 : 00
4	15 : 15~16 : 45
5	17 : 00~18 : 30
6	18 : 45~20 : 15

※ Exceptions to the above regular class days and hours are Intensive Courses held on Saturdays, vacations, Sundays or during make-up class period. The dates, hours and classrooms for these courses are announced on Loyola. (These courses are listed on the Course Schedule as “Intensive Course”)

● “Virtual Days”

“Virtual Days” are scheduled to make up for classes with insufficient number of classes as they fall on certain day of week of national holidays; classes are held on a day of week different from that of the original schedule.

For the 2012 virtual days. Please check 2012 Academic Calendar (p.6~).

● Classes on national holidays

Classes may be held on national holidays to ensure that sufficient numbers of classes are held. For classes of 2012 Academic Year held on national holidays, please check on 2012 Academic Calendar (p.6~).

● Classrooms

Classes are basically held in classrooms shown on Loyola. However, there may be changes in classrooms, temporary and for the whole semester due to the number of attending students or installed equipment. At the beginning of a semester, there may be frequent classroom changes. Please make it a habit to check the classroom on Loyola before you go to your classes.

- Changes of classrooms for the whole semester
The new classrooms and the dates of changes will be posted on Loyola Bulletin Board.
Please also check the changes on Loyola “Class Schedule” or “Cancelled or Make-up Classes Inquiry”
- Temporary changes of classrooms
Please check on Loyola “Cancel & Makeup class”

● Textbooks

The textbooks necessary for classes and reference books will be listed on Loyola “Syllabus Inquiry”. If you are not required to have them prepared before classes start, follow the instructions of the teacher on the first day of class. The textbooks and reference books are available at on-campus bookstore, Maruzen Sophia shop (B1 floor, Bldg. No.2). At the beginning of the semester special booth for selling textbooks will be installed on the B1 floor.

● Class Cancellation

If a class teacher cannot hold classes for reasons such as official duty, official trip, academic meeting, or illness, the classes may be cancelled. Class cancellation will be announced on Loyola when the class teacher notifies the office. However, the teacher may notify the office on the day of class, so please make sure to check Loyola before you go to your classes every day. You can check the class cancellations on the day of class on Loyola from your mobile phones.

If your class is not on the cancelled class list on Loyola, but the teacher does not appear in class 30 minutes after the scheduled starting time, please notify Center for Academic Affairs and follow the instructions.

● Make-up Classes

In general, make-up classes are held on make-up class days specified in Spring and Autumn Semesters, but they may be held on days other than the scheduled days. In both cases, the classroom, date and time of make-up classes will be announced on Loyola. Please check Loyola before you attend the make-up class.

For the 2012 Make-up classes, check the 2012 Academic Calendar (p.6~)

● Absence from Class

Sophia University does not have any system for authorized absence from class or notice of pre-approved absence. If you were absent from class due to unavoidable reasons such as bereavement, delay in public transport service, illness, extracurricular activities, job search, please see your class teacher in person and explain the situation. The Center for Academic Affairs cannot relay your message of absence. If you are absent during Final Exams period, you may be allowed to take a make-up exam (p.27~).

If you need to be absent over a long period of time due to illness or injury, consult the Department Chairperson or your class advisor. (p.83 or 履修要覧共通編 p.202~).

● Infectious disease

When students contract an infectious disease defined by School Health and Safety Act, the students are not allowed to come to school for a certain period of time to prevent the spreading of the disease. If you contract such disease, take the following steps:

If students contract a new infectious disease such as new strain of influenza, special measures may be taken; check announcements on Loyola and university official Website.

1. You must follow your physician's instructions and stay home until there is no risk of infection. Please call the Health Center to notify your situation (03-3238-3394).
2. Download the "Permission to return to school after completion of treatment of infectious disease" (感染症治療後登校許可証明書) from university official website, and have it filled out by your physician. (a form of any medical organization may be used if it states the period student is not allowed to go to school.
※ If you cannot download the form, ask for the form at Health Center.
3. When you return to school, submit the above original certificate to Health Center, and photocopies to each of your class teachers.

● Absence from Class due to Selection as Citizen Judge

The citizen judge system introduced in recent years according to "Act on Criminal Trials Examined under Citizen Judge System" allows students to decline to serve as citizen judges. However, to respect the intentions of students selected wishing to serve as citizen judges, students may serve under following procedures:

1. Students who may apply:
Full-time undergraduate or graduate degree students of Sophia University and non-matriculated students (excluding auditing students).
 2. Reasons justified for applying
 - 1) To report to the court for selection procedures of citizen judge candidates
 - 2) To serve as citizen judge in a court
 - 3) To attend a court as supplementary members of citizen judges
 3. Procedures
In general, students should visit Center for Academic Affairs (Academic Services) in advance; pick up the request form for absence from class due to selection as citizen judge; fill out and submit the request form and a copy of the letter sent from the courthouse "Notice of day for selection procedures (summons)" to your class teacher and ask to be excused from that class; when you complete your service as citizen judge, report to your class teacher by submitting the certifying document issued by the court.
 4. Absence from class
When the student follow the above procedures, the teacher will process the absence as follows so that the student will not be at a disadvantage.
 - 1) Classes: student will not be considered "absent"; providing any alternative measures will be the discretion of the teacher.
 - 2) In-class exam: student will not be considered "absent"; providing any alternative measures will be the discretion of the teacher.
 - 3) Final exams: student may take make-up exam; must follow the usual procedures and submit a request for make-up exam
- * For reference:
Students are eligible to be selected as citizen judge candidates but the law defines that they may decline to serve. The options for appearing at court are as follows:
(Options for students)
- a) You may follow the selection procedures of citizen judge and participate in court as a citizen judge.
 - b) You may decline to serve because you have the student status.
 - c) You may decline to serve if summoned during final exam period or any other specific month or day (Reasons justified for declining to serve)
 - You have a reason for declining to serve justified for the whole year.: namely the status of "student".
 - You have a specific month in which it is extremely difficult to serve as citizen judge; during final exams
 - You have an important service in social life that cannot be performed on any other date.

2. Credits and courses

● Credits

All courses are given a certain number of credits; if you take the courses and pass the exams, you will earn the credits. The calculation method of credits varies depending on the type of course. The numbers of credits you may earn for the course you register for are given in the “Bulletin of Information” on sections for each Department or sections of *Zengaku Kyotsu Kamoku* (General Studies courses) with list of instructors.

The number of credits required for graduation varies depending on the Department and Matriculation Year. You must check the requirements on the sections of your Department “1. Courses and minimum number of credits required for graduation”, “2. Standard course distribution list”.

Based on government requirements of Standards for Establishment of Universities and Article 22 of Sophia University Regulations, “a study of 45 hours is required to earn one course credit”. This means that students are required to study a number of hours other than the actual class hours.

● Course Composition

Courses are divided into two main groups; General Studies (*Zengaku-Kyotsu-Kamoku*) courses offered by all Faculties and Specialized Education courses offered by each Department.

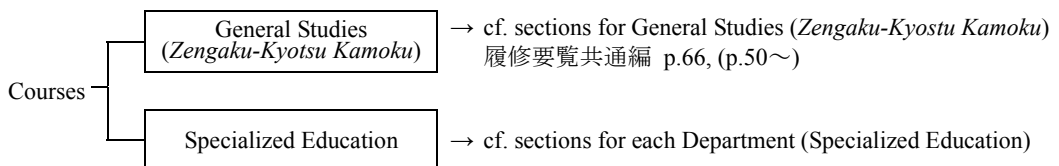

● Course Types

General Studies (*Zengaku-Kyotsu Kamoku*) and Specialized Education are divided into four categories

Compulsory courses	You must take these courses
Elective Compulsory	You may choose of several courses from this category to meet the credit requirements set by each Department
Electives	You may select the courses
Optional courses	You may take courses that interest you academically or personally (credits will not be counted into graduation requirements)

The credit requirements vary by Department. For more details check the sections for your Department on “1. Courses and minimum number of credits required for graduation” and “2. Standard course distribution list”

3. Graduation Requirements, Self-Evaluation/Change of Category

● Graduation Requirements

Students enrolled in Sophia University must meet the following two requirements to earn credits and graduate from university: if you fail to meet either of the requirements, you will not be able to graduate and will need to repeat a year or a semester.

- 1 : To satisfy the residence requirement
(4 years; may vary for transfer, re-entry, second-degree admission students)
- 2 : To take courses specified and obtain credits for graduation requirements
(courses and credits required for graduation vary depending on your Department and the year in which you were admitted)

● Check credits required for graduation

Students are responsible for creating their course registration plan and to meet the above graduation requirements, students also must check that the plan satisfies all graduation requirements.

The Center for Academic Affairs offers advisory service on course registration, but the office will not be responsible for checking on graduation status and credit requirements or calculation for individual student. Students are responsible for checking whether or not you are able to graduate.

● How to check credits required for graduation

- 1) Check on Bulletin of Information
The courses and credits required for graduation vary depending on your Department and matriculation year. Please read thoroughly the sections for your Department and matriculation year in the Bulletin of Information (for each Department) on “Courses and minimum number of credits required for graduation”, “Standard course distribution list”, “Notes on Taking Courses ”; check for each course you have taken and the credits earned to which category of credits required for graduation they apply.
- 2) Check on Loyola “Self evaluation” function
When you have checked on the Bulletin of Information as shown in 1) above, please also check on Loyola “Self Evaluation” function as follows:
 - “Self Evaluation” function:
You may check on Loyola your status of courses taken and credits earned for each category of graduation requirements by calculating the missing number of credits you need for graduating from the sum total of credits of courses you are currently taking and the credits you have earned so far.
This function makes it simple and easy for you to check the number of credits required for graduating; however, it is a calculation of credits on the computer system and it is not a service to ensure graduation.
 - “Self Evaluation” may not work for certain cases
Some Departments have complicated curriculum and the calculation/display may not work properly. For more details, please check on Loyola Bulletin Board (Academic Services) “Points to be noted on Self-Evaluation screen”.
 - Self Evaluation function available period
Self Evaluation function on Loyola is available for a designated period only.
Please note it is not available during course registration period or withdrawal period (seniors may use the self evaluation function during course registration period).
For the schedule of available periods of 2012 Academic Year, please check on Loyola Bulletin Board (Academic Services)

● “Change of category” on Loyola Self Evaluation screen

The categories here are the two major groups of courses, namely General Studies (*Zengaku-Kyotsu-Kamoku*) courses and Specialized Education courses.

“Change of category” is allowed for courses which you may select to take as either General Studies (*Zengaku-Kyotsu-Kamoku*) courses or Specialized Education courses and you wish to change the category according to the graduation requirement. Note that repeating a year by using Loyola “Change of category” is not possible.

■ Courses for which “Change of category” is permitted

Courses for which “Change of category” is permitted are set follows:

(The Change of category menu shows only courses permitted for the change of category)

	Category when you registered for the course	Category may be changed to:
Gaku-zen courses (offered by Departments for all students)	Specialized elective (other Faculties/Departments) [Other = courses offered also for students of other faculties/departments]	General Studies (<i>Zengaku-Kyotsu-Kamoku</i>) courses (Gaku-zen courses) [General Studies (<i>Zengaku-Kyotsu-Kamoku</i>) courses – Electives – Gaku-zen]
Foreign Languages	General Studies (<i>Zengaku-Kyotsu-Kamoku</i>) courses [General Studies (<i>Zengaku-Kyotsu-Kamoku</i>) courses – Foreign Language courses – e.g., English]	Specialized Electives [Specialized Electives – Foreign Languages – e.g., English]

Courses other than the above for which change of category may be permitted vary depending on the Department. Please refer to the sections for each Department of the Bulletin of Information.

The above does not apply to the Faculty of Liberal Arts. For more information, please check Loyola Bulletin Board (Academic Services).

In recent years, there are cases of students who realize just before their graduation period that they are not eligible to graduate due to serious misunderstandings of credits required for graduation (or the number of credits they are taking).

Students are responsible to plan their course enrollment plan well using the Self Evaluation function and Bulletin of Information as shown above. If a student has any questions, inquire as soon as possible at Center for Academic Affairs (Academic Services)

4. Course Registration

Students must register for courses for Spring and Autumn Semesters on Loyola during the period set for course registration.

More information on procedures of Loyola and points to be noted about course registration are given on “Handbook of Course Registration” (履修登録の手引き) and “Loyola Handbook” online. Read thoroughly to avoid registration errors.

■ Schedule for Spring Semester course registration 2012

registration	period	notes
Pre-registration	First lottery < sophomores, juniors, seniors > April 3 (Tue) 10:00 – 6 (Fri) 21:00 First lottery < Freshmen > April 7 (Sat) 6:00 – 9 (Mon) 21:00 Second lottery < All students > April 10 (Tue) 12:00 – 21:00	If a student intends to register for lottery classes of Spring Semester and One-year courses, he/she must register during the Pre-registration period on Loyola.
Results of Pre-registration available	< All students > First lottery: April 10 (Tue) 12:00 – Second lottery: April 11 (Wed) 13:00 –	Check the results of lottery pre-registration on Loyola
Course registration	< Juniors/ Seniors > April 12 (Thu) 10:00 – 18 (Wed) 21:00 < Freshmen/Sophomores > April 13 (Fri) 10:00 – 18 (Wed) 21:00	If you intend to register for Spring Semester and One-year courses (except for lottery courses) you must register during this period on Loyola.
Results of course registration	< All students > April 19 (Thu) 10:00 –	Check the results of course registration on Loyola
Change of course category, Self evaluation period (for seniors only)	April 19 (Thu) 10:00 – 23 (Mon) 21:00	Change of category and Self evaluation on Loyola are limited to seniors only (cf. 履修要覧共通編 p.24)
Course Adjustment	< All students > April 21 (Sat) 10:00 – 23 (Mon) 21:00:	Make adjustments to the course registration results on Loyola.
Final confirmation of course registration	< All students > April 25 (Wed) 13:00 –	Check the results of course adjustments on Loyola

■ Schedule for Autumn Semester course registration 2012

registration	period	notes
Pre-registration	First lottery < All students > September 21 (Fri) 10:00 – 24 (Mon) 21:00 Second lottery < All students > September 25 (Tue) 12:00 – 21:00	If a student intends to register for lottery classes of Autumn Semester, he/she must register during the Pre-registration period on Loyola
Results of Pre-registration available on Loyola	< All students > First lottery: Sept 25 (Tue) 12:00 – Second lottery: Sept 26 (Wed) 13:00 –	Check the results of lottery pre-registration on Loyola
Course registration	< Juniors/ Seniors > Sept 28 (Fri) 10:00 – Oct 4 (Thu) 21:00 < Freshmen/Sophomores > Sept 29 (Sat) 10:00 – Oct 4 (Thu) 21:00	If a student intends to register for Autumn Semester courses (except for lottery courses) he/she must register during this period on Loyola.
Results of course registration	< All students > October 5 (Fri) 10:00 –	Check the results of course registration on Loyola
Change of course category, Self evaluation period (for seniors only)	October 5 (Fri) 10:00 – 8 (Mon) 21:00	Change of category and Self evaluation on Loyola are limited to seniors only (cf. 履修要覧共通編 p.24)
Course Adjustment	< All students > October 7 (Sun) 10:00 – 8 (Mon) 21:00	Make adjustments to the course registration results on Loyola.
Final confirmation of course registration	< All students > October 10 (Wed) 13:00 –	Check the results of course adjustments on Loyola

● Course registration

Course registration is the procedure for students to select the courses they intend to take (attend classes) and register for the courses within a given period. To register for courses there are two separate periods, “pre-registration” for lottery courses and “course registration” for courses other than the lottery courses.

If a student makes registration errors, he/she will not be allowed to take the courses and no grades or credits will be given; students should exercise caution when registering for courses. Please read thoroughly “Handbook of Course Registration” (履修登録の手引き) and “Loyola Handbook” before registering.

To avoid registration errors, login to Loyola after the registration has been completed again and check that the courses you wish to take are registered. It is recommend that the students print out and keep a copy of the registration screen.

Any notices or announcements on course registration will be posted on Loyola Bulletin Board (Academic Services)

● Limit on Number of credits to be registered

The number of credits a student may register for in a semester and in a year has an upper limit (maximum credit limit), so that the students will be able to have sufficient study hours to earn the credits and maintain academic level of their study.

Maximum credit limits vary depending on the Department and matriculation year; please check on the “Notes on Taking Courses” of your Department in p.58～

- ※ Maximum credit limit is the upper limit of credits a student may register for. It includes courses attempted for which he/she did not earn credits (courses the student withdrew from (W) and courses that were given a grade of F).
- ※ The credits for One-year courses should be divided proportionally (halved) to Spring and Autumn Semesters.
- ※ When Spring Semester maximum credit limit + Autumn Semester maximum credit limit > Annual maximum credit limit, if you register for credits for Spring Semester and Autumn Semester within the maximum credit limits respectively, the annual maximum credit limit should not be exceeded.

■ Example of calculating maximum credit limit

Spring	Autumn	Annual
26	26	44

If a student registered in the Spring Semester for 4 credits of One-year courses and 18 credits of Spring Semester courses:

→ the total credits registered for in the Spring Semester will be $18+2=20$ credits.

→ In Autumn Semester the student is allowed to register for only up to: the following if this is the case.

Annual maximum credit limit (44 credits) – Spring Semester (20 credits) – One-year course (2credits) = 22 credits

The above calculation is an example only. Please read thoroughly the pages of your Department to create your annual course enrollment plan

● Repetition of a Course

If a student repeats a course (take a course with the same course number) it will not be approved as credit required for graduation.

In general, it is not allowed to take a course for which a student has already earned credits, but there are some exceptions.

For more information, refer to the sections for each Faculty/Department and for General Studies (*Zengaku-Kyotsu Kamoku*) courses.

● Lottery courses

Lottery courses are courses with limited class capacity.

The class capacity is indicated on the Notes column as “number of students” on the List of courses offered with names of instructors.

If a student wishes to take lottery courses, he/she must register for the courses during the Pre-registration period of each Semester.

Lottery is conducted by computers, successful students are automatically registered for the course.

If a student are successful a lottery course, the student cannot cancel the course. However, if it is not a compulsory course a student may withdraw from the course during the course withdrawal period.

● Points to be noted for Course Registration

■ Carefully plan your course enrollment

Create your annual course enrollment plan based on the credits you have earned up to the previous year (for sophomores or above) and referring to Bulletin of Information and syllabi.

Plan the course enrollment for the whole year to avoid registering for One-year course in the Spring Semester and finding out you have a compulsory course to take on the same day of week at the same class period in the Autumn Semester.

When creating your course enrollment plan, keep in mind the maximum credit limits per semester or year. (cf. p.● “maximum credit limits”)

■ Be sure to register during Course Registration period

Students must register for courses they intend to take during the prescribed period. (Article 50, University Regulations)

As stated in Article 50 of University Regulations, a student cannot register for courses except during a given period. Please note carefully, the course registration period may vary each year.

■ Read thoroughly the “Handbook of Course Registration” (履修登録の手引き) and observe office hours for making inquiries.

Prior to the Course Registration period the “Handbook on Course Registration” will be posted on Loyola Bulletin Board (Academic Services). It has important information on course registration schedule, procedures, and points to be noted; download from Loyola and read it thoroughly.

If you have any questions on course registration, visit the Center for Academic Affairs (Academic Services).

Telephone inquiries are not accepted.

■ Students must attend the first class meeting.

Attendance to the first class meeting is mandatory, as the instructor gives important information on class schedule, evaluation method etc.. Some teachers may take attendance on the first class meeting which will be counted in the evaluation (stated on syllabus). If a student does not attend the first class meeting, in some courses he/she may not be allowed to attend the classes at all. If this happens, the student must withdraw from the course; course registration is never deleted automatically.

■ Check the results of course registration

If a student register for a course but made errors and registration was not successful, he/she will not be given any grades or credits even the student has attended.

Students are solely responsible for successful course registration. To avoid registration errors, be sure to check the results of course registration in the given periods and if any errors are found, make adjustments in the course adjustment period.

5. Enrollment in courses offered by Faculty of Liberal Arts

● Course Enrollment Eligibility

Students are eligible to take the courses if you meet one of the following requirements:

	Requirements	Supporting documents
TOEFL	550 (213 on Computer based; 80 on Internet based tests) or above	Official score report *
TOEFL ITP	550 or above	
TOEIC (IP also accepted)	730 or above	
The EIKEN Test in Practical English Proficiency	Grade 1 / Pre-1	Certificate or Certification Card*
Placement Test	Test given at entering Sophia; those who were placed in advanced level	Indicate on Request for Course Enrollment form
When you have participated in an Exchange program study abroad at affiliated universities	Universities in English speaking countries / universities with courses taught in English	Give name of university on Request for Course Enrollment form

* photocopies are acceptable

● Supporting Documents

- 1) Request for Course Enrollment (form available)
- 2) Documents to certify eligibility for enrollment (see the list of supporting documents above)

● Application Procedure for Course Enrollment

- 1) Prior to Course Registration period, pick up Request for Course Enrollment (履修願) and FLA Course Schedule from Center for Academic Affairs (Academic Services) and create the course enrollment plan. To select the courses the student wishes to take, he/she must check the syllabus on Loyola.
 - * The following are compulsory courses for regular students enrolled in Faculty of Liberal Arts and are not available for students of other Faculties.

ENG001	BASIC SKILLS (WRITING)	ENG002	BASIC SKILLS (READING)
ENG111	ENGLISH COMPOSITION 1	ENG112	ENGLISH COMPOSITION 2
ENG115	PUBLIC SPEAKING	THP101	THINKING PROCESS
 - * Foreign language courses offered by Faculty of Liberal Arts (excluding some Japanese Language courses) are not available.
- 2) Complete the Request for Course Enrollment and submit it to Center for Academic Affairs (Academic Services) during Course Registration or Course Adjustment periods. (check the exact schedule of course registration on Loyola Bulletin Board (Academic Services)).

Pay particular attention to the following:

 - * Note carefully that once a student submits the Request for Course Enrollment, he/she cannot cancel the request. If the student decided not to attend the course he/she requested, the student will have to apply for withdrawal from the course during the withdrawal period.
- 3) If international students wish to enroll in Japanese Language courses, read 履修要覧共通編 p.155-156 on enrollment eligibility, list of courses offered and schedule of placement tests. Other students should inquire in advance at Center for Academic Affairs (Academic Services, Faculty of Liberal Arts).

● Summer Session

Students may take Summer Session courses offered by Faculty of Liberal Arts. The course registration period is Monday, June 18, to Friday, June 22, 2012. Summer Session courses are not counted into maximum credit limits per semester or year. More information on registration procedures and programs will be posted on Loyola Bulletin Board (Academic Services) in early June.

List of courses offered are given on 履修要覧共通編 p.410.
Summer Session courses charge separate tuition and fees.

6. Course Withdrawal

● Course Withdrawal

If a student attended classes but wish to reduce the class load because 1) the class subject is not what you had expected, 2) the student realizes he/she does not have sufficient knowledge to follow the class work, 3) the student have decided to he/she change the course enrollment plan, you may apply for withdrawal from class during the given period.

Withdrawal from courses may be done either on Loyola or at the Center for Academic Affairs (Academic Services) by (submitting a form “Request to withdraw from course” 履修中止願).

● Course Withdrawal Period

course withdrawal periods for the 2012 Academic year are as follows:

Period	Applies to courses
June 8 (Fri) 10:00 – 13 (Wed) 21:00	One-year courses/Spring Semester courses (excluding compulsory courses)
December 9 (Sun) 10:00 – 14 (Fri) 21:00	One-year courses, Autumn Semester courses (excluding compulsory courses)

● Points to be noted for course withdrawal

- Courses from which the students are not allowed to withdraw
Students are not allowed to withdraw from compulsory courses of Zengaku Kyotsu General Studies courses or Specialized Courses.
In principle the students are not allowed to withdraw from General Foreign Language courses. (for more information, refer to sections on “General Foreign Language” (一般外国語) of 履修要覧共通編
However, some Departments have courses other than compulsory courses from which the students are not allowed to withdraw or compulsory courses from which they are allowed to withdraw.
For more information, refer to “Points to be noted on course enrollment” on sections of each Department in Bulletin of Information and Guide on Course Withdrawal posted on Loyola Bulletin Board (Academic Services)
- The students can withdraw from courses during the withdrawal period only. Once, submitted the cancellation of the course withdrawal is not possible.
During Course Withdrawal period, cancellations of withdrawal can be done online (Loyola), but no change can be made after the deadline.
If a Student wishes to withdraw courses, apply early to allow enough time for erision of your withdrawal during the course withdrawal period. He/she may register for the same courses again in the following academic year of later.
- Withdrawal from Lottery courses.
If a student was successful in registering for a lottery course but wish to withdraw from the course, he/she may do so during withdrawal period (except for compulsory courses and courses the student is not allowed to withdraw from)
- Courses withdrawn are counted into maximum credit limit
The credits for withdrawn courses will be counted into maximum credit limit per semester or year.
When registering for courses in Autumn Semester, include the credits of withdrawn courses to the course enrollment plan and keep the total number of credits within the maximum credit limit.
- Read thoroughly the “guide on course withdrawal” and if there is any have questions, inquire at the office within office hours
Prior to Course Withdrawal period, guide on course withdrawal will be posted on Loyola Bulletin Board which gives important information on the schedule of course withdrawal and points to be noted. Download the guide from Loyola and read it thoroughly.
For any questions on course withdrawal, inquire at Center for Academic Affairs (Academic Services).
Telephone inquiries are not accepted

- Check the results of the course withdrawal
Cancellations after the Course Withdrawal period or any withdrawal from other courses are not accepted. To avoid application errors, login to Loyola again after completing the course withdrawal procedure online and check that the course withdrawal is completed. We recommend the students to print out and keep a copy of the screen.

7. Examinations

● Types of examination

Examinations are held in during the semester and end of term in Spring and Autumn Semesters in the following types:

Type of exam	Exam period / deadline of submission	Announcements of schedule etc.	Make-up exam	Notes
In-class Examinations	Any time during class sessions (usually on last day of class)	Given in class by the class teacher	Not applicable	Foreign Language courses usually have in-class exams
Final Examinations (written tests)	During Final Exam period	Announced on Loyola by Center for Academic Affairs (see below for schedule)	Will be held	Information announced on Loyola Bulletin Board; the class teacher may give additional instructions in class.
Report Examinations	To be submitted by the deadline set at end of the term		—	

● Announcement of Schedule of Final Exams (written exam)/Report Exams

Information on “Final Exams (written exam)” and “Report Exams” will be announced on Loyola by Center for Academic Affairs as follows;

Information on In-class Exams will be announced as “Other Exams”

	Schedule announced on:	Final Exams (written test) period
Spring Semester	Tuesday, July 10, 2012	Tuesday, July 24, 2012 – Tuesday, July 31, 2012
Autumn Semester	Friday, Jan 11, 2013	Friday, Jan 25, 2013 – Friday, Feb 1, 2013

● Policy of Final Examinations (written tests)

■ Note the following for taking the exams:

- Check the exam room on Loyola; and it is the students responsibility to check and to be at the prescribed exam room.
Mobile phones and PHS must be turned off and put inside the bag. It is not allowed to use such devices as clocks to see the time.
- If you are 20 minutes late or more for the exam, you are not allowed to take the exam, whatever the reasons may be.
The scheduled exam hours will not be extended for any reasons including delay of public transport service. Allow enough time to arrive on time to the exam.
- Students are not allowed to leave the class room for the first 30 minutes and the last 10 minutes of the exam.
- No student may leave the class room unless he/she has submitted his/her answer sheet.
- If you a student does not follow instructions of the proctor or does not observe warnings to stop talking or any other misconduct, his/her exam shall be invalid.

■ Things to bring to the exam

- 1) Student ID Card: it must be placed on the desk. Without the Student ID Card, students will not be allowed to take the exam, whatever the reasons may be.
 - ※ If a students forgets his/her ID have a “Temporary Student ID Card” issued at the Automatic Certificate Issuance Machine located on 3rd floor of Building No.2 (500 yen fee charged). However, if the student cannot come to the exam room with the “Temporary Student ID Card” within 20 minutes after the start of the exam, you will be considered late for exam and will not be allowed to take the exam.
- 2) Pens/pencils
- 3) Pencil board: Only if you need to use one; white or any similar color. Using a notebook or other book as an underlay is not permitted.

- Answer sheets
 - As a rule, students are given only one answer sheet
 - If a student made errors on the answer sheet and a new answer sheet is given, he/she must return the first answer sheet.
 - Use a ballpoint or felt pen to fill out Student ID Number and your name. Answer sheets without student ID number or name are invalid

● Cheating in Final Exams (written exam) is strictly prohibited

Do not be tempted to cheat in written examinations or during in-class exams held during class sessions: If a student is found cheating in an exam, The University will impose severe punishment. The following are some actions that would be considered as cheating:

[Cheating in written examination involves]

- bringing in and using materials not permitted. (cheat sheet etc.)
- exchanging answer sheets with other students; bringing in answer sheets written prior to the exam
- taking the exam for another student or have another student take the exam for you.
- other actions that violate the rules for administering exams

Students cheating in written exams during Final Exam period shall be subject to the following severe punishments

- ① Depending on the degree of misconduct, student shall be given penalties of suspension, dismissal from university or admonitory warning
- ② Student will receive grade F (fail) for the course he/she cheated in the exam. As penalty, the grades of all other exams the student took during the exam period shall be F (fail).
- ③ The Student ID of the student who cheated shall be posted on the campus bulletin board.

[Penalties for Suspension]

- The suspended period will not be counted in the residence requirement; so, the student will not be able to graduate in 4 years (the basic residence requirement).
- Scholarships will be cancelled. Also the student's qualification for study-abroad, overseas short-term language/Study Abroad program, nominations to university-organized programs may be cancelled.

Cheating in written exams involves more than the grade for that one course; it causes a far greater disadvantage for the student involved. Cheating in exams may be an impulse; do not give in to temptation; it has grave consequences. Double check before taking an exam the materials allowed to bring in, if any, to the exam.

● If public transport service is shut down

Refer to “if public transport service is shut down” (p.18) in “Common Guidelines”

● Make-up exams

※ From Academic Year 2012, some changes have been made to the application procedures for make-up exams. Please check and note the changes.

If a student were unable to take the Final Exams for the following reasons, you may be allowed to take make-up exams by submitting “Application for Make-up Exams” (form available at center for Academic Affairs). The students will need to submit application for make-up exams during the given period, obtain permission, and pay the make-up exam fees.

No make-up examinations are applicable for foreign language courses or in-class exams (other than Final Exams period).

1) Legitimate reasons for applying for make-up exams

Normally, the legitimate reasons include illness, family emergency of third degree of kinship, disasters, delay in public transport service, and appointment of citizen judge system. The application for Make-up Exams must be accompanied by the following supporting documents to prove that the student was unable not able to come on the day of the final exam(s). The application procedure must be completed within the specified period.

2) Supporting documents and procedures

“Illness”	Medical certificate or permission to return to school issued by a physician ※ Payment receipts are not accepted
-----------	--

The document must indicate the physician’s observation on the day of the exam to prove that a student was not in a condition to take an exam. The certificate must explicitly show that the student was able to come to the exam because it was the consultation day or during treatment period. If the student had to be absent over several days, the medical certificate must show the diagnosis requiring the treatment for these days.

“Bereavement of third degree of kinship”	Funeral service card/thank you card etc. addressed to funeral guests
--	--

The cards must show the date of the exam the student was unable to take

“Delay in public transport service”	Delay certificates issued by the public transport service (indicating the date and the delayed time); a delay certificate printed out from on the Internet is accepted.
-------------------------------------	---

If the delay in public transport service was more than 20 minutes and a student arrived at the exam more than 20 minutes past the scheduled starting time, he/she may apply for a make-up exam. **The application must be submitted on the day of the delay in public transport service.**

※ Please note: the application for make-up exams will not be accepted, if applied on the day following the exam day or later.

[NB] **If a student is unable to come to the university on the day of the delay** for unavoidable reasons, or shutdown of public transport service, a “tentative application” may be made by telephone to the Center for Academic Affairs, section for Make-up Exams (Tel: 03-3238-3515) **before 17 : 00 on the day of the delay (for exams held on 5-6th class periods, before the end of the exam time)**. If the student fails to make the “tentative application” during the above period, or if a proper application is not made following the “tentative application” during specified period, he/she will not be allowed to take a make-up exam whatever the reasons may be.

- The delay will be accepted only on a student’s normal commuting route between his/her home and the university (not accepted if the route is other than from home). The address given on the “commuting route certificate seal” (zaiseki-kakunin seal) on the back of the student ID card will be checked when applying for the make-up exam.
- The delay certificate must show a delay longer than the actual length of the student’s delay. (e.g. if the student arrived 30 minutes past the scheduled exam starting time, the delay certificate must prove a delay of more than 30 minutes; application for make-up exam will not be accepted if he/she came to university assuming in the first place to arrive late to the exam.)
- Application submitted by someone other than the student himself/herself. Proxy application will not be accepted for reasons of delay in public transport service.

- ◎ **If a student arrives within 20 minutes of the scheduled exam starting time:**
If the delay is less than 20 minutes, he/she will take the exam; **go straight to the classroom** and take the exam.
- ◎ **If a student arrives more than 20 minutes after the scheduled exam:**
Bring the Delay Certificate and **go immediately to Center for Academic Affairs on 1st floor, Bldg. No.2 (Academic Services)**. Have the arrival time checked; submit the Delay Certificate and the student may apply for the Make-up Exam.
- ★ If it is difficult to decide for yourself, go first to the exam room and follow the instructions of the exam supervisor.

The schedule of make-up exam application period and points to be noted will be announced before the Final Examinations on Loyola

● Cheating in report exams is strictly prohibited

Do not be tempted to cheat or commit any other misconduct in report exams. If a student is found cheating or committing any misconduct, the University will impose severe punishment.

[Cheating in report exams involves:]

- Using sentences (block quotations) quoted from books, materials, internet website in your report without citing the sources and pretending that you wrote the sentences.
- Using reports that another student (your senior or friend) wrote for the said course or a similar course in the past and giving it off as your own report.

[Misconduct in report exams involves:]

- Writing a report for a course and using the same report to submit for another course.

If the above misconducts are found in the report exam, your class teacher will give the grade F (fail) for the course and you may be summoned and given severe warning.

Cheating or misconduct in report exams sometimes occur unintentionally and may well be avoided if a student takes more cautious stance. Read thoroughly the “Stance on Exams, Reports and Papers” to prevent misconducts and comply with the policy of “Academic Honesty”

● Stance on Exams, Reports and Papers

◆ To promote ”Academic Honesty” and to comply with its policy

As the name Sophia indicates, Sophia University respects wisdom in its ultimate form. We ask the students to cultivate an attitude of Academic Honesty based on the following two points: Sophia lays emphasis on its educational principle of respecting others and cooperating with others based on the concept of “Men and women for others, with others”.

(1) Students should respect the research and source of information of their forerunners and contemporaries and conduct independent and in-depth study.

(2) Students should make continued effort to enhance their basic academic skills.

By observing these points, students will be able to avoid committing acts of Academic dishonesty, such as breaking research rules (falsifying and fabrication of data) simply because they wished to be academically creative, or giving off research results of others as your own, or also unintentional plagiarism. All these are acts opposed to Academic Honesty

Final exams are intended for a student to check how much the student has achieved in his/her studies (written exams or reports). We expect students to be honest and sincere in the exams as they always are in class. Dishonest acts such as cheating in exams and falsifying reports shall be severely punished. We ask the students to act with respect for wisdom in various scenes with the Sophian stance of respecting wisdom.

◆ Rules for quotations in reports and papers

To evaluate your class work and give grades, teachers may ask you to hand in reports or papers. When writing the reports or papers, you will need to give your final comments and ideas on analysis results. Your ideas and comments should not be limited to self-centered views, so you must learn from the various researches conducted in the past and the present, and build your research upon these. For writing reports and papers, the following points should be noted.

- 1) If the concepts and ideas, tables and charts that a student uses in the reports and papers are taken from literature, materials or websites, he/she must give the exact places in the literature, materials or websites used.
- 2) If quoting directly from literature, materials, websites, a student must show that they are quoted by placing the phrases in quotation marks, and cite the exact source.
- 3) Needless to say, a student must write his/her own reports and papers; you must never give off reports written by friends, senior students, family members as your own

If someone you know or a total stranger gives off the essay or paper you wrote as his/her own, what would your reaction be? Citing quotation and references protects the rights of the author, and it is simply a matter of academic manners and ethics for all involved in research and studies.

If a student fail to observe the above 1), 2), and do not cite the quotation, or show where the ideas were taken from in the literature or materials, use of the written contents will be considered as data theft or plagiarism. Overseas, this “plagiarism” is strongly rebuked and even careless copying and pasting of materials from reference literature or websites are considered as plagiarism. If a student gives off papers written by another person as his/her own as stated in 3), this is an act of fraud. If you are found performing such act or data theft, you will be subject to severe punishment and warnings similar to those when found cheating in written examinations. When using quotations or reference, observe the following two important rules:

- ▼ (1) If you use quotations or references from books or websites in your report or paper, place footnotes and cite the sources. The styles of quotation citing are different in academic fields; you should ask your instructor for the details. Generally the following information should be given. When quoting from:
 - ◇ books: author, “title of book”, publisher, year of publication, pages quoted
 - ◇ papers in journals: author, ‘title of paper’, “title of journal”, Vol. ○, No.△, year of publication, pages quoted
 - ◇ website: creator, “name of site or article”, <URL http://www.○○○.△△△>
date you visited the site: year, month, day (or latest updated on-year, month, day)
- ▼ (2) In your report or paper, if you need to quote directly from materials written by someone else, put the quoted sentences in quotation marks to make it clear that the quoted sentences are not written by you.
 - ◇ Example for quoting directly in your report/paper:
“(your sentence)the author, Jochi Taro, writes on this subject “(quoted sentences) the meaning of the existence of university should be viewed from three perspectives . . .” (author: Jochi Taro, year published 20xx, page quoted p.xxx)

At senior high schools it was sufficient to simply name the reference literature, materials, or website, but at university level quotations must be cited accurately to show exactly who conducted the quoted research and what the results were on which you base your research and analysis. As shown, clear and accurate citing of quotations and references are demanded to practice Academic Honesty.

8. Evaluation / Grading

● Evaluation Criteria

Academic performance is evaluated by the class teachers according to their teaching and evaluation policy based on results of exams (written, oral, practical), reports and class attendance.

Grading and evaluation criteria are as follows:

		grade	points	QPI	criteria
evaluated	pass	A	100~90	4.0	EXCELLENT
		B	89~80	3.0	GOOD
		C	79~70	2.0	SATISFACTORY
		D	69~60	1.0	PASSING
	fail	F	59 or below	0	FAILURE (did not show results satisfying passing level in a course with passing grades of "A", "B", "C", "D")
		X	—	—	NOT PASSING (did not show results satisfying passing level in a course with passing grade of "P")
incomplete	I	—	—	INCOMPLETE (Final grade withheld temporarily)	
not evaluated	Withdrawal course	W	—	—	Withdrew from course during designated course withdrawal period
	Transfer credits approved	N	—	—	TRANSFERRED FROM OTHER UNIVERSITIES (Approved as credits equivalent to those earned at Sophia)

● G.P.A. (Grade Point Average)

The Quality Point Index (=QPI: see above list) multiplied by the number of credits for the course determines the quality points

(QP) for that course. The sum of all the quality points divided by the total number of credits attempted (excludes courses with grades W, N, P, X, I) gives the grade point average (GPA). W (withdrawn from course), N (approved course), P (passing), X (failing), I (Incomplete) are not included in the calculation.

【GPA calculation formula】

$$4.0 \times \text{credits with A} + 3.0 \times \text{credits with B} + 2.0 \times \text{credits with C} + 1.0 \times \text{credits with D}$$

The sum of all the registered courses (excludes courses with W, N, P, X, I)

● Grades Release Dates

The grades for 2012 academic year will be released as follows:

Courses	Year in school	Release period	Released via
Accumulative grades including Spring Semester	4th year	Aug 30 (Thu) ~	Loyola "Grade Review"
	3rd year	Sept 11 (Tue) ~	
	2nd year	Sep 12 (Wed) ~	
	1st year	Sep 13 (Thu) ~	
Accumulative grades including Autumn Semester	4th year	Feb 28 (Thu) ~	
	3rd year	Mar 16 (Sat) ~	
	2nd year	Mar 17 (Sun) ~	
	1st year	Mar 18 (Mon) ~	

● Request for Grade Review

If a student has any doubts about the correctness of the grade, he/she may submit a “Request for Grade Review” by the following deadline. The request form is available at Center for Academic Affairs. Any late request will not be accepted.

For the seniors, there is a separate application period set in each Semester. For the schedule check the Loyola Bulletin Board (Academic Services).

Courses	Deadline for submission
2011 One-year courses/Autumn Semester courses	March 30, 2012 (Fri) until 17:00
2012 Spring Semester courses	Sept. 27, 2012 (Thu) until 17:00
2012 One-year courses/Autumn Semester courses	March 29, 2013 (Fri) until 17:00

If you intend to submit the request, consider carefully your reasons in light of the course contents and the grading criteria of A to F; read and follow the instructions given out from Center of Academic Affairs. The following reasons will not be acceptable:

- ① you simply requesting for a re-evaluation and re-grading.
- ② Asking the teacher to be lenient (affects your prospective graduation or acquisition of teacher’s license etc.)
- ③ complains based on comparison with other students (your friend had a grade B and you don’t understand why you have a C, etc.)
- ④ you do not question the grading itself, but ask for the reason (ask the teacher for feedback, comment, disclosure of exam scores, etc.)
- ⑤ you have no specific statement such as “I have attended the classes”, “I took the exam” etc.

● Students with no prospects of academic progress

Students who are unable to earn a total of 32 credits or more in courses specified by the Departments in two consecutive years (NB) shall be dismissed from university. (Article 40 University Regulations)

(NB) This Article of University Regulations applies to all students enrolled in the present Academic Year without taking any leave of absence. If a student took leave of absence in the previous academic year, “two consecutive years” shall mean academic years prior to or after the year in which the student took leave absence and not the previous year in which the student took leave of absence.

9. Course Continuation System

● Course Continuation

Course Continuation is a system that approves the completion of a One-year course across academic years; a student may register for One-year course, take the Spring Semester course, take leave of absence or study abroad from the Autumn Semester, resume studies and take the same course in the Autumn Semester of the following academic year.

Note carefully there are some cases to which the Course Continuation system does not apply due to curriculum changes in courses offered, instructors, course subject etc. However, in general, the Course Continuation system does apply to General Foreign Language courses even if there is a change in the instructor as long as it is the same course.

● Application Procedures

- 1) Students intending to study abroad should submit “Request for Study Abroad” (留学願), those who wish to take a leave of absence should submit “Request for Leave of Absence” (休学願) by the deadlines respectively to Center for Academic Affairs (Student Registry/Certificates) and obtain permission. (If no permission is given, request for Course Continuation will be invalid)
- 2) Prior to going on study abroad or taking a leave of absence, submit “Request for Course Continuation” (継続履修願) to Center for Academic Affairs (Academic Services).
- 3) After your return to Japan or to university, register again for the course approved for Course Continuation during Course Continuation registration period (submit “Course Continuation Registration Sheet” (継続履修登録届) to Center for Academic Affairs (Academic Services)

● Requirements

- 1) The course must be a One-year course and you have already registered for the course.
 - 2) The student must have attended the course in Spring Semester.
 - 3) After attending the course in Spring Semester, you either went on a study abroad or took a leave of absence.
 - 4) Your study abroad or leave of absence continues on to the Spring Semester of the following academic year. If the study abroad or leave of absence is limited to either Spring Semester or Autumn Semester only, Course Continuation system does not apply.
For details on study abroad periods, refer to “Handbook on Study Abroad” (issued by International Liaison Office)
- ※ The schedule of distribution and submitting deadline of “Request for Course Continuation (study abroad and leave of absence)” and “Request for Course Continuation Registration” will be announced on Loyola Bulletin Board (Academic Services).
 - ※ When a student obtain permission for study abroad or leave of absence, the courses he/she has registered for the period will be cancelled.
 - ※ Course Continuation applies only to courses in two continuing academic years.

Example	April (this year)	October	March
△ In April this year, register for One-year course “A” on Loyola Submit “Request for Course Continuation” 継続履修願 to Center for Academic Affairs	Attend course “A” in Spring Semester	Leave of absence	
▲ In October of following Academic Year, <u>register for the course continuation</u> One-year course “A” (継続履修登録) (※Submit “Course Continuation Registration Sheet” (継続履修登録届) to Center for Academic Affairs)	Leave of absence	Attend course “A” in Autumn Semester	
You have completed enrollment for course “A”; you have taken course “A”			

10. Credit Transfer and Approval

● Credit Transfer and Approval

Credits earned at other universities or colleges before entering Sophia University or credits earned at overseas universities during study abroad after entering Sophia may be transferred and approved as credits equivalent to those earned at Sophia.

The requirements and maximum limit of transfer credits will vary depending on the type of credit transfer. If a student intend to have credits transferred, check the details before applying for credit transfer.

The request for credit transfer will be processed among several offices and Departments before the final decision of the approval is made and this may take about a month after application. The decision on approval of credit transfer will affect your future course enrollment plan; apply well ahead to allow sufficient time for the approval procedure.

● Grades of Courses with Transferred Credits

The credits transferred and approved will be marked “N (認定 *Nintei*)” on your transcript of records.

Except for compulsory courses, basically the courses with transferred credits will not be listed under the course titles, but will be summed up by course category (elective compulsory, elective, group xx).

The grades marked “N(認定 *Nintei*)” will not be counted into “Maximum credit limits” per semester or year at course registration; such grades will not be included in the GPA calculation.

● Transfer of Pre-matriculation Credits

Students who entered Sophia University as freshman may apply for credit transfer up to 30 credits earned at other universities, colleges, higher professional schools or Sophia School of Social Welfare prior to matriculation (must apply within 3 months after entering Sophia). For more information, inquire at Center for Academic Affairs (Academic Services)

● Credit Transfer of Transfer Students

Transfer students may apply for transfer of credits earned at other universities to be counted as equivalent to credits required for graduation at Sophia.

■ Maximum limit of credit transfer

- 1) Credit transfer will be approved in categories of General Studies (*Zengaku-Kyotsu-Kamoku*) and Specialized Education respectively up to number of credits required for graduation set by each Department.
- 2) The maximum number of credits that can be transferred will be decided by each Department up to one half of credits required for graduation set by the Department.

● Credit Transfer for Teacher Certification Program

Transfer credits approved as credits earned at Sophia University may be approved as credits for teacher certification program. If a student wish to apply for credit transfer for teacher certification program, inquire at Center for Teaching and Curator Credentials.

● Graduate School Pre-admission Course Enrollment System

Undergraduate students who show excellence in their academic performance may enroll in courses designated by each Graduate School in their senior year following a screening. On admission to Sophia University Graduate School, the credits earned in such courses will be approved as pre-admission credits up to a maximum number set by the Graduate School.

The credits earned by system of course enrollment prior to admission to Graduate School will not be approved as credits required for graduation.

The Graduate Schools/Programs that have the system of course enrollment prior to admission to Graduate School are as follows:

- Graduate School of Theology
- Graduate School of Humanities, Master's Program in French Literature
- Graduate School of Human Sciences, Master's Program in Social Services
- Graduate School of Economics
- Graduate School of Global Environmental Studies (for Autumn Semester courses only)
- Graduate School of Science and Technology

● Credit Transfer by Student Exchange Agreement

As a current student, if a student earns credits at another university in Japan affiliated by student exchange agreement, the credits will be transferred and approved as credits equivalent to those earned at Sophia.

Student exchange agreement has two types "In-country exchange type" and "Credit transfer type".

Credits earned by Sophia students at the university with exchange agreement will be approved as credits earned at Sophia, up to 30 credits for "In-country exchange type" and 10 credits for "Credit transfer type".

For more information on student exchange agreement, inquire at Center for Academic Affairs (Academic Services)

Type	Exchange University	Maximum transfer credits	Form of exchange
In-country exchange	Seisen Jogakuin College Elizabeth University of Music Nagasaki Junshin Catholic University Fuji Women's University	30 credits	Exchange students continue to be enrolled at Sophia University (student status at Sophia will be "study abroad"); during exchange period, students will take courses and engage in research at the host university.
Credit transfer	Tokyo Junshin Women's College Tokyo College of Music	10 credits	Students will be enrolled at Sophia and take courses at Sophia and at the same time take courses and engage in research at the host university.

● Credit Transfer from Study Abroad

As a current student, if you earn credits on student exchange program (study abroad at an overseas university under student exchange agreement with Sophia) or on general study abroad (at a degree-awarding university approved by Department Chair prior to the study), the credits will be transferred up to 30 credits and approved as credits equivalent to those earned at Sophia (must apply within 3 months after return to Japan). For more information, refer to “Handbook on Study Abroad” (issued by International Liaison Office)

■ Calculation of credit transfer

(1) Most universities including US

One class hours (in minutes) × number of classes in a week × course duration (number of weeks) ÷ basic class hours at Sophia

(2) Universities in Spain, Brazil etc.

Total class hours in a year × 60 (in minutes) ÷ basic class hours at Sophia

Basic class hours at Sophia

Type of courses	Basic class hours
Lectures/seminars	675 min (1 unit)
Languages/seminars	1350 min (1 unit)
Experiments	2025 min (1 unit)
Physical exercise	1350min (1 unit)

* Note that for credit transfer, you must have the class schedule which is the basis for calculation.

■ Office hours for credit transfer application

Depending on submission period of credit transfer application, the approved credits may be included in either “Spring Semester” or “Autumn Semester” and will be marked “N 認定Nintai”

March 5 (Mon) – August 31 (Fri), 2012/application submitted to Center for Academic Affairs

→approved as credits for “2012 Spring Semester

September 3, 2012 (Mon) – March 1 (Fri), 2013/Application submitted to Center for Academic Affairs

→approved as credits for “2012 Autumn Semester

※ Approved credits “N” will not be counted into maximum credit limit per year. It will not be included in calculation of GPA.

For more information, refer to “Handbook for Study Abroad” issued by International Liaison Office.

11. Overseas short-term language program/ overseas short-term Study Abroad programs

● Credit Transfer from Overseas Short-term Language Program

This program is intended for students to participate in language programs at affiliated universities overseas during university vacations and to transfer credits successfully earned and have them approved as foreign language credits (2 credits). Note however that students who wish to transfer the credits earned in the program to the last semester before expected graduation, are eligible to participate in the program but credit transfer will not be possible.

The grades for the language courses will be either “P (pass)” or “X (fail)”.

Courses with grades “P” or “X” will not be included in the maximum credit limit per semester or year at course registration and will not be included in calculation of GPA.

For more information on language programs, refer to “Foreign Language Courses” (履修要覧共通編 p.174～) and “Handbook on Study Abroad” issued by International Liaison Office.

● Credit Transfer from Overseas Short-term Study Abroad Training Programs

The program are intended for students to participate in the programs at affiliated universities abroad during university vacations and to transfer credits successfully earned and have them approved as credits of Sophia. Note however that students who wish to transfer the credits earned in the program to the last semester before expected graduation, are eligible to participate in the program but credit transfer will not be possible.

Participating students should have a certain level of language proficiency to study their major subjects taught in a foreign language.

Overseas Short-term Study Abroad programs have two types of programs and transferred credits will be marked differently.

- 1) Credits earned at the university offering the transfer approved program are transferred and approved.
→ Grades will be shown as “N Nintei” (認定)
- 2) Courses registered as courses offered at Sophia;
→ Grades will be shown as “P (pass)” or “X (fail)”.

Courses with grades “P”, “X” or “N” will not be included in the maximum credit limit per semester or year at course registration and will not be included in the calculation of GPA.

For more information on overseas short-term training program, see the list on p.38.

<List of Overseas Short-Term Study Abroad Programs>

※ The following programs may be changed or cancelled without notice; check the updated information at International Liaison Office.

(1) Credits transferrable to be approved as credits earned at Sophia

University	Language of instruction	Country	Program duration	Credits	Grades and credits
University of California, Los Angeles (UCLA)	English	USA	During summer vacation	Depends on courses taken by the participant	<ul style="list-style-type: none"> * may be approved as General Studies (<i>Zengaku Kyotsu Kamoku</i>) (Electives) or Specialized Education; will not be approved as language courses * participant should consult the Department Chair before going abroad, and he/she will need to submit request for credit transfer on return to Japan. * may be approved as credits for 2012 Autumn Semester; the grade given to successful participant will be “N” transfer approved (Nintei).
Ecole Supérieure des Sciences Commerciales d'Angers	English	Hungary	During Spring vacation	Depends on courses taken by the participant	<ul style="list-style-type: none"> * may be approved as General Studies (<i>Zengaku Kyotsu Kamoku</i>) (Electives) or Specialized Education; will not be approved as language courses * participant should consult the Department Chair before going abroad, and he/she will need to submit request for credit transfer on return to Japan. * may be approved as credits for 2013 Spring Semester; the grade given to successful participant will be “N” transfer approved (Nintei). * The program is based on exchange agreement; the tuition is waived. (participants are responsible to pay their air fare, accommodation and meals). If students of Faculty of Liberal Arts participate and obtain credits that are approved, they will pay the tuition equivalent to the transferred credits.

2) Courses taken may be considered equivalent to courses offered at Sophia

University	Language of instruction	Country	Program duration	Credits	Grades/credits	Faculty/Dept. offering course
Université de Franche-Comté	French	France	During summer vacation	4	<ul style="list-style-type: none"> * For students of Department of French Literature, Faculty of Humanities, Department of French Studies, Faculty of Foreign Studies only. * may be counted as 4 credits of French, major foreign language * credits will be given in 2012 Spring Semester and successful participants will receive grade P. 	Dept. of French Studies, Faculty of Foreign Studies
Universität Trier	German	Germany	During summer vacation	2	<ul style="list-style-type: none"> * For students of Department of German Studies, Faculty of Foreign Studies only. * may be counted as Elective course “German III” of Department of German Studies, Faculty of Foreign Studies. * credits will be given in 2012 Spring Semester and successful participants will receive grade P. 	Dept. of German Studies, Faculty of Foreign Studies
University of Cambridge, Lucy Cavendish College	English	United Kingdom	During summer vacation	4	<ul style="list-style-type: none"> * may be counted as Zengaku Kyotsu General Studies (Electives) or Specialized Education course; will not be approved as language courses. * credits will be given in 2012 Spring Semester and successful participants will receive grade P. 	Dept. of English Studies, Faculty of Foreign Studies
Institut d'Etudes Politiques de Paris	English	France	During Spring vacation	4	<ul style="list-style-type: none"> * may be counted as Zengaku Kyotsu General Studies (Electives) or Specialized Education course; will not be approved as language courses. * credits will be given in 2012 Spring Semester and successful participants will receive grade P. 	Dept. of French Studies, Faculty of Foreign Studies
Santa Clara University	English	USA	During summer vacation	2	<ul style="list-style-type: none"> * may be counted as elective Course of Science and Technology Shared Course Group I; will not be approved as credits required for graduation.. * credits will be given in 2012 Spring Semester and successful participants will receive grade P. 	Faculty of Science and Technology Common Programs
University of North Carolina at Charlotte	English	USA	During Spring vacation	2	<ul style="list-style-type: none"> * may be counted as elective Course of Science and Technology Common Programs Group I; will not be approved as credits required for graduation.. * credits will be given in 2012 Spring Semester and successful participants will receive grade P. 	

Academic Records

1. Academic Records

... P. 40

Student ID No. / Student ID Card / Period of enrollment /
Repeating year of studies/ leave of absence / Resuming studies /
Suspension from university/ Withdrawal and Dismissal/ other cases

2. Certificates

... P. 44

Certificates issued by Automatic Certificate Issuance Machine
Certificates issued by application at office

3. Study Abroad

... P. 46

Application / Course continuation / Transfer of credits

4. Change of Faculty/Department/Re-entry/Second degree admission

... P. 47

Change of Faculty /Department
Re-entry/Second degree admission

5. September Graduation / Early Graduation

... P. 48

September Graduation / Early Graduation

1. Academic Records

● Student ID Number

All students are given an individual Student ID Number on entering the University. The Student ID Number is necessary in all scenes of student life; memorize your Student ID Number.

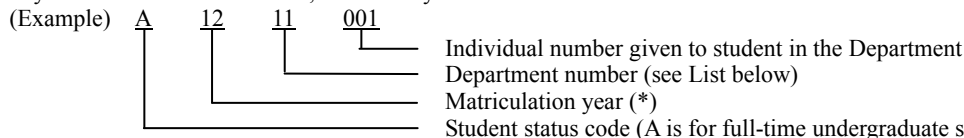

* Transfer, Second degree admission, Re-entry students are given ID numbers of the relevant matriculation year and this may be different from the actual year of entrance.

■ List of Department Numbers

Faculty	Department	Dept. No
Theology	Theology	91
Humanities	Philosophy	11
	History	14
	Japanese Literature	15
	English Literature	16
	German Literature	17
	French Literature	18
	Journalism	19
Human Sciences	Education	81
	Psychology	82
	Sociology	83
	Social Welfare	84
	Nursing	85
Law	Law	31
	International Legal Studies	32
	Legal Studies of the Global Environment	33
Economics	Economics	41
	Management	42

Faculty	Department	Dept. No
Foreign Studies	English Studies	51
	German Studies	52
	French Studies	53
	Hispanic Studies	54
	Russian Studies	55
	Luso-Brazilian Studies	56
Liberal Arts	Liberal Arts	67・68(※)
Science and Technology	Materials & Life Science	76
	Engineering & Applied Science	77
	Information & Communication Science	78
	Mechanical Engineering	71
	Electric & Electronic Engineering	72
	Mathematics	73
	Physics	74
	Chemistry	75

※Students enroll in Spring: 67

※Students enroll in Autumn: 68

● Student ID Card

The Student ID Card certifies that you are a student of Sophia University. **Carry it with you at all times** as you may be asked to show it in various situations both on and off campus. Note carefully in the following cases; services may not be provided if you do not have your Student ID Card.

Student ID Cards **should not be lent or given to another person** whatever the reasons may be. Return the Student ID card to the university when you lose your student status by withdrawal from university etc.

■ You will need the Student ID Card in the following cases:

- 1) to take the exams
- 2) to use the certificate issuance machine and obtain a certificate or student travel fare discount certificate
- 3) to enter the university main library, to borrow library books
- 4) to buy your commuting pass
- 5) to show at the request of officials when you are on trains etc. using commuting pass or student discount ticket
- 6) to see a doctor at affiliated clinics contracted with Sophia University Student Health Insurance Mutual Union
- 7) to show when requested by a faculty or staff of Sophia University

■ Valid Enrollment Sticker

Student ID Card is valid only with a current Enrollment Sticker (Zaiseki – kakunin Seal) affixed on the back. The Sticker is valid for one year; **change to a valid current sticker at the beginning of each academic year**. Notify Center for Academic Affairs, Academic Records Section if there are any changes in your address and commuting route or when there is no vacant column left in the commuting pass issue record.

■ Changes in the data of Student ID Card

If there are any changes or errors in the data (name, date of birth etc) on the Student ID Card, notify Center for Academic Affairs, Academic Records Section

■ Lost, damaged or broken Student ID Card

Request for a re-issue at Center for Academic Affairs, Academic Records Section; purchase fee payment sticker (800yen) and place it on the designated form of “**Request for re-issue of Student ID Card**” (学生証再発行願).

● Period of enrollment

Permitted period of enrollment at Sophia University is 8 years. Period of leave of absence will not be counted in period of enrollment (Article 38, University Regulations). The required period to complete study courses (residence requirement) at Sophia University is 4 years except in cases of early graduation. The periods of leave of absence, suspension from university, or study abroad exceeding one year are not counted in the residence requirement (Article 13, Article 57-2, University Regulations)

● Repeating a year

A student who fails to complete the graduation requirements in the four years of study after entering university will have to repeat a year.

When a student needs to repeat a year, a Student ID Card with extended period of validity will be sent by postal mail to the student at the end of March. If the remaining credits required for graduation is 12 credits or less, there will be a reduction of the tuition and fees automatically. For more details, inquire at Center for Academic Affairs (Academic Records Section: Tuition and Fees).

● Leave of absence

A student who wishes to take a leave of absence due to reasons beyond control such as illness must consult the Department Chairperson or class teacher and submit the completed form of “Request for leave of absence” (休学願 designated form); if the reason is illness, it must be accompanied by a supporting doctor’s certificate.

The period of leave of absence is not counted in the residence requirement and graduation will be delayed for the duration of absence.

■ Period of Leave of Absence

Leave of Absence may be requested **per semester** (Spring/Autumn semester). Leave of Absence may not extend over two continued years or a total of 4 years. (Article 32 University Regulations).

■ Deadline to submit request

	Period of Leave of absence	Deadline to submit request
Spring Semester	April 1 – Sept. 20	May 31 (Thu)
Autumn Semester	Sept. 21 – March 31	Nov. 30 (Fri)

A student who intends to take a planned leave of absence must submit the “Request for Leave of Absence” latest one month prior to the beginning of the academic year or semester of the planned absence.

Any request submitted after the deadline will not be accepted for whatever reasons. If the request is sent by postal mail, it must be postmarked on or before the deadline date. The request for leave of absence may be submitted for two consecutive years of absence.

■ Course Continuation

Course Continuation (継続履修) is a system that approves the completion of a One-year course across academic years; a student may register for One-year course, take the Spring Semester course, take leave of absence in the Autumn Semester, resume studies and take the same course in the Autumn Semester of the following academic year. For details of requirements and procedures, refer to p.38 “9. System of Course Continuation”

■ Tuition and fees

There will be a reduction of the tuition and fees during leave of absence. For more details, inquire at Center for Academic Affairs (Academic Records Section: Tuition and Fees).

● Resuming studies

When the period for Leave of Absence is over, student status returns automatically to resume studies, so there is no need to submit an **“Intent to resume studies” form** (復学届). However, in the following cases, it is necessary to submit the “Intent to resume studies” form.

- 1) leave of absence due to illness (attach supporting **doctor’s certificate** 医師の診断書)
- 2) a student wishes to return to studies earlier than scheduled; permission for leave of absence is obtained for 2 or more semesters but student wishes to shorten the period of absence as the reason for taking the leave no longer exists (the period may not be shortened to less than one semester)

● Suspension from university

A student who commits violations such as misconduct in examination shall be given severe penalties including suspension or withdrawal from university according to Article 60 of University Regulations. The period of suspension is not counted in the residence requirement and such student will not be able to graduate from university in four years, the normal residence requirement. Student will be able to return to university studies on the day following when the indefinite suspension is lifted or when the term of the definite suspension expires.

● Withdrawal and Dismissal

There are two types of withdrawal from university; voluntary withdrawal and involuntary withdrawal dismissal.

■ Voluntary withdrawal

A student wishing to withdraw from university for certain reasons must consult the Department Chairperson or class teacher, complete the “Request to withdraw from university” (退学願) and submit it to Center for Academic Affairs (Academic Records Section) **with the Student ID Card**.

Students who intend to withdraw from university must have paid all tuition and fees for the period prior to the withdrawal.

If a student submits “Request to withdraw from university” before the end of the Spring Semester and the approved withdrawal date is before the end of the Spring Semester, there will be a reduction of the tuition and fees. For more details, inquire at Center for Academic Affairs (Academic Records Section: Tuition and Fees).

■ Dismissal from the university

The following students shall be dismissed from the university:

- 1) Expiry of Period of Enrollment
Students whose period of enrollment (excluding leave of absence period) exceeds 8 years.
- 2) Students to whom Article 40 of University Regulations applies
Students who fail to obtain 32 credits or more including subjects specified by undergraduate departments in two consecutive academic years.
- 3) Failure to pay tuition and fees
Students who fail to pay the tuition and fees before the set deadline.
- 4) Other reasons
Students to whom Article 60 and 61 of University Regulations apply.

● Other cases

If there are any changes in the following, submit a notification to Center for Academic Affairs (Academic Records Section)

■ **Changes in the name or other data of student**

If there are any changes in the name, address, telephone number of the student, submit a notification by designated form available at the office. If there are changes in the name of the student, attach a certificate of residence (住民票の写し) issued by the local government (stating the full name, gender, date of birth of the student; permanent address, family relation are not required). A student of non-Japanese nationality needs a photocopy of a Resident Card (在留カード).

■ **Changes in guarantor etc.**

If a student intends to change his/her guarantor, or there are any changes in the registered address, telephone number of the guarantor, submit a notification by designated form available at the office.

■ **Extension of period of stay**

If a student of non-Japanese nationality renews period of stay or changes the visa status, submit a photocopy of "Resident card" to the center for Academic Affairs (Academic Records Section). Failure to submit the above copies of certificates may cause great inconvenience such as permission to use Loyola ID is denied, limited services in receiving scholarship grants, or any other matter while you are enrolled.

2. Certificates

Various certificates are issued either from the certificate issuance machine or at relevant offices. **Check the type of certificates** you need and apply as follows:

● Certificates issued from the certificate issuance machine (NB 1)

Certificates	Fees	Day of issue	Notes
Certificate of Attendance (Japanese / English)	¥100	On the same day	Issuance machines are installed on: ・ 3rd floor, Bldg. No.2; ・ Mejiro Seibo Campus (in office center) Service Hours: Mon. - Fri. 9:00 to 17:00 * any changes due to school events will be announced
Official Transcript (Japanese / English)	¥200		
Certificate of prospective graduation (Japanese / English) (NB2)	¥100		
Student Discount Certificate	free		
Medical Checkup Certificate (university designated form in Japanese only)	¥300		
Temporary Student ID Card (issued only during Final Exam period)	¥500		

Please follow the voice instructions of the certificate issuance machine on how to operate the machine.

- (NB1) Student ID Card is required to have the certificate issued. The certificate issuance machine is available for current students only.
- (NB2) The Certificate of Prospective Graduation certifies that the student has met all graduation requirements and is eligible to graduate, but it does not mean that the University guarantees the student's graduation.
- (NB3) For the password, inquire at Center for Academic Affairs (Academic Records Section).

● Certificates issued at the office

Certificates	Fees	Day of issue
Certificate of prospective acquisition of teacher's license	¥400	Takes 3 working days from day of application
Graduation / Degree Certificate (Japanese / English)	¥300	Application received → Day of issue ・ Mon/Tue → Fri ・ Wed/Thu → following Mon ・ Fri → following Wed
Certificates necessary for application of "Permission to change the status of residence" and "Permission to extend period of stay"	¥100	
Official Personal Report	¥500	(NB4)
Re-issue of Student ID Card	¥800	On the same day

Office in charge: Center for Academic Affairs (Student Registry/Certificates); 1F, Bldg. No.2

Office hours: Mon. thru Fri. 9:30 - 11:30, 12:30 - 17:00

* Any changes due to school events will be announced on Loyola.

- 1) Complete application forms available at the office.
- 2) Purchase fee payment sticker from the vending machine and place it on the application form.
- 3) Submit application form with your Student ID Card to the office. Receipts will be issued to the applicant.
- 4) On the day of issue, show the Receipt at the office and receive the certificates.

(NB 4) Official Personal Reports

The personal report is necessary to apply for entrance to other post-graduate schools, and normally each school has its own designated form. The report is different from other certificates in that each statement section is filled out by different person or office in charge. Basic form of personal reports is as follows, however, the procedures for issuing and days required may vary according to the different forms of the report; please inquire at the office.

Statement Section	Person making the statement	Notes
Personal information (full name, date of birth etc.)	Student himself/herself	
Academic observation/ information on student while at school	Instructor (seminar, thesis mentor)	Student is responsible to ask instructors to fill out the form
Physical findings	Health Center	Only for students who had annual medical check ups at university
Official transcript	Center for Academic Affairs (Academic Records Section)	Center for Academic Affairs will attach the official transcript to the form
University certification	Center for Academic Affairs (Academic Records Section)	Presidential stamp will be placed and date filled out

3. Study Abroad

Depending on the types and period of study abroad, there are differences in the tuition, application papers, inclusion to the residence requirement, and transfer of credits. Students who wish to study abroad should read thoroughly the “Handbook for Study Abroad” issued by International Liaison Office, plan their study well and then apply.

● Application

For application of general study abroad, submit “Request for Study Abroad” (留学願) to Center for Academic Affairs (Academic Records Section).

For application of exchange study abroad, follow instructions of International Liaison Office.

When you return from a study abroad, submit promptly the “Report of Return to Japan” (帰国届) to Center for Academic Affairs (Academic Records Section)

● Course Continuation

Course Continuation (継続履修) is a system that approves a student to complete a One-year course across academic years; the student takes a course in Spring Semester, goes on study abroad, returns and takes the same course in Autumn Semester of the following academic year to complete it. Course Continuation is approved only when necessary procedures are followed. (For more information, please refer to p.33 “9. System of Course Continuation”

● Transfer of Credits

The credits earned during study abroad can be transferred to credits earned at the University up to 30 credits (credits earned during overseas study by taking leave of absence do not apply here). For more details, please refer to p.34 “10. Transfer and recognition of credits” and the “Handbook of Study Abroad” issued by International Liaison Office.

4. Change of Faculty·Department/ Re-entry/ Second Degree Admission

● Change of Faculty·Department

Students who wish to change to another Department of the Faculty he/she is currently enrolled in or to a Department of another Faculty and who satisfy the following requirements may do so by submitting a request. After submitting the request, the student will take an exam given by each Department.

■ Eligibility

- 1) Student has completed or is expected to complete at least two years of study at the time of the requested change (period of leave of absence is not included)
- 2) Student has a 2.66 GPA or higher for credits obtained in University-wide General Studies (Zengaku kyotsu).
- 3) Student satisfies all requirements set by the Department he/she wishes to change to.
- 4) There is adequate cause for the change.

● Re-entry

Re-entry is admission of students who have withdrawn from Sophia University and wish to enter again the Faculty/Department he/she has been previously enrolled in.

■ Eligibility

Student must fall under one of the following:

- 1) Withdrawal under Article 39 ,University Regulations (Voluntary withdrawal; withdrew on or before September 20, 2012)
- 2) Withdrawal under Article 64, University Regulations (failure to pay tuition and fees; withdrew on or before September 20, 2012)
- 3) Withdrawal under Article 40, University Regulations (32-credit system; withdrew on or before March 31, 2012)
- 4) Withdrawal under Article 60, University Regulations (violation of Regulations; withdrew on or before March 31, 2012)
- 5) Withdrawal under Article 61, University Regulations (violation of Four articles of inappropriate enrollment; withdrew on or before March 31, 2012)

The following students cannot apply for re-entry:

- 1) Withdrawal under Article 38; period of enrollment exceeded the permitted number of years (8 years).
- 2) Students who withdrew again after re-entering university.

■ Application period

Early to mid- January 2013

● Second degree admission

Second Degree Admission is admission of students who have graduated (or are expected to graduate) from Sophia University and who wish to enter another Department of the Faculty he/she graduated/will graduate from or a Department of another Faculty for their second Bachelor degree. When application is submitted, each Department will hold its own examination.

Please note that the Departments students may apply for depend on the Department's space availability and may vary by academic year.

For more information, inquire at Center for Academic Affairs (Academic Records Section).

※ The guidelines for Change of Faculty·/Department, Re-entry, Second Degree Admission will be given out from December 2012.

For more details, inquire at Center for Academic Affairs (Academic Records Section).

5. September Graduation/ Early Graduation

● September Graduation

Students who have satisfied the graduation requirements are eligible for September Graduation, however, September Graduation is not applied automatically to students who have satisfied the graduation requirements. Students who wish to graduate in September 2012 must apply by submitting designated form to Center for Academic Affairs (Academic Services) **by July 23 (Mon), 2012**. For more details, please check Loyola Bulletin Board (Academic Services), There will be a reduction of tuition and fees. For more details, inquire at Center for Academic Affairs (Academic Records Section: Tuition and Fees).

● Early Graduation

The basic residence requirement of Sophia University is 4 years. However, students (1) who are enrolled at Sophia for 3 years or more, (2) have completed the required courses for graduation with good academic performance and (3) who wish to graduate early, may request for approval of early graduation upon discussions of the Faculty Meeting of the relevant Faculty. The Faculties that approve Early Graduation at present are as follows:

1) **Faculty of Liberal Arts**

For more information, please refer to “Bulletin of Information” of Faculty of Liberal Arts.

2) **Faculty of Law**

For more information, please refer to the pages of each Department.

3) **Faculty of Economics**

For more information, please refer to the pages of each Department.

4) **Faculty of Science and Technology**

For more information, please refer to the pages of Handbook of Course Registration (for Departments) “To students of the Faculty of Science and Technology (matriculated in 2008 or later)”

■ **Tuition and Fees**

1) Tuition and fees are not charged for the academic year the student is not enrolled in.

2) If the student graduates in three and half years, there will be a reduction of tuition and fees (except for Faculty of Liberal Arts).

For more information, inquire at Center for Academic Affairs (Academic Records Section: Tuition and Fees)

General Studies

Studies in Christian Humanism

… P. 50

Language (Academic Skills)

… P. 51

Health and Physical Education

… P. 51

General Studies Elective Courses

… P. 51

GENERAL STUDIES

Studies in Christian Humanism

Two courses in the category “Studies in Christian Humanism” (キリスト教人間学) for a total of 4 credits are compulsory for all students who are enrolled in the Faculty of Science and Technology. Normally, students must take one course in their first semester and another the second semester.

offered in the autumn semester (2012)

Origins and Developments of Human Dignity	2cr
Philosophy of the Human Person	2cr
Philosophy of Human Violence	2cr
Philosophy of Human Nature	2cr

offered in the spring semester (2013)

Philosophy of the Human Person	2cr
Philosophy of Human Rights and Human Dignity	2cr
Philosophy of Human Violence	2cr
Philosophy of Human Nature	2cr

Please note that places in these courses will be chosen by lottery, and so students should register for these courses during the **pre-registration period**. For details, See page 20～.

Language (Academic Skills)

■ Course details

The objective of Academic Skills courses is to prepare students to study the academic subjects required in their fields of specialization. They comprise study skills, including critical thinking, presentation, and discussion skills, as well as academic writing and organization skills.

■ Registration Rules

- Academic Skills must be taken in the following sequence:

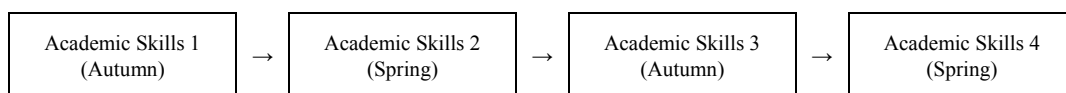

- * Students cannot register for the next course if they have not passed the previous course. (If students have not passed AS1, they cannot register for AS2. They have to re-register for AS1 in the following Autumn semester.)
- * Students cannot register the same course which they have already passed.
- Students must take all courses and complete 8 credits. (2 credits / course)
- Academic Skills are counted as Compulsory Language (General Studies).
- No withdrawals are allowed for these courses.
- Students should register for these courses during the registration period.
- 85% attendance is strictly required.

Health and Physical Education

“Wellness, the Body and Culture” (ウエルネスと身体), 2 credits, is compulsory for all students. This course should be taken in autumn semester. The course will be offered in English. Students will be assigned to the appropriate class. An adapted course for students with disabilities will also be offered every autumn semester (see the page 履修要覧共通編 p.75). Withdrawal is not allowed from H.P.E. courses.

General Studies Elective Courses

Students may take courses for 16 credits from programs offered by Faculty of Liberal Arts. They must choose the courses either from category of the Legacy of the Past, the Cultural Traditions, the Contemporary World, of the elective courses of General Studies or Japanese Language Program. Note that only up to 8 credits are approved for courses from Japanese Language Program. Students may also take any courses listed in the university-wide General Studies program as Zengaku kyotsu kamoku (全学共通科目) (cf.履修要覧共通編p.84~)

■ Categories and List of Courses

<The Legacy of the Past> The courses in this category introduce students to the experiences of different human societies, from ancient times to more recent periods. They look at the development of institutional, intellectual, and social patterns that continue to influence our ways of thinking and acting today.

HST201, 202	History of Western Civilization 1, 2
HST251, 252	Development of Japanese Civilization 1, 2
HST261, 262	History of Chinese Civilization 1, 2

<Cultural Traditions> From the very beginning humans have sought to communicate their ideas about themselves, their societies, and the world. The courses in this category introduce written and artistic expressions of human creativity. They provide students with experience in the analysis and interpretation of particular literary texts, philosophic concepts, works of art, systems of belief, and symbolic structures.

ART201	Introduction to Art History
ART230	Introduction to Asian Art
ART250	Introduction to Japanese Art
LIT201	Literary Genres
LIT202	Introduction to the Performing Arts
LIT231	Introduction to Japanese Literature
RPH201	Introduction to Philosophy
RPH202	Fundamentals of Religion
RPH203	Religion, Culture, and Society

<The Contemporary World> Social, political, and economic factors play a major role in shaping the world in which we live. The courses in this category introduce students to some of the major approaches for investigating the nature and impact of such factors.

ANT202	Cultural and Social Anthropology
ANT220	Anthropology of Japan
ANT230	Culture and Identity
IBE200	Principles of Microeconomics
IBE201	Principles of Macroeconomics
POL201	Theories and Themes of Contemporary Politics
POL205	Introduction to International Relations
POL210	Introduction to Comparative Politics
SOC201	Introduction to Sociology
SOC222	Introduction to Contemporary Chinese Society
SOC223	Globalization and Society

<Others>

COM211	Computer Studies 1*
COM212	Computer Studies 2*
COM213	Computer Studies 3*
COM214	Computer Studies 4*
ENV131	Environmental Issues 1
GEO201	Human Geography
GEO202	Geography
LNG210	Introduction to Linguistics
MTH101	College Mathematics
MTH111	Mathematics and Statistics for Business and Economics

*N.B. These courses carry 2 credits each.

<Japanese Language Program>

The Faculty of Liberal Arts (FLA) and the Center for Language Education and Research offer various levels of Japanese language courses. Students who need to use Japanese in daily life or wish to employ Japanese language proficiency in a workplace after graduation are encouraged to take Japanese language courses. The type of course a student initially enrolls in will depend on his/her linguistic background. The background is divided into two major categories as follows:

1. Non-native speakers of Japanese

If students have no knowledge of Japanese, they should enroll in JPN111 (Japanese 1). If they have some prior exposure to Japanese, they should take the Japanese Placement Test; they will be placed in the appropriate class

level on the basis of their performance on the test and consultation, if necessary, with the Japanese language faculty.

2. Native speakers of Japanese

a) “Graduate of Japanese high school”

This category indicates (a) a student who has received a diploma from public or private high school that teaches in Japanese; (b) a student who, regardless of whether he or she has received a diploma from such a school, has spent at least four out of the six years of junior high school and high school in a public or private school that teaches in Japanese. They are encouraged to take JPN 350 (College Skills), JPN351 (Composition) and more specialized courses, if they wish to acquire college-level literacy skills. Students in this category do not need to take the Japanese Placement Test.

b) Native and near-native speakers with substantial background in Japanese who are not “graduates of Japanese high schools”

Students in this category, including those who are graduates of international schools in Japan or the special international programs offered by some Japanese schools, are encouraged to take Japanese in order to use Japanese in a workplace in the near future. They should take the Japanese Placement Test to determine their Japanese-language level. The courses available for those in this category, which focus on literacy development, are JPN341, 342, 343 (Reading & Writing), JPN350 (College Skills), and more specialized courses.

■ Information on Japanese Language Curriculum

COURSE NUMBERS

100-level courses: Beginning courses

200-level courses: Intermediate courses

300-level courses: Advanced courses

400-level courses: More specialized courses

Prerequisites: Check the course description before registering for a course. If a prerequisite course number is listed, it means that students should finish that course first. If “instructor’s permission” is listed as an alternative to a prerequisite, the student must talk to the instructor before registering for the course.

■ Japanese Language Tracks

The following diagrams summarize the different Japanese language tracks offered by FLA / the Center for Language Education and Research.

Note: JPN111→JPN112 etc. denotes the normal route.

Track 1: Japanese Courses for Non-Native Speakers

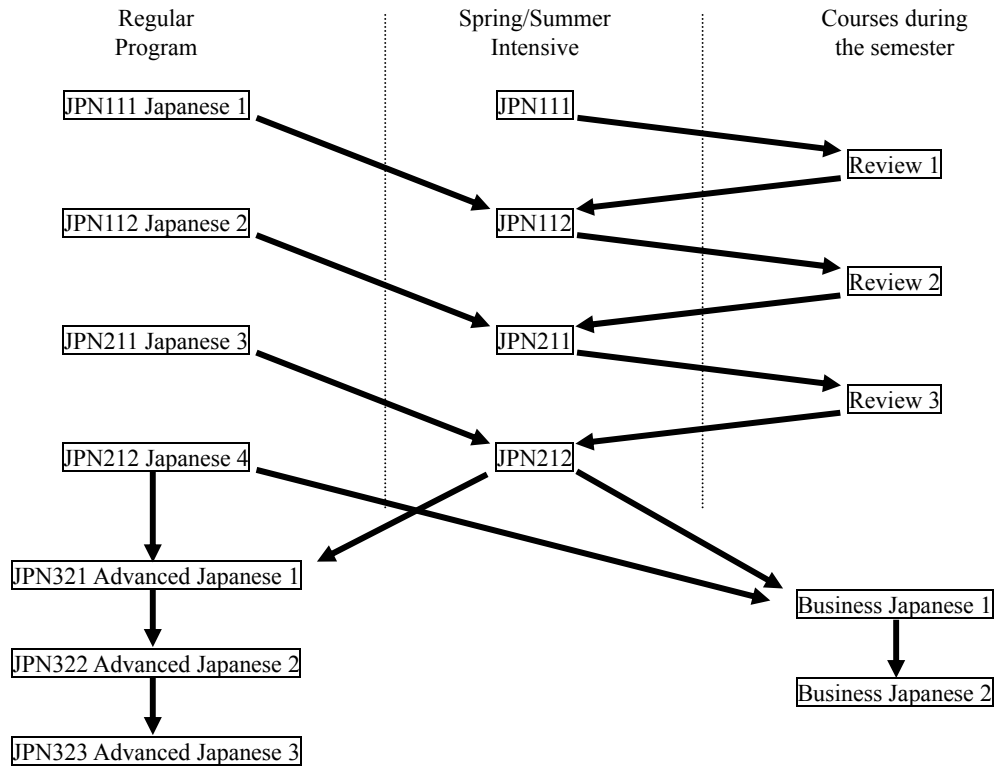

* FST Students who take the Japanese Intensive Courses during the break should take the review courses during the semester to maintain Japanese proficiency.

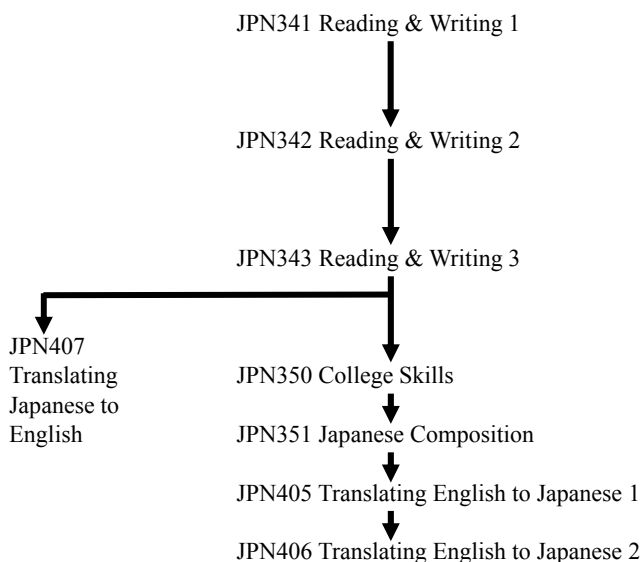
Track 2: Japanese Reading and Writing Courses (Primarily for Native or Near-Native Speakers to Develop Literacy) and Specialized Japanese Courses

■ Class Hours of Japanese Language Courses

Course No.	Title	cr	Hours
JPN 111	Japanese 1	4	} Five 90-minute classes a week
JPN 112	Japanese 2	4	
JPN 211	Japanese 3	4	
JPN 212	Japanese 4	4	} Four 90-minute classes a week
JPN 321	Advanced Japanese 1	4	
JPN 322	Advanced Japanese 2	4	
JPN 323	Advanced Japanese 3	2	} Two 90-minute classes a week (Scheduled to be offered in 2013)
Undecided	Business Japanese 1	2	
Undecided	Business Japanese 2	2	

Course No.	Title	cr	Hours
JPN 341	Reading & Writing 1	2	} Two 90-minute classes a week
JPN 342	Reading & Writing 2	2	
JPN 343	Reading & Writing 3	2	
JPN 350	College Skills	4	
JPN 351	Japanese Composition	4	
JPN 405	Translating English to Japanese: Theory and Practice 1	4	
JPN 406	Translating English to Japanese: Theory and Practice 2	4	
JPN 407	Translating Japanese to English: Theory and Practice	4	

Spring/Summer Intensive Program

Course No.	Title	cr	Hours
JPN 111	Japanese 1	4	} twelve 90-minute classes a week
JPN 112	Japanese 2	4	
JPN 211	Japanese 3	4	} seventy-two 90-minute classes in Feb. to March in total
JPN 212	Japanese 4	4	
			} ten 90-minute classes a week
			} fifty-eight 90-minute classes in Feb. to March in total

Faculty of Science and Technology Curriculum

For all English Course Students

… P. 58

Bachelor's Program in Green Science

… P. 61

Bachelor's Program in Green Engineering

… P. 64

Course List

… P. 69

Faculty of Science and Technology Curriculum

For all English Course Students

1. Organization of the Faculty of Science and Technology

The Faculty of Science and Technology provides students with “cross disciplinary knowledge” that integrates “science” and “technology”. With the motto, “human and environmental support,” the department seeks to produce graduates who are able to take active steps toward realizing human societies that are in harmony with nature. These students must also have the capability of adapting to the knowledge-based society. To do so, the faculty consists of the following three departments:

1. Department of Materials and Life Sciences
2. Department of Engineering and Applied Sciences
3. Department of Information and Communication Sciences

Each department provides a variety of unique educational programs; the Department of Materials and Life Sciences teaches students “new and innovative ways to view materials that are in harmony with nature”, the Department of Engineering and Applied Sciences teaches students “to create materials and devices that will greatly benefit both global and human environments”. and the Department of Information and Communication Sciences provides students “an in-depth understanding of human and society through information”.

To meet the needs of internationalization, the faculty has established courses taught in English as part of its regular curriculum since September 2012. There are 15 places available for the Department of Materials and Life Sciences English Course (Green Science Course) and the Department of Engineering and Applied Sciences English Course (Green Engineering Course) have capacities for 15 students each. The students enrolled in the English courses will complete all classes, examinations, reports, research guidance, and graduation thesis in English. Thus, all courses provided to these English program students shall be given in English until graduation.

In this faculty, classes are divided into General Studies (Zengaku Kyotsu Kamoku) and Specialized Education (Gakka Kamoku). Students must take classes that satisfy all of the requirements for their particular programs. However, since the university is a place where students gain academic knowledge by studying, it is important for students to play an active role in planning the content of their own study programs and take full responsibility for their own learning.

2. General Studies (Zengaku Kyotsu Kamoku)

General Studies (Zengaku Kyotsu Kamoku) differ from Specialized Education (Gakka Kamoku) in that they aim to bestow students with the ability to gain knowledge from a wide range of perspectives. In order to do so, students are expected to take subjects in humanities, social sciences, and natural sciences. Particularly, in today’s world in which industrial technology has such a widespread and important influence over the lives of human beings, it is important for students studying in the Faculty of Science and Technology to gain a solid understanding and ability to make sound judgments with respect to human society, and the environments surrounding us. Such knowledge will help them utilize their expertise in fulfilling their social responsibilities in the future. Therefore, we hope that students will take an open-minded approach when enrolling in General Studies (Zengaku Kyotsu Kamoku) so that their overall learning experience will be both positive and meaningful.

1) Foreign Languages

For students studying science and technology at the university level, there is an increasing need to acquire the ability to read textbooks and other documents as well as to present the results of their research in foreign languages. Furthermore, once they graduate, foreign languages will play an even more important part in their lives, no matter what career path they choose to specialize in. This stems from the international

nature of science and technology, and the tendency will increase in the future. However, foreign languages are not only important for practical reasons, but they will also help students to develop a rich body of knowledge and ways of thinking, which are essential qualities for scientists and technological experts.

This university serves as a bridge among countries, with teams of excellent instructors to provide students with foreign language guidance. We invite students to take full advantage of the opportunities provided by this superlative learning environment. In order to have no regrets in the future, we encourage students to master foreign languages while they are at university and their memory is still sharp.

Academic Skills 1–4 are compulsory subjects. Please see p.51.

In addition, for those wishing to take a Japanese language classes, up to eight credits can be included toward their graduation requirements for an elective course in General Studies (Zengaku Kyotsu Kamoku).

2) Health and Physical Education

Needless to say, maintaining and improving health is important. This is particularly important for students in the Faculty of Science and Technology. Not only they have to conduct numerous experiments and attend seminars at the university, but also career after graduation in the industry and laboratories may require a high degree of physical and mental strength. Therefore, students should not only enroll in “Wellness, the Body and Culture” course among the health and physical education options, but also participate in extracurricular sports activities (in a manner that does not hamper their academic performance) to improve their overall physical strength and maintain a healthy lifestyle.

3. Specialized Education (Gakka Kamoku)

There are four types of Specialized Education (Gakka Kamoku): 1), 2) Faculty of Science and Technology Common Subject Group I and II (which are required for all students in the Faculty of Science and Technology), 3) Core Courses that form the main course groups of each department and 4) Specialized Courses offered by each department. Among these are compulsory courses, compulsory elective courses, elective courses, and optional courses. The optional courses refer to those subjects in which credits are not counted toward graduation.

For the Faculty of Science and Technology General Subject Group I and II, students are not permitted to enroll in courses other than those included in the English course (i.e., courses in Japanese). However, for the Core courses and Specialized courses, students are permitted to enroll in courses other than those from the English Course.

1) Faculty of Science and Technology General Subject Group I

The Faculty of Science and Technology Common Subject Group I includes introductory courses related to science and technology that aim to broaden students’ knowledge of these fields. This group includes “English for Science and Engineering”.

2) Faculty of Science and Technology General Subject Group II

This group contains courses that students are required to take in preparation for Core Courses and Specialized Courses. Students can transfer surplus credits from compulsory elective courses to elective courses in the Faculty of Science and Technology Common Subject Group II.

3) Department Core Courses

Department Core Courses are the groups of courses that form the core curriculum for each department, including experiments, seminars, and graduation research. Experiment-based courses are merged with courses that are taught in Japanese by experienced teaching staff or international teaching assistants. Seminars and graduation research are supervised by faculties who accept the students.

4) Department Specialized Courses

Regarding elective courses among department courses, the number of credits that students are able to allocate from the elective English courses in other departments in Faculty of science and Technology is up to half of the credits required for graduation.

4. Graduate School

The graduate school at this university offer master's degree programs and doctoral degree programs. Master's degree programs are of two years duration; upon completion students will earn a master's degree. Given that science and technology includes many different fields, the graduate school provides students with a highly specialized education that is based on the knowledge acquired in their undergraduate studies. With advances in science and technology, there is an increasing demand for people to earn masters or doctoral degrees. In addition, reducing the length of study for postgraduate degrees is under consideration. Therefore, we invite students currently enrolled in undergraduate programs to consider continuing their studies at the postgraduate level.

5. Qualifications

By taking the required courses and graduating from one of the departments in this faculty, students can obtain a number of qualifications which may serve as the prerequisite for test(s) and/or obtaining licenses. Please refer to the Japanese version of the Bulletin of information (履修要覧) for more details of the main qualifications.

6. Faculty of Science and Technology Early Graduation System

Early graduation refers to students who have spent three and half years or more at the university (excluding periods of leave of absence from the university) fulfilled for the prescribed procedures, and graduate upon completion of seven semesters year (hereafter 4th year March graduation).

Department of Materials and Life Sciences

Bachelor's Program in Green Science

1. Courses and Minimum Number of Credits required for Graduation

【For students who entered in 2012】

General Studies (Zengaku Kyotsu Kamoku)

Compulsory: 10 credits (Health and Physical Education: 2 credits, Foreign Languages: 8 credits (English))

Compulsory electives: 4 credits (Studies in Christian Humanism)

Electives: 16 credits

Specialized Education (Gakka Kamoku)

Compulsory: 31 credits

Compulsory electives: 11 credits

Electives: 52 credits

Total: 124 credits is required for graduation.

2. Number of Credits Necessary for Graduation

【For students who entered in 2012】

Please see P.67

3. Details to Note When Choosing courses

【For students who entered from 2012】

1) General Studies (Zengaku Kyotsu Kamoku)

(1) In addition to the 10 credits from compulsory subjects (such as foreign languages, and “Wellness, the Body and Culture”), students must take 4 credits (“Studies in Christian Humanism”) or more from compulsory elective courses and 16 credits or more from elective courses.

(2) In foreign languages, 8 credits must be taken from English.

2) Specialized Education (Gakka Kamoku)

(1) Classification of Specialized Education (Gakka Kamoku)

Faculty of Science and Technology General Subject Group I:

These are fundamental courses taken by all students in the Faculty of Science and Technology. Courses in this group consist of compulsory courses (18 credits) and compulsory elective courses (English for Science and Engineering (2 credits)).

Faculty of Science and Technology General Subject Group II:

This group is a continuation from Group I, which consists of common subjects that form the foundations for studying specialized courses. While these courses are taken by all students in the Faculty of Science and Technology, some courses are particularly relevant for certain departments. Therefore, such subjects are designated as compulsory elective courses by the department. To graduate, students need 26 credits from this particular group, which includes 6 credits from the compulsory elective courses.

Department Core Courses:

Courses in this group form the educational core in each department and include experiments, exercises, seminars, and graduation research. Some of the experiment-based and practical courses are compulsory elective courses while others are compulsory courses. Combined, 16 credits from this group must be completed.

Department Specialized Courses:

These specialized courses offered by each department are elective. Students are required to take 32 credits from these courses in order to graduate.

(2) Credits required for Graduation

To graduate, students are required to have obtained a total of 94 credits from Specialized Education (Gakka Kamoku): 31 credits from compulsory courses, 11 credits from compulsory elective courses, and 52 credits from elective courses.

(3) English for Science and Engineering

Students are required to take the compulsory elective courses “ENGL. FOR SCI/ENGINEERING” from the Faculty of Science and Technology Common Subject Group I. Among the several sections of this course, the Environment section is strongly recommended.

(4) Faculty of Science and Technology Common Subject Group II

Students must complete 6 credits or more from the compulsory elective courses in this group specified by their department. If students obtain more than 6 credits, they can count these extra credits toward the Faculty of Science and Technology Common Subject Group II elective courses. Combined with excess credits from compulsory elective courses, students must take 20 credits from the elective courses in this group.

(5) Experiment-based and Practical Subjects from Department Core Courses

Students must obtain 13 credits from the compulsory courses in the Department Core Courses group.

In addition, they must take 3 or more credits combined with compulsory elective courses from the Department Core Courses group other than English Courses.

(6) Department Specialized Courses

32 credits or more must be completed from elective courses.

3) Requirements for Registering Graduation Research

- (1) To take Graduation Research I, the total number of remaining credits out of the minimum number of credits from subjects required for graduation (124 credits) must be 20 credits or below, including the 3 credits for Graduation Research I and II.
- (2) To take Graduation Research II, students must have completed Graduation Research I.
- (3) Normally, students take Graduation Research I in the autumn semester of the 4th year. However, those who meet the above conditions and wish to take it in the spring semester should inform their department.

4) Limit on the Number of credits per Year/Semester

The following limitations apply to the number of credits that can be registered in each academic year and semester.

(Note 1) The number of credits taken throughout the year is to be distributed proportionately between the Autumn and the Spring (1/2).

(Note 2) Even if students are within the limits for registering credits in the Autumn and Spring semesters, the total number of credits registered in both semesters cannot exceed the annual limit.

(Note 3) Those who have registered for the Teacher Certification Program are permitted to register for additional courses exceeding the limit of the semester after they have registered for the program, which is up to 6 credits in each semester (10 credits each year) from their 2nd year.

(Credits)

1 st Year			2 nd Year			3 rd Year			4 th Year			Total
Aut	Spr	Annual Limit	Aut	Spr	Annual Limit	Aut	Spr	Annual Limit	Aut	Spr	Annual Limit	
26	27	49	27	26	49	25	27	49	26	27	49	196

Department of Engineering and Applied Sciences

Bachelor's Program in Green Engineering

1. Courses and Minimum Number of Credits required for Graduation

【For students who entered in 2012】

General Studies (Zengaku Kyotsu Kamoku)

Compulsory: 10 credits (Health and Physical Education: 2 credits, Foreign Languages: 8 credits (English))

Compulsory electives: 4 credits (Studies in Christian Humanism)

Electives: 16 credits

Specialized Education (Gakka Kamoku):

Compulsory: 28 credits

Compulsory electives: 23 credits

Electives: 43 credits

Total: 124 credits is required for graduation.

2. Number of Credits Necessary for Graduation

【For students who entered in 2012】

Please see P.68

3. Details to Note when Choosing courses

【For students who entered from 2012】

1) General Studies (Zengaku Kyotsu Kamoku)

(1) In addition to 10 credits from compulsory subjects (such as foreign languages, and “Wellness, the Body and Culture”), students must take 4 credits (“Studies in Christian Humanism”) or more from compulsory elective courses and 16 credits or more from elective courses.

(2) In foreign languages, 8 credits must be taken from English.

2) Specialized Education (Gakka Kamoku)

(1) Classification of Specialized Education (Gakka Kamoku)

Faculty of Science and Technology General Subject Group I:

These are fundamental courses taken by all students in the Faculty of Science and Technology. Courses in this group consist of compulsory courses (18 credits) and compulsory elective courses (English for Science and Engineering (2 credits)).

Faculty of Science and Technology General Subject Group II:

This group is a continuation from Group I, which consists of common subjects that form the foundations for studying specialized courses. While these courses are taken by all students in the Faculty of Science and Technology, some courses are particularly relevant toward certain departments. Therefore, such subjects are designated as compulsory elective courses by the department. To graduate, students need 25 credits from this particular group, which includes 14 credits from compulsory elective courses.

Department Core Courses:

Courses in this group form the core elements of study in each department and include experiments, exercises, seminars, and graduation research. Some experiment-based and practical courses are compulsory elective courses while others are compulsory courses. Combined, 17 credits from this group must be completed.

Department Specialized Courses:

These specialized courses offered by each department are elective. Students are required to obtain 32 credits from these courses in order to graduate.

(2) Credits required for Graduation

To graduate, students are required to have a total of 94 credits from Specialized Education (Gakka Kamoku): 28 credits from compulsory courses, 23 credits from compulsory elective courses, and 43 credits from elective courses.

(3) English for Science and Engineering

Students are required to take the compulsory elective courses “ENGL. FOR SCI/ENGINEERING” from the Faculty of Science and Technology General Subject Group I. Among several subjects, Environment is strongly recommended.

(4) Faculty of Science and Technology General Subject Group II

Students must complete 14 credits or more from the compulsory elective courses in this group specified by their department. If students obtain more than 14 credits, they can count as credits toward the Faculty of Science and Technology General Subject Group II elective courses. Combined with excess credits from compulsory elective courses, students must take 11 credits from the elective courses in this group.

(5) Experiment-based and Practical Subjects from Department Core Courses

Students must obtain 10 credits from the compulsory courses in the Department Core Courses group.

In addition, they must take 7 or more credits combined with compulsory elective courses from the Department Core Courses group other than English Courses.

(6) Department Specialized Courses

32 credits or more must be completed from elective courses.

3) Requirements for Registering Graduation Research

- (1) To take Graduation Research I, the total number of remaining credits out of the minimum number of credits from subjects required for graduation (124 credits) must be 20 credits or below, including 2 credits from Graduation Research I and II.
- (2) To take Graduation Research II, students must have completed Graduation Research I.
- (3) Normally, students take Graduation Research I in the autumn semester of the 4th year. However, those who meet the above conditions and wish to take it in the spring semester should inform their department.

4) Limit on the Number of credits per Year/Semester

The following limitations apply to the number of credits that can be registered in each academic year and semester.

(Note 1) The number of credits taken throughout the year is to be distributed proportionately between the Autumn and the Spring (1/2).

(Note 2) Even if students are within the limits for registering credits in the Autumn and Spring semesters, the total number of credits registered in both semesters cannot exceed the annual limit.

(Note 3) Those who have registered for the Teacher Certification Program are permitted to register for additional courses exceeding the limit of the semester after they have registered for the program, which is up to 6 credits in each semester (10 credits per year) from their 2nd year.

(Credits)

1 st Year			2 nd Year			3 rd Year			4 th Year			Total
Aut	Spr	Annual Limit	Aut	Spr	Annual Limit	Aut	Spr	Annual Limit	Aut	Spr	Annual Limit	
26	27	49	27	26	49	25	27	49	26	27	49	196

Department of Material and Life Sciences (Green Science)

O General Studies (Zengaku Kyozai Kamoku) (30credits)

	1st Year		2nd Year		3rd Year		4th Year	
	Autumn Semester course title	cr	Autumn Semester course title	cr	Autumn Semester course title	cr	Autumn Semester course title	cr
Compulsory	Zcr Health and Physical Education	2						
Compulsory/Elective	4cr Studies in Christian Humanism	4						
Elective	Japanese The Legacy of the Past 18cr Cultural Traditions The Contemporary World General Studies Elective Courses							
Foreign Language Compulsory	8cr Academic Skills 1	2	Academic Skills 2	2	Academic Skills 3	2	Academic Skills 4	2

O Specialized Education (Gakka Kamoku) (94credits)

	1st Year		2nd Year		3rd Year		4th Year	
	Autumn Semester course title	cr	Autumn Semester course title	cr	Autumn Semester course title	cr	Autumn Semester course title	cr
Faculty of Science and Technology General Subject Group I	Compulsory	2	OVERVIEW OF SCIENCE & TECHNOLOGY	2				
	Compulsory	2	INTRO. TO SCIENCE & TECHNOLOGY	2	BASIC INFORMATICS	2		
Compulsory Elective	2cr	2	MATHEMATICS (LINEAR ALGEBRA)	2				
	6cr	2	MATHEMATICS (CALCULUS)	2				
Faculty of Science and Technology General Subject Group II	Compulsory	1	BASIC PHYSICS	2				
	Compulsory	2	MATHEMATICS EXERCISE 1	1				
Compulsory Elective	2cr	2	BASIC CHEMISTRY	2				
	2cr	2	BASIC BIOLOGY	2				
Faculty of Science and Technology General Subject Group	Compulsory	1	EXPERIMENTS & EXERCISE OF BASIC SCIENCE	1				
	2cr	2	ENGL FOR SCIENCE/ENGINEERING	2				
Faculty of Science and Technology General Subject Group	Compulsory	2	MOLECULAR BIOLOGY	2				
	2cr	2	LIFE CYCLE ASSESSMENT	2				
Department Core Courses	Compulsory	2	ORGANIC CHEMISTRY (ANALYTICAL CHEMISTRY)	2				
	2cr	2	ORGANIC CHEMISTRY	2				
Department Specialized Courses	Compulsory	2	MATHEMATICS (STATISTICAL DATA ANALYSIS)	2	FOURIER & LAPLACE TRANSFORMS	2		
	2cr	2	BASIC DIFFERENTIAL EQUATIONS	2	GEOSCIENCE	2		
Department Core Courses	Compulsory	2	GLOBAL REGIONAL AND LOCAL ENVIRONMENTAL ISSUES	2	ATOMIC & MOLECULAR SCIENCES	2		
	2cr	2	PHYSICAL CHEMISTRY	2	CELL BIOLOGY	2		
Department Core Courses	Compulsory	2	MATERIALS AND LIFE SCIENCES (PHYSICS)	2	MATERIALS AND LIFE SCIENCES LAB. B	1		
	2cr	2	MATERIALS AND LIFE SCIENCES (CHEMISTRY)	2	MATERIALS AND LIFE SCIENCES LAB. C	1		
Department Core Courses	Compulsory	2	MATERIALS AND LIFE SCIENCES (BIOLOGY)	2	MATERIALS AND LIFE SCIENCES LAB. A	1		
	2cr	2	MATERIALS AND LIFE SCIENCES LAB. A	1				
Department Specialized Courses	Compulsory	2	日本語のコア選択必修科目	2	CHEMISTRY LAB. 1	1		
	2cr	2	ATOMIC AND MOLECULAR SPECTROSCOPY	2	1-2 MATERIALS SCIENCE LAB.	1		
Department Specialized Courses	Compulsory	2	INSTRUMENTAL ANALYSIS	2	ORGANIC AND NATURAL PRODUCT CHEMISTRY	2		
	2cr	2	CATALYSIS ENGINEERING	2	ENVIRONMENTAL ANALYTICAL CHEMISTRY	2		
Department Specialized Courses	Compulsory	2	CERAMICS & GLASS MATERIALS	2	GREEN CHEMISTRY	2		
	2cr	2	THEORY-ADDED MOLECULAR DESIGN	2	SCIENCE OF RADIATION MEASUREMENTS	2		
Department Specialized Courses	Compulsory	2	QUANTUM REACTION DYNAMICS	2	TOPICS OF GREEN SCIENCES 1	2		
	2cr	2	TOPICS OF GREEN SCIENCES 2	2	TOPICS OF GREEN SCIENCES 2	2		
Department Specialized Courses	Compulsory	1	SEMIMAR 1	1	SEMIMAR 1	1		
	1cr	1	GRADUATION RESEARCH 1	1	GRADUATION RESEARCH 2	1		

Department of Engineering and Applied Sciences (Green Engineering)

○General Studies (Zengaku Kyotau Kamoku) (30credits)

	1st Year		2nd Year		3rd Year		4th Year	
	Autumn Semester course title	Spring Semester course title	Autumn Semester course title	Spring Semester course title	Autumn Semester course title	Spring Semester course title	Autumn Semester course title	Spring Semester course title
Compulsory	2cr Health and Physical Education 2							
Compulsory Elective	4cr Studies in Christian Humanism	4						
Elective	Japanese							
	The Legacy of the Past 16cr Cultural Traditions The Contemporary World General Studies Elective Courses							
Foreign Language Compulsory	8cr Academic Skills 1	2 Academic Skills 2	2 Academic Skills 3	2 Academic Skills 4	2			

○Specialized Education (Gakka Kamoku) (9Credits)

	1st Year		2nd Year		3rd Year		4th Year	
	Autumn Semester course title	Spring Semester course title	Autumn Semester course title	Spring Semester course title	Autumn Semester course title	Spring Semester course title	Autumn Semester course title	Spring Semester course title
Faculty of Science and Technology General Subject Group I	SCHEMATIC OF SCIENCE & TECHNOLOGY INTRO. TO SCIENCE & TECHNOLOGY		2cr BASIC INFORMATICS					
	2 MATHEMATICS ALGEBRA 2 MATHEMATICS B(CALCULUS) 2 MATHEMATICS EXERCISE 1 1 BASIC PHYSICS 2 BASIC CHEMISTRY 2 BASIC BIOLOGY 2 EXPERIMENTS & EXERCISE OF BASIC SCIENCE 1		2					
Compulsory Elective	2cr	ENGLFOR SCI/ENGINEERING						
Faculty of Science and Technology General Subject Group II	2 MATHEMATICS B(CALCULUS OF SEVERAL VARIABLES) 2 BASIC DIFFERENTIAL EQUATIONS 2 GLOBAL, REGIONAL AND LOCAL ENVIRONMENTAL ISSUES		2 MATHEMATICS B(CALCULUS OF SEVERAL VARIABLES) 2 MOLECULAR BIOLOGY 2 THERMODYNAMICS 2 ATOMIC & MOLECULAR SCIENCES 2 LIFE CYCLE ASSESSMENT		2 ENGLFOR SCI/ENGINEERING 2 MATHEMATICS B(CALCULUS OF SEVERAL VARIABLES) 2 MOLECULAR BIOLOGY 2 THERMODYNAMICS 2 ATOMIC & MOLECULAR SCIENCES 2 LIFE CYCLE ASSESSMENT		2 ENGLFOR SCI/ENGINEERING 2 MATHEMATICS B(CALCULUS OF SEVERAL VARIABLES) 2 MOLECULAR BIOLOGY 2 THERMODYNAMICS 2 ATOMIC & MOLECULAR SCIENCES 2 LIFE CYCLE ASSESSMENT	
	2 EXPERIMENTS & EXERCISE OF BASIC SCIENCE 1		2 ENGLFOR SCI/ENGINEERING 2 MATHEMATICS B(CALCULUS OF SEVERAL VARIABLES) 2 MOLECULAR BIOLOGY 2 THERMODYNAMICS 2 ATOMIC & MOLECULAR SCIENCES 2 LIFE CYCLE ASSESSMENT		2 ENGLFOR SCI/ENGINEERING 2 MATHEMATICS B(CALCULUS OF SEVERAL VARIABLES) 2 MOLECULAR BIOLOGY 2 THERMODYNAMICS 2 ATOMIC & MOLECULAR SCIENCES 2 LIFE CYCLE ASSESSMENT		2 ENGLFOR SCI/ENGINEERING 2 MATHEMATICS B(CALCULUS OF SEVERAL VARIABLES) 2 MOLECULAR BIOLOGY 2 THERMODYNAMICS 2 ATOMIC & MOLECULAR SCIENCES 2 LIFE CYCLE ASSESSMENT	
Elective	11cr		2 ORGANIC CHEMISTRY 2 PHYSICAL CHEMISTRY 2 ENGINEERING AND APPLIED SCIENCES LAB. 2		2 CELL BIOLOGY 2 INTRODUCTION TO QUANTUM MECHANICS		2 GRADUATION RESEARCH 1	
	10cr		2 ENGINEERING AND APPLIED SCIENCES 1 2 ENGINEERING AND APPLIED SCIENCES 2 2 ENGINEERING AND APPLIED SCIENCES 3 2 ENGINEERING AND APPLIED SCIENCES LAB. 1 1 GREEN ENGINEERING LAB. 1		2 CELL BIOLOGY 2 INTRODUCTION TO QUANTUM MECHANICS		2 GRADUATION RESEARCH 1	
Compulsory Elective	7cr	GREEN ENGINEERING LAB. 3						
Department Specialized Courses	2 FLUID ENERGY CONVERSION 2 INTRODUCTION TO MATERIAL SCIENCES 2 ELECTRICAL DRIVES AND CONTROLS 2 CLEAN ENERGY 2 COMMUNICATION AND NETWORK ENGINEERING		2 FLUID ENERGY CONVERSION 2 INTRODUCTION TO MATERIAL SCIENCES 2 ELECTRICAL DRIVES AND CONTROLS 2 CLEAN ENERGY 2 COMMUNICATION AND NETWORK ENGINEERING		2 FLUID ENERGY CONVERSION 2 INTRODUCTION TO MATERIAL SCIENCES 2 ELECTRICAL DRIVES AND CONTROLS 2 CLEAN ENERGY 2 COMMUNICATION AND NETWORK ENGINEERING		2 FLUID ENERGY CONVERSION 2 INTRODUCTION TO MATERIAL SCIENCES 2 ELECTRICAL DRIVES AND CONTROLS 2 CLEAN ENERGY 2 COMMUNICATION AND NETWORK ENGINEERING	
	2 FLUID ENERGY CONVERSION 2 INTRODUCTION TO MATERIAL SCIENCES 2 ELECTRICAL DRIVES AND CONTROLS 2 CLEAN ENERGY 2 COMMUNICATION AND NETWORK ENGINEERING		2 FLUID ENERGY CONVERSION 2 INTRODUCTION TO MATERIAL SCIENCES 2 ELECTRICAL DRIVES AND CONTROLS 2 CLEAN ENERGY 2 COMMUNICATION AND NETWORK ENGINEERING		2 FLUID ENERGY CONVERSION 2 INTRODUCTION TO MATERIAL SCIENCES 2 ELECTRICAL DRIVES AND CONTROLS 2 CLEAN ENERGY 2 COMMUNICATION AND NETWORK ENGINEERING		2 FLUID ENERGY CONVERSION 2 INTRODUCTION TO MATERIAL SCIENCES 2 ELECTRICAL DRIVES AND CONTROLS 2 CLEAN ENERGY 2 COMMUNICATION AND NETWORK ENGINEERING	

Course List

Common Subjects in the Faculty of Science and Technology

Course List

	Course title [Course No.]	Cr.	Semester offered	Instructor (Tentative)
Faculty of Science and Technology Common Subject Group I	OVERVIEW OF SCIENCE & TECHNOLOGY [SCT1010E]	2	AUT	Denielache Sebastian
	INTRO. TO SCIENCE & TECHNOLOGY [SCT1140E]	2	AUT	Invited Foreign Professors
	MATHEMATICS A(LINEAR ALGEBRA)	2	SPR	undecided
	MATHEMATICS B(CALCULUS)	2	SPR	undecided
	MATHEMATICS EXERCISE 1	1	SPR	undecided
	BASIC PHYSICS	2	SPR	Invited Foreign Professors
	BASIC CHEMISTRY	2	SPR	Denielache Sebastian
	BASIC BIOLOGY	2	SPR	TAMIYA, Toru
	BASIC INFORMATICS	2	AUT	TAKAOKA, Eiko
	EXPERIMENTS & EXERCISE OF BASIC SCIENCE	1	SPR	Denielache Sebastian
ENGL.FOR SCI/ENGINEERING (ENVIRONMENT)	2	SPR	undecided	
Faculty of Science and Technology Common Subject Group II	MATHEMATICS C1 (STATISTICAL DATA ANALYSIS)	2	SPR	KATO, Takeshi
	MOLECULAR BIOLOGY	2	SPR	FUJIWARA, Makoto
	MATHEMATICS B2 (CALCULUS OF SEVERAL VARIABLES)	2	AUT	Shona Humin Yu
	BASIC DIFFERENTIAL EQUATIONS	2	AUT	Shona Humin Yu
	INORGANIC CHEMISTRY(ANALYTICAL CHEMISTRY)	2	SPR	part-time lecturer
	ORGANIC CHEMISTRY	2	SPR	SUZUKI, Yumiko
	PHYSICAL CHEMISTRY	2	SPR	Denielache Sebastian
	FOURIER & LAPLACE TRANSFORMS	2	AUT	Shona Humin Yu
	THERMODYNAMICS	2	SPR	part-time lecturer
	CELL BIOLOGY	2	AUT	HAYASHI, Kensuke
	INTRODUCTION TO QUANTUM MECHANICS	2	AUT	HIRANO, Tetsufumi
	ATOMIC & MOLECULAR SCIENCES	2	SPR	Invited Foreign Professors
	GEOSCIENCE	2	AUT	part-time lecturer
	LIFE CYCLE ASSESSMENT	2	SPR	SAKAMA, Hiroshi
GLOBAL, REGIONAL AND LOCAL ENVIRONMENTAL ISSUES	2	AUT	HUANG, Guangwei	

Department of Materials and Life Sciences (Green Science)

Course List

	Course title [Course No.]	Cr.	Semester offered	Instructor (Tentative)
Department Core Courses	MATERIALS AND LIFE SCIENCES (PHYSICS)	2	AUT	OHTSUKI, Tomi
	MATERIALS AND LIFE SCIENCES (CHEMISTRY)	2	AUT	Denielache Sebastian
	MATERIALS AND LIFE SCIENCES (BIOLOGY)	2	AUT	SAITO, Tamao
	MATERIALS AND LIFE SCIENCES LAB. A	1	AUT	undecided
	MATERIALS AND LIFE SCIENCES LAB. B	1	SPR	Denielache Sebastian
	MATERIALS AND LIFE SCIENCES LAB. C	1	AUT(FH)	undecided
	CHEMISTRY LAB. 1	1	AUT(LH)	undecided
	CHEMISTRY LAB. 2	1	SPR(FH)	undecided
	MATERIALS SCIENCE LAB.	1	SPR(LH)	undecided
	SEMINAR 1	1	AUT	-
	SEMINAR 2	1	SPR	-
	GRADUATION RESEARCH 1	1	AUT	-
	GRADUATION RESEARCH 2	1	SPR	-
Department Specialized Courses	ATOMIC AND MOLECULAR SPECTROSCOPY	2	AUT	AZUMA, Yoshiro
	INSTRUMENTAL ANALYSIS	2	AUT	ENDO, Akira
	ORGANIC AND NATURAL PRODUCT CHEMISTRY	2	SPR	USUKI, Toyonobu
	ENVIRONMENTAL ANALYTICAL CHEMISTRY	2	SPR	Denielache Sebastian
	GREEN CHEMISTRY	2	SPR	HORIKOSHI, Satoshi
	SCIENCE OF RADIATION MEASUREMENTS	2	SPR	ODAGIRI, Takeshi
	CATALYSIS ENGINEERING	2	AUT	SUZUKI, Noriyuki
	CERAMICS & GLASS MATERIALS	2	AUT	ITATANI, Kiyoshi
	THEORY-AIDED MOLECULAR DESIGN	2	AUT	NANBU, Shinkoh
	QUANTUM REACTION DYNAMICS	2	AUT	HOSHINO, Masamitsu
	TOPICS OF GREEN SCIENCES 1	2	AUT	undecided
	TOPICS OF GREEN SCIENCES 2	2	AUT	undecided

Department of Engineering and Applied Sciences (Green Engineering)

Course List

	Course title [Course No.]	Cr.	Semester offered	Instructor (Tentative)
Department Core Courses	ENGINEERING AND APPLIED SCIENCES 1	2	AUT	SUEMASU, Hiroshi
	ENGINEERING AND APPLIED SCIENCES 2	2	AUT	OHTSUKI, Tomi
	ENGINEERING AND APPLIED SCIENCES 3	2	AUT	NAKAOKA, Toshihiro
	ENGINEERING AND APPLIED SCIENCES LAB. 1	1	AUT	TAKAYANAGI, Kazuo
	ENGINEERING AND APPLIED SCIENCES LAB. 2	1	SPR	HIRANO, Tetsufumi
	GREEN ENGINEERING LAB. 1	1	AUT	undecided
	GREEN ENGINEERING LAB. 2	1	SPR	undecided
	GREEN ENGINEERING LAB. 3	1	AUT	undecided
	TOPICS OF GREEN ENGINEERING 1	2	AUT	undecided
	TOPICS OF GREEN ENGINEERING 2	2	AUT	undecided
	GRADUATION RESEARCH 1	1	AUT	-
	GRADUATION RESEARCH 2	1	SPR	-
Department Specialized Courses	THERMAL ENERGY CONVERSION	2	AUT	SUZUKI, Takashi
	FLUID ENERGY CONVERSION	2	SPR	WATANABE, Mariko
	ENERGY & MATERIALS	2	AUT	TAKAI, Kenichi
	NUCLEAR ENGINEERING ENERGY	2	AUT	part-time lecturer
	INTRODUCTION TO MATERIAL SCIENCES	2	SPR	GOTO, Takayuki
	ELECTRICAL DRIVES AND CONTROLS	2	SPR	MIYATAKE, Masafumi
	ELECTRIC POWER SYSTEM ENGINEERING	2	AUT	SAKAMOTO, Ori
	CLEAN ENERGY	2	SPR	YAGAI, Tsuyoshi
	SIMULATION ENGINEERING	2	AUT	GONSALVES, Tad
	COMMUNICATION AND NETWORK ENGINEERING	2	SPR	BANDAI, Masaki OGAWA, Masakatsu HAYASHI, Hitoshi

General Information

Campus Map

… P. 74

Faculty Offices and Office Hours

… P. 83

Campus Map



Yotsuya Campus 四谷キャンパス

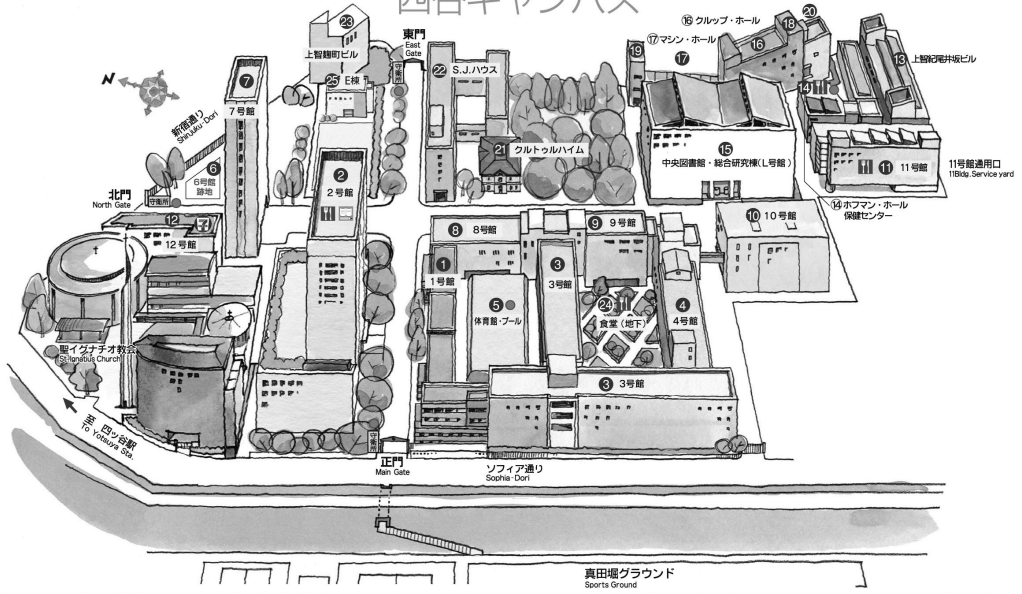

- | | | | | | |
|--------------------|-------------------------|---------------------------------------|----------------------------------|--|-----------------|
| ① 1号館 Bldg. No.1 | ⑥ 6号館附棟 Bldg. No.6 site | ⑫ 12号館 Bldg. No.12 | ⑮ クルップ・ホール Krupp Hall | ㉔ S.J.ハウス S.J. House | ㉚ E棟 (Bldg. E) |
| ② 2号館 Bldg. No.2 | ⑦ 7号館 Bldg. No.7 | ⑬ 上智紀元井坂ビル Jochi Kiozaka Bldg. | ⑯ マシン・ホール Machine Hall | ㉛ 上智麹町ビル Jochi Kojimachi Building | ㉜ 地下 (basement) |
| ③ 3号館 Bldg. No.3 | ⑧ 8号館 Bldg. No.8 | ⑭ ホフマン・ホール Hofmann Hall | ⑰ パワーステーションI Power Station I | ㉝ 購買 Maruzen Sophia Shop | ㉝ 地下 (basement) |
| ④ 4号館 Bldg. No.4 | ⑨ 9号館 Bldg. No.9 | ⑱ 保健センター Health Center | ⑲ パワーステーションII Power Station II | ㉞ レストラン Restaurant | ㉞ 地下 (basement) |
| ⑤ 体育館 Gymnasium | ⑩ 10号館 Bldg. No.10 | ⑳ 中央図書館 Central Library | ㉑ パワーステーションIII Power Station III | ㉟ AED (自動体外式除細動器) 学内5カ所 Automated External Defibrillator | ㉟ 地下 (basement) |
| ⑪ 11号館 Bldg. No.11 | ⑪ 11号館 Bldg. No.11 | ㉒ 総合研究棟 (L号館) and Research Institutes | ㉒ クルトゥルハイム Kulturheim | ㊱ コンビニエンスストア Convenience Store | ㊱ 地下 (basement) |

Location of Bulletin Boards in Building No. 2 1F

Announcements from the university offices to students are posted on the Loyola online bulletin board. Information which is not appropriate for posting on Loyola will be posted on the bulletin boards outside Building No 2.

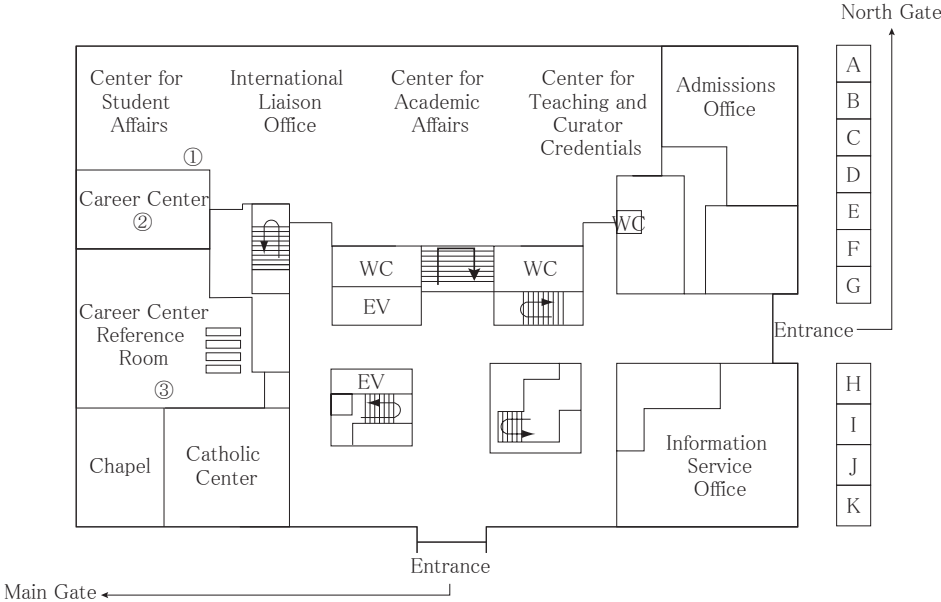
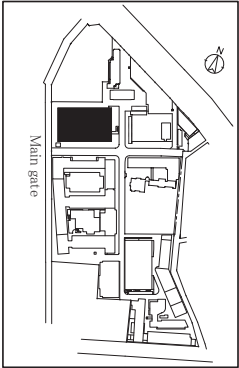

- ① Center for Student Affairs
- ② } Career Center
- ③ }
- A Admissions Office
- B } Campus Membership
- C }
- D } Center for Academic Affairs
- E }
- F }
- G }
- H } Center for Student Affairs
- I }
- J Career Center
- K International Liaison Office

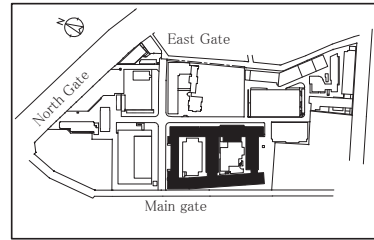

Building No. 1・3・4・8・9

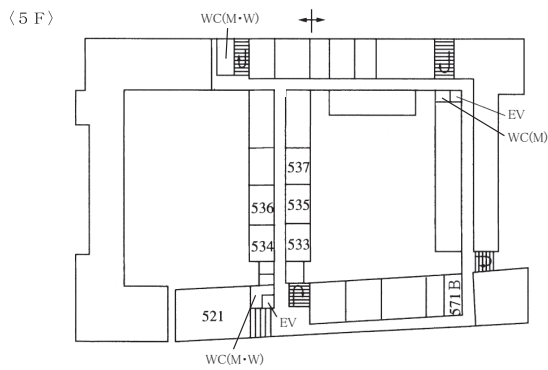
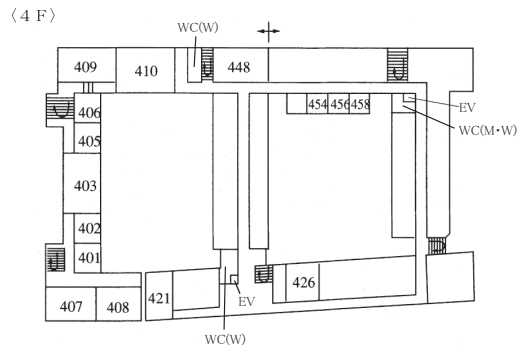
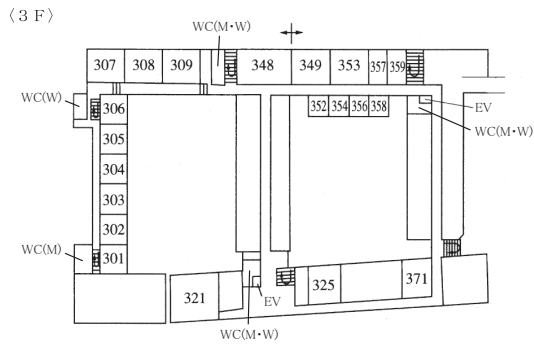
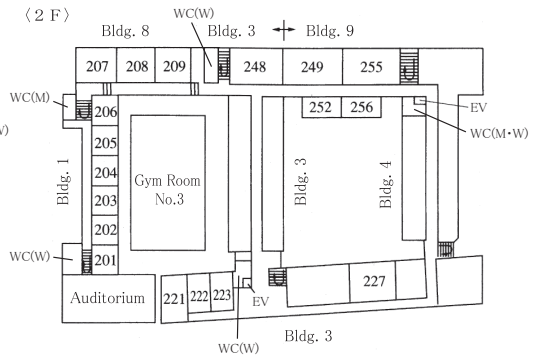
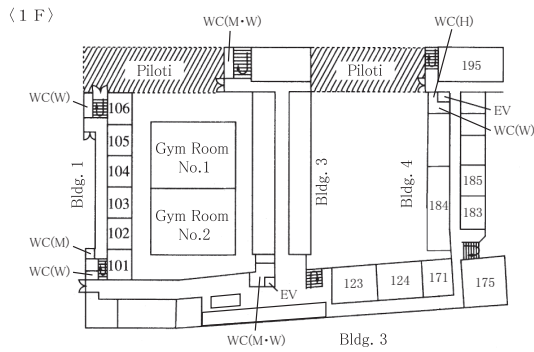

Building No. 2

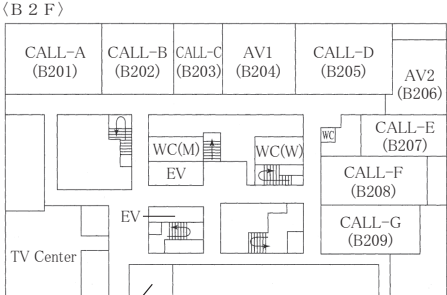
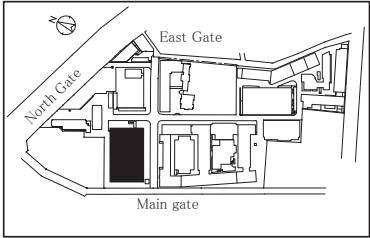

Center for the Teaching of Foreign Languages in General Education

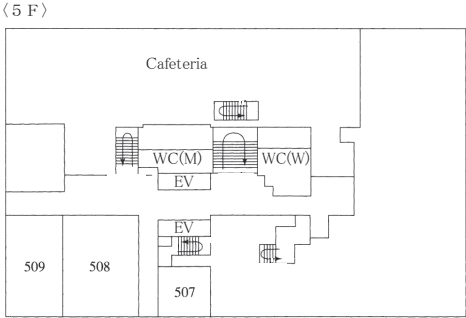
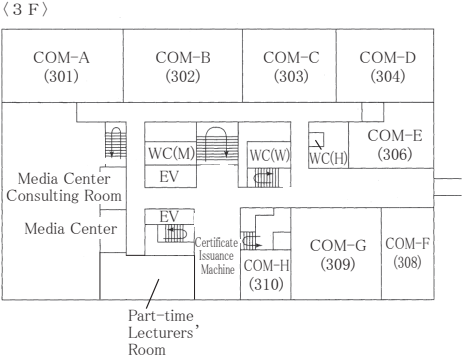
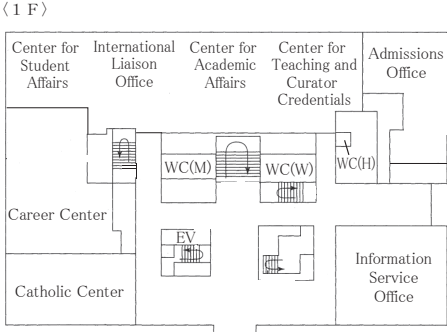
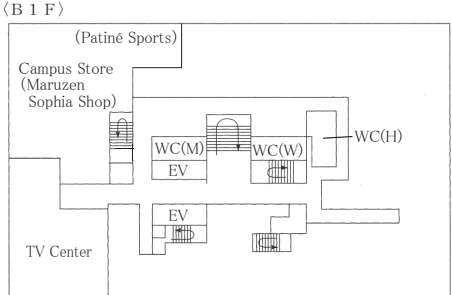

Central Library (Building L)

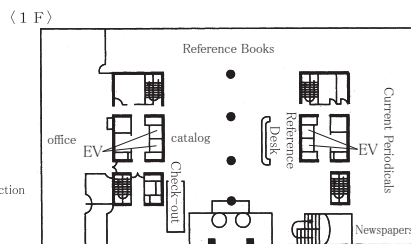
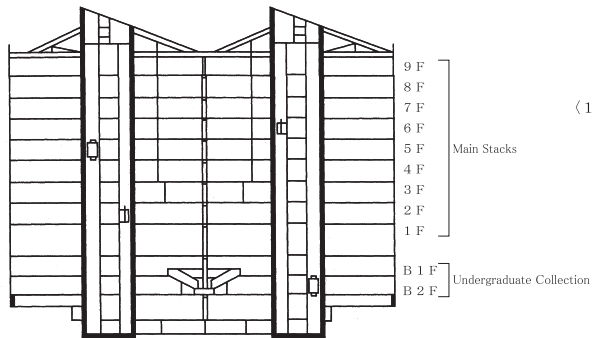
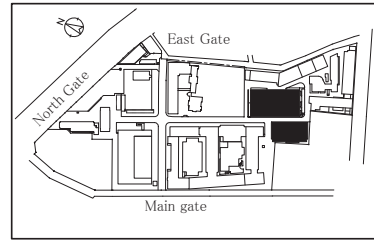

Building No. 10

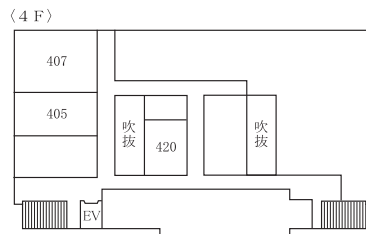
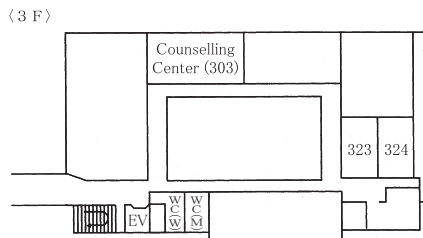
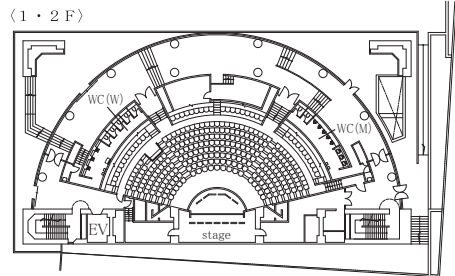
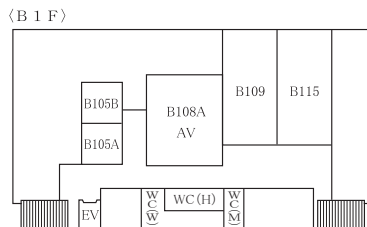

Building No. 11 & Jochi Kioizaka Building

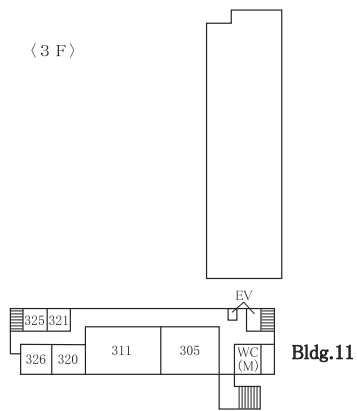
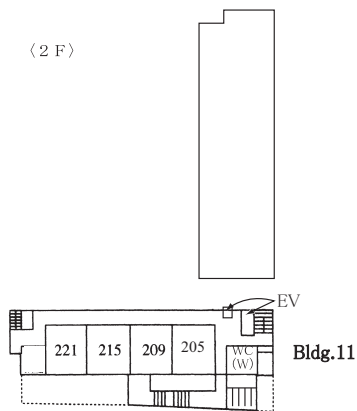
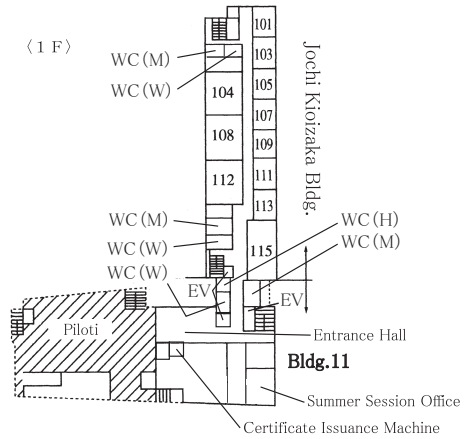
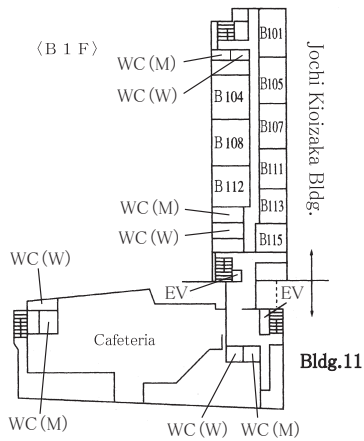
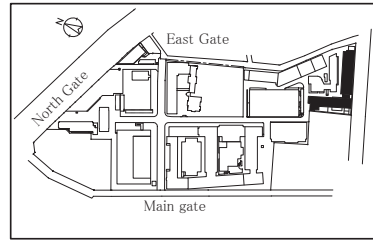

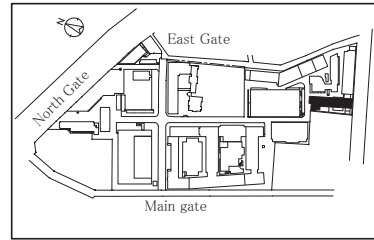

Building No. 11

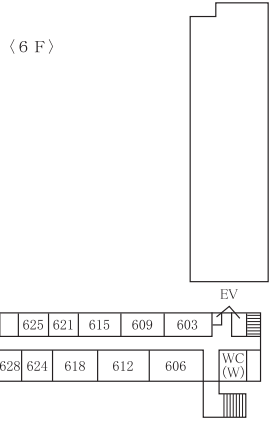
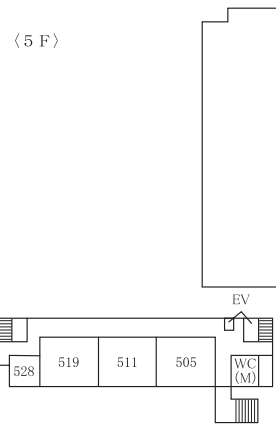
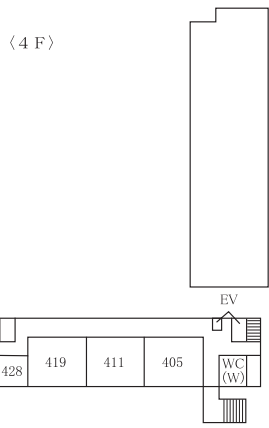

Building No. 12

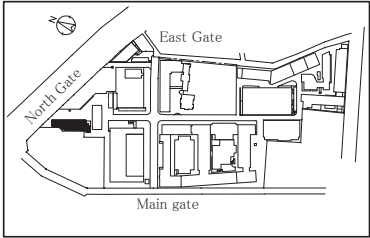

<B1F>

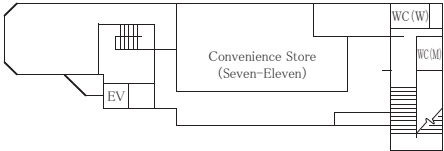

<1F>

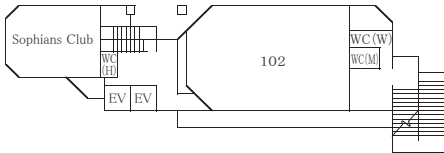

<2F>

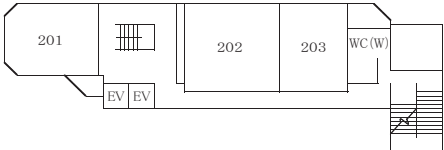

<3F>

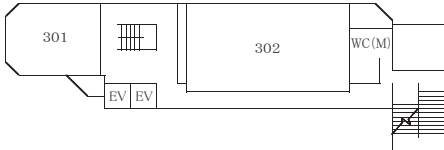

<4F>

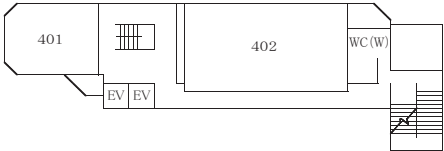

<5F>

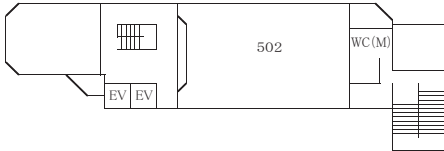

Building E

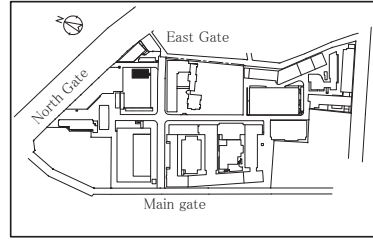

(1F)

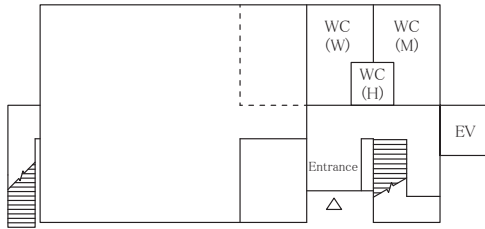

(2F)

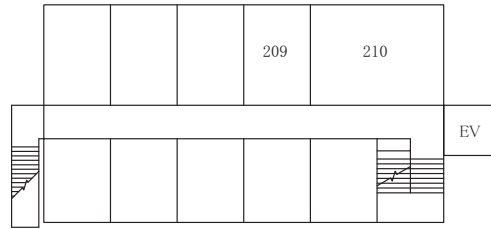

Faculty Offices and Office Hours

Faculty of Science and Technology

Dean's Office 4-590 (ex. 3300)

Department of Materials and Life Science

Chairperson's Office 3-431 (ex. 3360)

	Azuma, Yoshiro	4-391B	Mon - Fri		
	Chiba, Atsuhiko	9-752A	Mon - Fri	at any time by appointment	
	Endo, Akira	3-441A	Mon - Fri	at any time by appointment	
	Fujita, Masahiro	4-474B	Mon - Fri	at any time by appointment	
	Fujiwara, Makoto	9-559A	Mon - Fri	10:00 - 17:00 or by appointment	
	Hashimoto, Takeshi	3-439	Wed	15:00 - 18:00 or by appointment	
	Hayashi, Kensuke	9-758A	Mon	12:30 - 13:20 or by appointment	
Dean	Hayashita, Takashi	3-441B	Mon - Fri	at any time by appointment	
	Horikoshi, Satoshi	4-191	Mon - Fri	at any time by appointment	
	Hoshino, Masamitsu	4-385A	Mon - Fri		Except a lecture, meeting time
Chairperson	Itatani, Kiyoshi	3-445B	Mon - Fri	10:00 - 17:00	by e-mail appointment
	Kanzawa, Nobuyuki	3-433	Mon - Fri	10:00 - 17:00	Except a lecture, meeting time
	Kawaguchi, Mari	3-571A	Mon - Fri	at any time by appointment	
	Kikawada, Yoshikazu	4-482	Mon - Fri		by appointment
	Kobayashi, Kenichiro	9-554A	Mon	16:00 - 17:00	or by appointment
	Kondo, Jiro	4-383B	Mon - Fri	10:00 - 17:00	or by appointment
	Kuze, Nobuhiko	4-497	Mon - Fri	10:00 - 17:00	or by appointment
	Makino, Osamu	9-754A	Tue - Fri	at any time by appointment	
	Masuyama, Yoshiro	4-491A	Mon - Fri	at any time by e-mail appointment	
	Nagao, Hirotaka	4-491B	Mon - Fri	at any time by appointment	
	Nanbu, Shinkoh	9-452A	Mon - Fri	10:00 - 17:00 or by appointment	
	Odagiri, Takeshi	10-609	Mon - Fri	10:00 - 17:00 by appointment	
	Oi, Takao	9-452B	Mon - Fri	09:30 - 17:00 by appointment	
	Okada, Kunihiro	4-387B	Mon - Fri		by e-mail appointment
	Rikukawa, Masahiro	4-481	Mon - Fri	at any time by e-mail appointment	
	Saito, Tamao	3-531	Mon - Fri	10:00 - 17:00	by e-mail appointment (tasaito@sophia.ac.jp)
	Sugiyama, Toru	3-331	Mon - Fri	10:00 - 17:00	Except a lecture, meeting time
	Suzuki, Noriyuki	4-489	Mon - Fri	10:00 - 17:00	Except a lecture, meeting time
	Suzuki, Yumiko	3-435B	Mon - Fri	10:00 - 17:00	or by appointment
	Takahashi, Kazuo	4-495B	Mon - Fri	10:00 - 17:00 by appointment	
	Takeoka, Yuko	4-485	Mon - Fri	10:00 - 17:00 by appointment	
	Tamiya, Toru	3-435A	Mon - Fri	at any time by appointment	
	Tanaka, Kunihiro	4-493	Mon - Fri	10:00 - 17:00 or by appointment	
	Uchida, Hiroshi	3-446	Mon - Fri	at any time by e-mail appointment	
	Usuki, Toyonobu	4-474A	Mon - Fri	at any time	
	Yasumasu, Shigeki	3-525	Mon - Fri	at any time by appointment	

Department of Engineering and Applied Science

Chairperson's Office 3-131 (ex. 3310)

	Ema, Kazuhiro	3-345A	Mon - Fri		Except a lecture, meeting time
	Goto, Takayuki	3-335B	Mon - Fri	9:00 - 18:00	Except a lecture, meeting time
	Hirano, Tetsufumi	4-385B	Mon - Fri	at any time	by e-mail appointment
	Hisamori, Noriyuki	KH-426	Mon - Fri	11:00 - 17:00	
	Ichiyanagi, Mitsuhisa	3-138	Mon - Fri	at any time	by e-mail appointment
	Ikeo, shigeru	3-133A	Mon - Fri	at any time	by appointment
	Kikuchi, Akihiko	4-292	Mon - Fri	at any time	by appointment
	Kishino, Katsumi	3-235	Tue · Fri	12:30 - 13:30, Tue 16:00 - 18:00	by e-mail appointment

	Kunugita, Hideyuki	3-342	Mon - Fri	Except a lecture, meeting time
	Kuroe, Haruhiko	E-207	Mon - Fri	Except a lecture, meeting time by e-mail appointment
	Kuwahara, Hideki	4-381	Mon - Fri	Except a lecture, meeting time by appointment
	Miyatake, Masafumi	3-243B	Mon 16:30 - 18:45, Tue 13:00 - 14:00	or by appointment
	Mizugai, Yoshihiro	3-340	Mon - Fri 13:30 - 20:00	
	Muto, Yasuhiko	3-137A	Mon - Fri 11:00 - 17:00	by appointment
	Nagashima, Toshio	KH-228B	Mon - Fri at any time	by e-mail appointment
	Nakamura, Kazuya	4-296	Mon - Fri at any time	by appointment
	Nakaoka, Toshihiro	E-206	Mon - Fri at any time	by e-mail appointment
	Nomura, Ichiro	3-235	Tue - Fri	by e-mail appointment
	Ohtsuki, Tomi	4-389A	Mon · Tue 13:00 - 15:00	
	Sakama, Hioshi	3-341B	Mon - Fri at any time	by appointment
	Sakamoto, Haruhisa	KH-329	Mon - Fri 13:30 - 17:00	by appointment
	Sakamoto, Oriie	10-616	Mon - Fri at any time	by e-mail appointment
	Sato, Yoshihiro	KH-323	Mon - Fri 11:00 - 17:00	by appointment
	Sekine, Tomoyuki	3-341A	Mon - Fri	Except a lecture, meeting time by appointment
	Shimomura, Kazuhiko	3-239A	Mon - Fri at any time	by appointment
	Shen Tielong	3-137B	Mon - Fri 11:00 - 17:00	
	Shimizu, Shinji	KH-327	Mon - Fri 14:00 - 17:00	Except a lecture, meeting time by appointment
	Suemasu, Hiroshi	3-143B	Tue - Fri 11:00 - 17:00	
	Suzuki, Hiroshi	MH-115E	Mon - Fri 11:00 - 17:00	
	Suzuki, Takashi	3-135B	Mon - Fri at any time	
	Takai, Kenichi	KH-428	Mon - Fri 10:00 - 18:00	
Chairperson	Takao, Tomoaki	3-241A	Mon - Fri at any time	by e-mail appointment
	Takayanagi, Kazuo	4-383A	Mon - Fri 13:30 - 17:00	Except a lecture, meeting time by appointment
	Terumichi, Yoshiaki	3-143A	Mon - Fri at any time	by e-mail appointment (y-terumi@sophia.ac.jp)
	Tsukiji, Tetsuhiro	3-135A	Mon - Fri at any time	by appointment
	Watanabe, Mariko	3-133B	Mon - Fri at any time	by appointment
	Yagai, Tsuyoshi	E-201	Mon - Fri at any time	by appointment

Department of Information and Communication Science

Chairperson's Office 3-233 (ex. 3320)

	Arai, Takayuki	4-290	Mon - Fri at any time	by appointment
	Bandai, Masaki	3-243A	Mon - Fri at any time	by appointment
	Fujii, Mamiko	4-297	Mon - Fri at any time	by appointment
	Gomi, Yasushi	4-583A	at any time	by appointment
	Gonsalves, Tad	3-527A	sabbatical	
	Goto, Satoshi	4-584A	at any time	by e-mail appointment
	Hayashi, Hitoshi	E-202	Mon - Fri	by appointment
	Hirata, Hitoshi	4-587B	at any time	by appointment
	Ishida, Masashi	4-588A	Mon 12:30 - 13:30	
	Irohara, Takashi	KH-528	Tue 12:30 - 13:30	by appointment
	Ito, Kiyoshi	9-558B	Tue · Thu 12:40 - 13:20	by appointment
	Kato, Masahide	4-585A	Thu 12:45 - 13:30	
	Kato, Takeshi	4-585B	Fri 13:30 - 15:00	by appointment
	Kawabata, Ryo	3-527A	at any time	by appointment
	Kawanaka, Akira	4-273	Mon · Fri 12:30 - 13:30, Tue 13:30 - 15:00	
	Kudo, Teruhiko	4-291	Mon - Fri at any time	Except a lecture, meeting time
	Miyamoto, Yuichiro	KH-526	at any time	by e-mail appointment
Chairperson	Nakashima, Toshiki	4-583B	at any time	by appointment
	Niikura, Takako	9-756A	Mon - Fri	by appointment

Ogawa, Masakatsu	E-203	Mon - Fri at any time	by appointment
Sasakawa, Nobuyuki	9-754B	Mon - Fri at any time	by appointment
Shibuya, Tomoharu	4-293	Mon - Fri at any time	by e-mail appointment
Shinoda, Kenichi	4-589B	at any time (Inquiry required)	
Sumi, Chikayoshi	4-284C	Mon - Fri 13:00 - 13:30	by appointment
Tahara, Hidetoshi	4-591B	at any time	by appointment
Takaoka, Eiko	KH-530	Tue · Wed	by appointment
Tamura, Yasuhisa	10-608	Mon 15:00 - 17:00, Tue (only Autumn Semester) 13:30 - 15:00	by appointment
Tanaka, Mamoru	3-226	Mon - Fri 9:00 - 11:30, 15:00 - 19:00	
Tnaka, Shoji	3-241B	sabbatical	
Tsuji, Hajime	4-589A	Tue 12:30 - 13:30	
Tsunogai, Hiroshi	4-576	at any time	by appointment
Tsuzuki, Masao	4-584B	at any time	by appointment
Waho, Takao	4-284A	at any time	by appointment
Yairi, Ikuko	3-239B	at any time	by appointment
Yamanaka, Takao	3-237B	Mon - Fri 12:30 - 13:30	