

Index

Introduction	… P. 3
Common Guidelines	… P. 7
Academic Services	… P. 17
Academic Records	… P. 49
General Studies	… P. 59
Faculty of Science and Technology Curriculum	… P. 67
General Information	… P. 89

Introduction

The Educational Ideals of Sophia University

… P. 4

A Message to Students of Faculty of Science and Technology

… P. 5

INTRODUCTION

The Educational Ideals of Sophia University

Based on Christian principles of education, Sophia University attests to the Jesuit Order's four-hundred-year-old interest in Japan. Its aim is to prepare men and women coming from different countries to recognize the fundamental unity of the human race in the different cultural traditions of the world and to work for the concrete achievement of that unity. The roots of the university go back to 1549, when St. Francis Xavier, a Jesuit, landed in Kagoshima with the hope of starting a Catholic university which would introduce Western culture to Japan. In 1908, nearly 360 years later, three members of the Society of Jesus—the German Father Joseph Dahlmann, the French Father Henri Boucher, and the English Father James Rockliff came to Japan with the mission of fulfilling St. Francis Xavier's aspiration. As a result of their efforts, Sophia University was established in 1913, when the Japanese Ministry of Education gave the Jesuits permission to found a new educational institution under the Japanese name of Jōchi Gakuin. Sixteen students enrolled in the first class. Sophia University has grown from these modest beginnings to become one of Japan's foremost private universities with a student body of over 12,000 undergraduate and graduate students and a teaching staff of more than one thousand. In the tradition of the international character of Sophia's founders, the faculty members represent twenty different nationalities; they are committed to conveying both humankind's cultural and intellectual heritage and a concern for the problems facing the world today to the next generation through their scholarship and teaching.

A Message to Students of Faculty of Science and Technology

Welcome to our undergraduate programs.

In 2012, two new undergraduate programs taught entirely in English were added: The Green Science Program, which is offered by the Department of Materials and Life Sciences, and the Green Engineering Program, which is offered by the Department of Engineering and Applied Sciences.

Class sizes are kept to a minimum to enable students to communicate closely with professors as they pursue the field of their choice in science and technology, beginning with the basics, such as Mathematics, Physics, Chemistry, and Biology, and then continuing on to more advanced studies, such as Environmental Chemistry, Environmental Biotechnology, Clean Energy, and Environmental System Analyses.

As the campus is also home to liberal arts programs, students can enroll in non-science courses that would help enrich their cultural background and give them a broader perspective as they take on the challenge of pursuing environmental issues.

In addition, the Graduate School of Science and Technology introduced an international program taught in English, the Green Science and Engineering Division, in September 2013.

We invite you become a science and technology specialist and participate on the global stage as a Sophia University graduate.

Tetsuhiro TSUKIJI
Dean of the Faculty of Science and Technology
Sophia University

Loyola Web Service

The Loyola Web Service is the Official academic web portal of Sophia University. The Loyola Web Service (Loyola) brings together on one website important information and services related to academic matters.

Using the Loyola Web Service students will be able to:

- Search course schedule and classrooms
- Register and withdraw from courses
- Check their registration status and grades
- Check information concerning cancelled classes, make-up classes, or notices on the Loyola web bulletin board through PCs and mobile phones
- Update the registered data if there are any changes in the student's or guarantor's address
- Check and submit report assignments

Please refer to the "Loyola Handbook" (available online via Loyola) for detailed explanations on how to use Loyola.

Common Guidelines

2017 Calendar For the Academic Year	… P.8
Frequently Asked Questions	… P.12
Offices to visit for inquiries / office hours	… P.14
Announcements /Notices on Loyola	… P.15
Guidance Programs	… P.15
How to contact your teachers	… P.16
Change of address	… P.16
When public transport service is shut down	… P.16
Protection of Personal Information	… P.16

Common Guidelines

2017 Calendar For the Academic Year

Calendar		Academic Calendar																																										
<p>● : Vacation, National holidays, Saturdays.</p> <p>■ : Offices closed on days other than national holidays</p> <p>□ : Virtual Day</p>																																												
<p>2017</p> <p style="text-align: center;">April</p> <table border="1" style="width: 100%; text-align: center;"> <thead> <tr> <th>mon</th><th>tue</th><th>wed</th><th>thu</th><th>fri</th><th>sat</th><th>sun</th> </tr> </thead> <tbody> <tr> <td></td><td></td><td></td><td></td><td></td><td>1</td><td>2</td> </tr> <tr> <td>3</td><td>4</td><td>5</td><td>6</td><td>7</td><td>8</td><td>9</td> </tr> <tr> <td>10</td><td>11</td><td>12</td><td>13</td><td>14</td><td>15</td><td>16</td> </tr> <tr> <td>17</td><td>18</td><td>19</td><td>20</td><td>21</td><td>22</td><td>23</td> </tr> <tr> <td>24</td><td>25</td><td>26</td><td>27</td><td>28</td><td>29</td><td>30</td> </tr> </tbody> </table> <p>Spring Semester classes Apr.12 to Jul.22</p>		mon	tue	wed	thu	fri	sat	sun						1	2	3	4	5	6	7	8	9	10	11	12	13	14	15	16	17	18	19	20	21	22	23	24	25	26	27	28	29	30	<p>1 Entrance Ceremony for new degree students</p> <p>1 Spring Semester begins</p> <p>3 Japanese placement test</p> <p>2~12 Spring Semester course registration (sophomores, juniors, seniors)</p> <p>2~7 "First Lottery" registration (sophomores, juniors, seniors)</p> <p>3~11 Medical check-up</p> <p>3~12 Spring Semester course registration (freshmen)</p> <p>3~7 "First Lottery" registration (freshmen)</p> <p>8 Results of "First Lottery" registration available on Loyola</p> <p>8~9 "Second Lottery" registration</p> <p>10 Results of "Second Lottery" registration available on Loyola</p> <p>10~12 "Final Lottery" registration (first-come-first-served basis)</p> <p>12 Spring Semester classes begin</p> <p>13 Results of course registration available on Loyola</p> <p>14~16 Course adjustment</p> <p>18 Final confirmation of course registration available on Loyola</p>
mon	tue	wed	thu	fri	sat	sun																																						
					1	2																																						
3	4	5	6	7	8	9																																						
10	11	12	13	14	15	16																																						
17	18	19	20	21	22	23																																						
24	25	26	27	28	29	30																																						
<p style="text-align: center;">May</p> <table border="1" style="width: 100%; text-align: center;"> <thead> <tr> <th>mon</th><th>tue</th><th>wed</th><th>thu</th><th>fri</th><th>sat</th><th>sun</th> </tr> </thead> <tbody> <tr> <td>1</td><td>2</td><td>3</td><td>4</td><td>5</td><td>6</td><td>7</td> </tr> <tr> <td>8</td><td>9</td><td>10</td><td>11</td><td>12</td><td>13</td><td>14</td> </tr> <tr> <td>15</td><td>16</td><td>17</td><td>18</td><td>19</td><td>20</td><td>21</td> </tr> <tr> <td>22</td><td>23</td><td>24</td><td>25</td><td>26</td><td>27</td><td>28</td> </tr> <tr> <td>29</td><td>30</td><td>31</td><td></td><td></td><td></td><td></td> </tr> </tbody> </table>		mon	tue	wed	thu	fri	sat	sun	1	2	3	4	5	6	7	8	9	10	11	12	13	14	15	16	17	18	19	20	21	22	23	24	25	26	27	28	29	30	31					<p>8~11 Withdrawal period for spring courses offered in the first half of the semester</p> <p>28 Sophian's day</p> <p>31 Leave of absence application deadline for Spring Semester</p>
mon	tue	wed	thu	fri	sat	sun																																						
1	2	3	4	5	6	7																																						
8	9	10	11	12	13	14																																						
15	16	17	18	19	20	21																																						
22	23	24	25	26	27	28																																						
29	30	31																																										
<p style="text-align: center;">June</p> <table border="1" style="width: 100%; text-align: center;"> <thead> <tr> <th>mon</th><th>tue</th><th>wed</th><th>thu</th><th>fri</th><th>sat</th><th>sun</th> </tr> </thead> <tbody> <tr> <td></td><td></td><td></td><td>1</td><td>2</td><td>3</td><td>4</td> </tr> <tr> <td>5</td><td>6</td><td>7</td><td>8</td><td>9</td><td>10</td><td>11</td> </tr> <tr> <td>12</td><td>13</td><td>14</td><td>15</td><td>16</td><td>17</td><td>18</td> </tr> <tr> <td>19</td><td>20</td><td>21</td><td>22</td><td>23</td><td>24</td><td>25</td> </tr> <tr> <td>26</td><td>27</td><td>28</td><td>29</td><td>30</td><td></td><td></td> </tr> </tbody> </table>		mon	tue	wed	thu	fri	sat	sun				1	2	3	4	5	6	7	8	9	10	11	12	13	14	15	16	17	18	19	20	21	22	23	24	25	26	27	28	29	30			<p>5~9 Withdrawal period</p> <p>17 · 25 Spring Semester Make-up Classes</p>
mon	tue	wed	thu	fri	sat	sun																																						
			1	2	3	4																																						
5	6	7	8	9	10	11																																						
12	13	14	15	16	17	18																																						
19	20	21	22	23	24	25																																						
26	27	28	29	30																																								

Calendar		Academic Calendar																																																	
☐ : Vacation, National holidays, Saturdays. ◐ : Offices closed on days other than national holidays □ : Virtual Day																																																			
July <table border="1"> <thead> <tr> <th>mon</th> <th>tue</th> <th>wed</th> <th>thu</th> <th>fri</th> <th>sat</th> <th>sun</th> </tr> </thead> <tbody> <tr> <td></td> <td></td> <td></td> <td></td> <td></td> <td>1</td> <td>2</td> </tr> <tr> <td>3</td> <td>4</td> <td>5</td> <td>6</td> <td>7</td> <td>8</td> <td>9</td> </tr> <tr> <td>10</td> <td>11</td> <td>12</td> <td>13</td> <td>14</td> <td>15</td> <td>16</td> </tr> <tr> <td>17</td> <td>18</td> <td>19</td> <td>20</td> <td>21</td> <td>22</td> <td>23</td> </tr> <tr> <td>24</td> <td>25</td> <td>26</td> <td>27</td> <td>28</td> <td>29</td> <td>30</td> </tr> <tr> <td>31</td> <td></td> <td></td> <td></td> <td></td> <td></td> <td></td> </tr> </tbody> </table> ※Summer vacation : July 31 to Sep 26 ※Classes are held on 17th, Marine Day		mon	tue	wed	thu	fri	sat	sun						1	2	3	4	5	6	7	8	9	10	11	12	13	14	15	16	17	18	19	20	21	22	23	24	25	26	27	28	29	30	31							1・15 Spring Semester Make-up Classes 10 Spring Semester final exam schedule available on Loyola 17 Class to be held on national holiday (Marine Day) 22 Spring Semester classes end 24~29 Spring Semester Final examinations period (Extra day: July 29) 31~ Summer Vacation (until Sep.26)
mon	tue	wed	thu	fri	sat	sun																																													
					1	2																																													
3	4	5	6	7	8	9																																													
10	11	12	13	14	15	16																																													
17	18	19	20	21	22	23																																													
24	25	26	27	28	29	30																																													
31																																																			
August <table border="1"> <thead> <tr> <th>mon</th> <th>tue</th> <th>wed</th> <th>thu</th> <th>fri</th> <th>sat</th> <th>sun</th> </tr> </thead> <tbody> <tr> <td></td> <td>1</td> <td>2</td> <td>3</td> <td>4</td> <td>5</td> <td>6</td> </tr> <tr> <td>7</td> <td>8</td> <td>9</td> <td>10</td> <td>11</td> <td>12</td> <td>13</td> </tr> <tr> <td>14</td> <td>15</td> <td>16</td> <td>17</td> <td>18</td> <td>19</td> <td>20</td> </tr> <tr> <td>21</td> <td>22</td> <td>23</td> <td>24</td> <td>25</td> <td>26</td> <td>27</td> </tr> <tr> <td>28</td> <td>29</td> <td>30</td> <td>31</td> <td></td> <td></td> <td></td> </tr> </tbody> </table> ※Summer vacation : July 31 to Sep 26		mon	tue	wed	thu	fri	sat	sun		1	2	3	4	5	6	7	8	9	10	11	12	13	14	15	16	17	18	19	20	21	22	23	24	25	26	27	28	29	30	31				Spring Semester Make-up Exams (end of August) 28 <Seniors and Graduating Students>Grades / Self-Evaluation available 28・29 <Seniors and Graduating Students>Spring Semester Request for Grade Review							
mon	tue	wed	thu	fri	sat	sun																																													
	1	2	3	4	5	6																																													
7	8	9	10	11	12	13																																													
14	15	16	17	18	19	20																																													
21	22	23	24	25	26	27																																													
28	29	30	31																																																
September <table border="1"> <thead> <tr> <th>mon</th> <th>tue</th> <th>wed</th> <th>thu</th> <th>fri</th> <th>sat</th> <th>sun</th> </tr> </thead> <tbody> <tr> <td></td> <td></td> <td></td> <td></td> <td>1</td> <td>2</td> <td>3</td> </tr> <tr> <td>4</td> <td>5</td> <td>6</td> <td>7</td> <td>8</td> <td>9</td> <td>10</td> </tr> <tr> <td>11</td> <td>12</td> <td>13</td> <td>14</td> <td>15</td> <td>16</td> <td>17</td> </tr> <tr> <td>18</td> <td>19</td> <td>20</td> <td>21</td> <td>22</td> <td>23</td> <td>24</td> </tr> <tr> <td>25</td> <td>26</td> <td>27</td> <td>28</td> <td>29</td> <td>30</td> <td></td> </tr> </tbody> </table> ※Summer vacation: July 31 to Sep. 26 Autumn Semester classes Sep 27 to Jan 22		mon	tue	wed	thu	fri	sat	sun					1	2	3	4	5	6	7	8	9	10	11	12	13	14	15	16	17	18	19	20	21	22	23	24	25	26	27	28	29	30		8 Announcement of graduating students on Loyola 9 <Juniors>Grades / Self-Evaluation available 10 <Sophomores>Grades / Self-Evaluation available 11 <Freshmen>Grades / Self-Evaluation available 15 Graduation ceremony 20 Spring Semester ends 20 Deadline for Request for Grade Review of 2017 Spring Semester courses 21 Autumn Semester begins 21 Entrance Ceremony, Orientation for new students 21~30 Autumn Semester course registration (sophomores, juniors, seniors) 21~25 "First Lottery" registration (sophomores, juniors, seniors) 22~30 Autumn Semester course registration (freshmen) 22~25 "First Lottery" registration (freshmen) 22 Japanese Placement Test 23・24 Orientation Camp (freshmen) 26 Results of "First Lottery" registration available on Loyola 26・27 "Second Lottery" registration 28 Results of "Second Lottery" registration available on Loyola 28~30 "Final Lottery" registration (first-come-first-served basis) 27 Autumn Semester classes begin							
mon	tue	wed	thu	fri	sat	sun																																													
				1	2	3																																													
4	5	6	7	8	9	10																																													
11	12	13	14	15	16	17																																													
18	19	20	21	22	23	24																																													
25	26	27	28	29	30																																														

Calendar		Academic Calendar																																																		
<p>○ : Vacation, National holidays, Saturdays. □ : Offices closed on days other than national holidays ◻ : Virtual Day</p>																																																				
<p>October</p> <table border="1"> <thead> <tr> <th>mon</th><th>tue</th><th>wed</th><th>thu</th><th>fri</th><th>sat</th><th>sun</th> </tr> </thead> <tbody> <tr> <td></td><td></td><td></td><td></td><td></td><td></td><td>1</td> </tr> <tr> <td>2</td><td>3</td><td>4</td><td>5</td><td>6</td><td>7</td><td>8</td> </tr> <tr> <td>9</td><td>10</td><td>11</td><td>12</td><td>13</td><td>14</td><td>15</td> </tr> <tr> <td>16</td><td>17</td><td>18</td><td>19</td><td>20</td><td>21</td><td>22</td> </tr> <tr> <td>23</td><td>24</td><td>25</td><td>26</td><td>27</td><td>28</td><td>29</td> </tr> <tr> <td>30</td><td>31</td><td></td><td></td><td></td><td></td><td></td> </tr> </tbody> </table> <p>※ Classes are held on 9th, Health Sports Day</p>		mon	tue	wed	thu	fri	sat	sun							1	2	3	4	5	6	7	8	9	10	11	12	13	14	15	16	17	18	19	20	21	22	23	24	25	26	27	28	29	30	31						<p>1・2 3~5 9 9 23~26</p>	<p>Results of course registration available on Loyola Course adjustment Final confirmation of course registration available on Loyola Class to be held on national holiday (Health Sports Day) Withdrawal period for Autumn courses offered in the first half of the semester</p>
mon	tue	wed	thu	fri	sat	sun																																														
						1																																														
2	3	4	5	6	7	8																																														
9	10	11	12	13	14	15																																														
16	17	18	19	20	21	22																																														
23	24	25	26	27	28	29																																														
30	31																																																			
<p>November</p> <table border="1"> <thead> <tr> <th>mon</th><th>tue</th><th>wed</th><th>thu</th><th>fri</th><th>sat</th><th>sun</th> </tr> </thead> <tbody> <tr> <td></td><td></td><td>1</td><td>2</td><td>3</td><td>4</td><td>5</td> </tr> <tr> <td>6</td><td>7</td><td>8</td><td>9</td><td>10</td><td>11</td><td>12</td> </tr> <tr> <td>13</td><td>14</td><td>15</td><td>16</td><td>17</td><td>18</td><td>19</td> </tr> <tr> <td>20</td><td>21</td><td>22</td><td>23</td><td>24</td><td>25</td><td>26</td> </tr> <tr> <td>27</td><td>28</td><td>29</td><td>30</td><td></td><td></td><td></td> </tr> </tbody> </table> <p>※ Classes are held on 23th, Labor Thanksgiving day</p>		mon	tue	wed	thu	fri	sat	sun			1	2	3	4	5	6	7	8	9	10	11	12	13	14	15	16	17	18	19	20	21	22	23	24	25	26	27	28	29	30				<p>1 2~4 2・4 23 30</p>	<p>Foundation Day・Memorial Service (No class day) Sophia Festival No class day Class to be held on national holiday (Labor Thanksgiving Day) Leave of absence application deadline for Autumn Semester</p>							
mon	tue	wed	thu	fri	sat	sun																																														
		1	2	3	4	5																																														
6	7	8	9	10	11	12																																														
13	14	15	16	17	18	19																																														
20	21	22	23	24	25	26																																														
27	28	29	30																																																	
<p>December</p> <table border="1"> <thead> <tr> <th>mon</th><th>tue</th><th>wed</th><th>thu</th><th>fri</th><th>sat</th><th>sun</th> </tr> </thead> <tbody> <tr> <td></td><td></td><td></td><td></td><td>1</td><td>2</td><td>3</td> </tr> <tr> <td>4</td><td>5</td><td>6</td><td>7</td><td>8</td><td>9</td><td>10</td> </tr> <tr> <td>11</td><td>12</td><td>13</td><td>14</td><td>15</td><td>16</td><td>17</td> </tr> <tr> <td>18</td><td>19</td><td>20</td><td>21</td><td>22</td><td>23</td><td>24</td> </tr> <tr> <td>25</td><td>26</td><td>27</td><td>28</td><td>29</td><td>30</td><td>31</td> </tr> </tbody> </table> <p>※ Winter Recess : Dec 22~Jan 4</p>		mon	tue	wed	thu	fri	sat	sun					1	2	3	4	5	6	7	8	9	10	11	12	13	14	15	16	17	18	19	20	21	22	23	24	25	26	27	28	29	30	31	<p>3 4~8 9・16 21 22~</p>	<p>St. Xavier's Day (No class day) Withdrawal period Autumn Semester Make-up class Classes end Winter Recess (until Jan 4)</p>							
mon	tue	wed	thu	fri	sat	sun																																														
				1	2	3																																														
4	5	6	7	8	9	10																																														
11	12	13	14	15	16	17																																														
18	19	20	21	22	23	24																																														
25	26	27	28	29	30	31																																														

Calendar ◐ : Vacation, National holidays, Saturdays. ◑ : Offices closed on days other than national holidays □ : Virtual Day		Academic Calendar																																																		
2018 <table border="1"> <thead> <tr> <th colspan="7">January</th> </tr> <tr> <th>mon</th><th>tue</th><th>wed</th><th>thu</th><th>fri</th><th>sat</th><th>sun</th> </tr> </thead> <tbody> <tr> <td>1</td><td>2</td><td>3</td><td>4</td><td>5</td><td>6</td><td>7</td> </tr> <tr> <td>8</td><td>9</td><td>10</td><td>11</td><td>12</td><td>13</td><td>14</td> </tr> <tr> <td>15</td><td>16</td><td>17</td><td>18</td><td>19</td><td>20</td><td>21</td> </tr> <tr> <td>22</td><td>23</td><td>24</td><td>25</td><td>26</td><td>27</td><td>28</td> </tr> <tr> <td>29</td><td>30</td><td>31</td><td></td><td></td><td></td><td></td> </tr> </tbody> </table> ※ Winter Recess : Dec 22~Jan 4 ※ Spring Vacation : Jan 31~Mar 31		January							mon	tue	wed	thu	fri	sat	sun	1	2	3	4	5	6	7	8	9	10	11	12	13	14	15	16	17	18	19	20	21	22	23	24	25	26	27	28	29	30	31					5 6 · 13 9 22 23~30 31	Autumn Semester classes resume Autumn Semester Make-up Classes Autumn Semester Final Exams schedule available on Loyola Autumn Semester classes end Autumn Semester Final Examinations Period (Extra day: Jan.30) Spring vacation (until Mar.31)
January																																																				
mon	tue	wed	thu	fri	sat	sun																																														
1	2	3	4	5	6	7																																														
8	9	10	11	12	13	14																																														
15	16	17	18	19	20	21																																														
22	23	24	25	26	27	28																																														
29	30	31																																																		
<table border="1"> <thead> <tr> <th colspan="7">February</th> </tr> <tr> <th>mon</th><th>tue</th><th>wed</th><th>thu</th><th>fri</th><th>sat</th><th>sun</th> </tr> </thead> <tbody> <tr> <td></td><td></td><td></td><td>1</td><td>2</td><td>3</td><td>4</td> </tr> <tr> <td>5</td><td>6</td><td>7</td><td>8</td><td>9</td><td>10</td><td>11</td> </tr> <tr> <td>12</td><td>13</td><td>14</td><td>15</td><td>16</td><td>17</td><td>18</td> </tr> <tr> <td>19</td><td>20</td><td>21</td><td>22</td><td>23</td><td>24</td><td>25</td> </tr> <tr> <td>26</td><td>27</td><td>28</td><td></td><td></td><td></td><td></td> </tr> </tbody> </table> ※ Spring Vacation : Jan 31~Mar 31		February							mon	tue	wed	thu	fri	sat	sun				1	2	3	4	5	6	7	8	9	10	11	12	13	14	15	16	17	18	19	20	21	22	23	24	25	26	27	28					23 23~27	Autumn Semester Make-up Exams (mid to end of Feb) <Seniors and graduating students> Grades / Self-Evaluation available <Graduating Students> 2017 Autumn Semester "Request for Grade Review"
February																																																				
mon	tue	wed	thu	fri	sat	sun																																														
			1	2	3	4																																														
5	6	7	8	9	10	11																																														
12	13	14	15	16	17	18																																														
19	20	21	22	23	24	25																																														
26	27	28																																																		
<table border="1"> <thead> <tr> <th colspan="7">March</th> </tr> <tr> <th>mon</th><th>tue</th><th>wed</th><th>thu</th><th>fri</th><th>sat</th><th>sun</th> </tr> </thead> <tbody> <tr> <td></td><td></td><td></td><td>1</td><td>2</td><td>3</td><td>4</td> </tr> <tr> <td>5</td><td>6</td><td>7</td><td>8</td><td>9</td><td>10</td><td>11</td> </tr> <tr> <td>12</td><td>13</td><td>14</td><td>15</td><td>16</td><td>17</td><td>18</td> </tr> <tr> <td>19</td><td>20</td><td>21</td><td>22</td><td>23</td><td>24</td><td>25</td> </tr> <tr> <td>26</td><td>27</td><td>28</td><td>29</td><td>30</td><td>31</td><td></td> </tr> </tbody> </table> ※ Spring Vacation : Jan 31~Mar 31		March							mon	tue	wed	thu	fri	sat	sun				1	2	3	4	5	6	7	8	9	10	11	12	13	14	15	16	17	18	19	20	21	22	23	24	25	26	27	28	29	30	31		15 16 17 18 26 30 31	Announcement of graduating students on Loyola <Juniors> Grades / Self-Evaluation available <Sophomores> Grades / Self-Evaluation available <Freshmen> Grades / Self-Evaluation available Graduation Ceremony Deadline for "Request for Grade Review" for 2017 Autumn Semester courses Autumn Semester ends
March																																																				
mon	tue	wed	thu	fri	sat	sun																																														
			1	2	3	4																																														
5	6	7	8	9	10	11																																														
12	13	14	15	16	17	18																																														
19	20	21	22	23	24	25																																														
26	27	28	29	30	31																																															

● Frequently Asked Questions

Q Which offices should I go to with my questions?

A The following list shows offices and their services. For the locations of offices, see p.14

Information and advice on course enrollment, grades, classes, credits, examination, Loyola passwords	Center for Academic Affairs (Academic Services) (1st floor, Bldg. No.2)
Certificates, Student ID Cards, change of address, tuition and fees	Center for Academic Affairs (Academic Records) (1st floor, Bldg. No.2)
Clubs/circles, part-time jobs, volunteer activities, extracurricular activities, scholarships, accommodations, dormitory, insurance, nursery, prayer room, assistance for students with disabilities	Center for Student Affairs (1st floor, Bldg. No.2)
Student exchange programs, overseas short-term programs, counseling for study abroad, study abroad insurance	Center for Global Discovery (1st floor, Bldg. No.2)
Global Competency Program, Internship Courses, Sophia Short-term Programs	Center for Global Discovery (1 st basement floor, Bldg. No.2)
Teaching licenses, curator license courses	Center for Teaching & Curator Credentials (1st floor, Bldg. No.2)
PC Login password, how to use Sophia Mail, Moodle, Printer and network	Media Center / Consultation Room (3rd floor, Bldg. No.2) Media Center Web site -> 'Center Guide' http://ccweb.cc.sophia.ac.jp
Lost and found	Office of Property (1st floor, Bldg. No.2)
Job search activities, internship, seminars	Career Center (1st floor, Bldg. No.2)
First aid, health consultation, medical exam certificate	Health Center (2nd floor, Hoffmann Hall) (in front of Bldg. No11 entrance)
Problems and difficulties of student life and mental health concerns	Counseling Center (3rd floor, Bldg. No.10)

Q How should I contact my teachers?

A Check the faculty status of your teacher, full-time or part-time, on the List of Instructors (Academic Handbook 履修要覧 Bulletin of Information). Names marked with an asterisk “*” are part-time lecturers. See p.16 for detail.

Q Where and when can I get information and advice on course enrollment?

A Academic Services of the Center for Academic Affairs provide information and advice on course enrollment (no telephone inquiries about course enrollment, grades, credits etc. are accepted). Please visit the office during the office hours on weekdays, 9:30 to 11:30, 12:30 to 17:00.

Q I went to the classroom listed on the timetable, but a different class was in session.

A The classroom may have been changed. Check the updated classroom information on Loyola, under “Class Bulletin Board” and “Course Schedule”.

Q The class period has started, but the instructor is not in the classroom; what should I do?

A First, check on Loyola for cancelled classes.

If your class is not on the list of cancelled classes and the instructor does not come to class 30 minutes past the scheduled starting time, please notify the Center for Academic Affairs and follow their instructions.

Q I have to be absent from class for family bereavement; is there a notice for authorized absence I should hand in?

A Sophia University does not have a system for authorized absence from class or notices of pre-approved absence.

If you were absent from class for unavoidable reasons, please see your class instructor in person and explain the situation. The Center for Academic Affairs cannot relay your message of absence from class. When you return to the university, contact the teachers of the courses you are taking (if you were absent because of infectious diseases, see p.20). If you were absent during the Final Exams period, you may be allowed to take a make-up exam (p.33~).

Q I want to know the schedule of university holidays and final exams, etc.

A Please refer to the 2017 Calendar for the Academic Year (p.8~)

● Office to visit for inquiries

The following list shows the various sections of the Center for Academic Affairs and their services:

Inquiries on:	Section/desk numbers
Teacher's license, curator certification program	Center for Teaching and Curator Credentials desk No.①
Course registration, grades, classes, credits	Center for Academic Affairs (Academic Services) No.② sections for each Department
Certificates, Student ID Card, change of address, leave of absence, study abroad etc.	Center for Academic Affairs (Academic Records) No.③~④
Tuition and fees	Center for Academic Affairs (Tuition & fees) No.⑤

(※) In general, students should visit the offices for inquiries; telephone inquiries are not accepted, especially inquiries regarding course enrollment, grades etc.

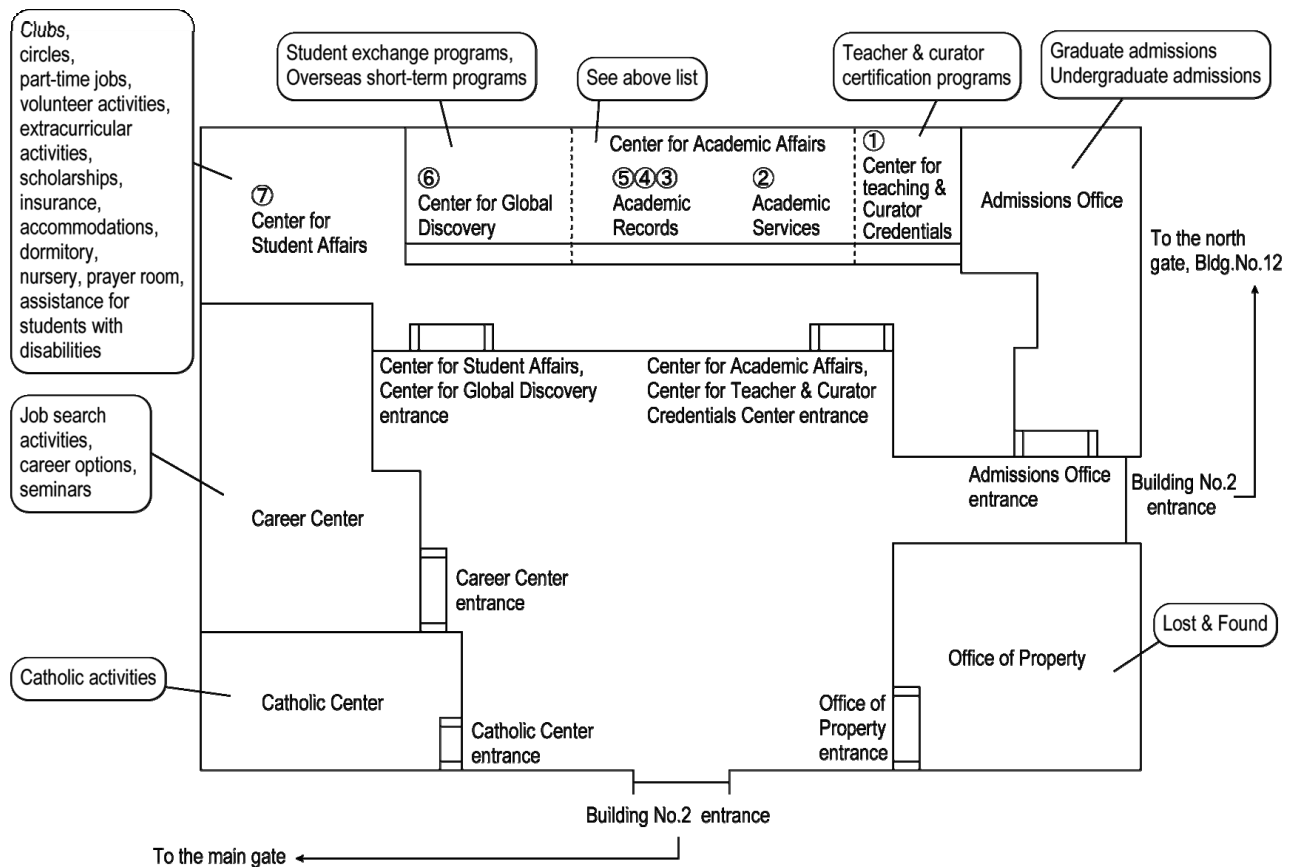

● Office Hours

Mon.- Fri.	Morning 9 : 30~11 : 30	Afternoon 12 : 30~17 : 00
------------	-------------------------------	----------------------------------

- ※ Services are available only during the above office hours for providing information and accepting applications and required documents.
- ※ Offices are closed on Saturdays, Sundays and national holidays.
- ※ Office hours during summer and winter vacations and in special cases are announced on the Loyola Bulletin Board for the Center for Academic Affairs (Academic Services).

● Announcements and Notices on Loyola

All announcements from the university to students will be posted via internet on the Loyola Bulletin Board. Any disadvantages that may arise from failure to check the Loyola Bulletin Board are the responsibility of individual students.

All announcements on class information (cancelled classes, make-up classes, temporary change of classrooms, notices on exams and reports), messages to individual students and important urgent notices are posted on Loyola.

Please check the Loyola Bulletin Board everyday for updated information from the university. The University may also post written announcements at the bulletin boards located on Yotsuya Campus. Please check the campus bulletin board locations on the end sheet.

<Loyola Bulletin Board> Important announcements are posted here; check every day!

Bulletin Boards	Information posted
Class Bulletin Board	Change of classrooms, notices from class teachers ※For cancelled classes, make-up classes, see “Bulletin Board (Cancel & Make up class/ Classroom Changes) →Cancel/ Make-up classes/ Temporary Changes of Classroom Inquiry” Students can only check information on the courses they registered for.
Individual notices	Messages to individual students from various offices; if paged, respond immediately
University Bulletin Board	Information on events related to Sophia; announcements from the university
Faculty and department office	Announcements from each Department /Program
Bulletin Board for Center for Academic Affairs (Academic Services)	Important announcements on course registration, changes of curriculum etc.
Bulletin Board for Center for Academic Affairs (Academic Records, Tuition)	Announcements regarding academic records, tuition and fees, certificates etc.

<Other information available on Loyola>

Information	Menu for inquiries
Check my classroom	Curriculum, Course Registration Info → Course Schedule → Inquiry on Course Schedule (Undergraduate)
Check for cancelled classes, make-up classes, temporary change of classrooms	Bulletin Board (Cancel & Make up class/ Classroom Changes) →Cancel/ Make-up classes/ Temporary Changes of Classroom Inquiry
Check the syllabus	Curriculum, Course Registration Info →Syllabus Inquiry
Register for courses; check the data I entered for course registration	Curriculum, Course Registration Info →Course registration — Course Registration, status of course registration Inquiry
Check my grades	Grades →Grade Inquiry
Use self-evaluation function	Grades →Self Evaluation
Check Final Exam schedule, report assignments	Final Exams →Final Exams Timetable Inquiry (for students)
Learn various functions of Loyola and how to operate them.	HOME →Loyola Handbook (for students)

● Guidance programs

At university, students are expected to decide on and to plan their own studies. There are various guidance programs held at the beginning of the semester to help them in course selection, registration and to give information on curriculum contents and study activities. Be sure to attend these. The following are the main guidance programs:

Students	Should attend these guidance programs:
First year students	New students guidance
Second year students and above	Current students guidance
Students intending to take teaching license course	Teaching license course orientation (April) Guidance session for new students of teaching license course (September)
Intending to take curator license course	Guidance session for new students of curator license course

Additional guidance programs may be offered as necessary; date and time of each program will be announced on Loyola.

● How to contact your teachers

The class teachers are either full-time faculty of Sophia or part-time lecturers from other universities coming to teach a particular course. The procedures for contacting teacher differ depending on whether they are full-time or part-time:

■ Full-time faculty:

Full time faculty have offices on campus and individual office hours for student appointments. If you need to make an appointment outside of office hours, contact your Department office for instructions.

Also, there are class advisors for each undergraduate class or seminar. The students may seek their advice on studies, course enrollment, career options and any difficulties in student life.

• List of teachers' offices and their office hours	:	Bulletin of Information, Academic Handbook (履修要覧)
• Other Department offices	:	Academic Handbook (履修要覧)
• List of principal class teachers of Departments	:	Bulletin of Information

■ Part-time lecturers

Part-time lecturers do not have offices on campus; contact them before or after classes. Some teachers may release their personal e-mail addresses to students.

Information on whether or not a teacher releases his/her contact information is available at the Center for Academic Affairs (Academic Services). Students should bring their Student ID Cards and inquire in person.

For the protection of personal information, the office does not accept telephone inquiries.

The Center for Academic Affairs does not relay messages from students to their teachers.

■ If you do not know whether the teacher you wish to contact is full-time or part-time teacher:

Please check the list of courses with names of class teachers (履修要覧) to see whether the teacher is full-time or part-time.

The teachers with an asterisk "*" in front of their names are part-time lecturers; those without an asterisk are full-time faculty.

● Change of address

If there are any changes in address of the student or the guarantor, either enter data on Loyola from the "Change of address of students" menu.

If there is a change in address of a guarantor residing abroad, please submit the "Change of address" form to the Center; you cannot make the change on Loyola.

If there is a change in address of the student, receive a new "enrollment sticker" from the Center and paste it on the back of your Student ID Card.

● When public transport service is shut down

When public transport services are shut down due to natural disasters such as typhoons and heavy rainfall or due to accidents or strikes and it is difficult to hold classes or final exams, special measures will be taken to cancel classes or change exam schedules. The special measures will be announced on the official university website, Loyola, the official Facebook or the official Twitter page; the students are responsible for checking the websites for information.

● Protection of Personal Information

For Sophia School Corporation's policy on the protection of personal information, visit the following site:

http://www.sophia.ac.jp/jpn/info/privacypolicy/joho_toriatsukai

Academic Services

(Course Registration/ Grades/Classes)

1. Courses ... P. 18

Duration of Course / Duration of Semester/
Class Hours / “Virtual Days” / Classes on
National Holidays / Classrooms/ Textbooks/
Class Cancellation/Make-up Classes/Absence
from Class/ Infectious Diseases/ Absence from
Class due to Selection as Lay Judge

2. Credits and Courses ...P. 21

Credits/Course Composition/ Course Types

3. Numbering ...P. 22

4. Course Registration ...P. 24

Course Registration Schedule/ Course
Registration / Limits on Number of Credits per
Semester(or Year)/ Repetition of Courses/
Lottery Courses/ Points to note on Course
Registration

5. Enrollment in Courses Offered by Faculty of Liberal Arts ...P. 29

Application Procedure for Course Enrollment/
Summer Session in Asian Studies

6. Course Withdrawal ... P. 30

Withdrawal from Courses/
Points to note on Course Withdrawal/
Request by “Course Withdrawal Request” Forms

7. Examinations ...P. 32

Types of exam/ Announcement of Schedule of
Final Exams (written tests)/ Report Exams/ Final
Exams (written tests) Policy/ Cheating in Final
Exams (written tests) is forbidden/ If public
transport service is shut down/ Make-up Exams/

Cheating in Report Exams is forbidden/ Stance
on Exams, Reports, Papers.

8. Evaluation / Grades ...P. 38

Evaluation Criteria/ GPA/ Grades Release
Dates/ Request for Grade Review/Guidance for
the Students whose GPA is less than
0.5/Students
with no prospect of academic progress

9. Graduation Requirements and Self Evaluation/Change of Category ...P. 41

Graduation Requirements/
Check credits required for graduation/
How to check Credits Required for Graduation/
Abolition of “Change of Category” on Loyola

10. Credit Transfer and Approval ...P. 43

Credit Transfer and Approval/
Grades of Courses with Transferred Credits/
Application Period for Credit Transfer and
Approval/ Transfer of Pre-matriculation Credits/
Credit Transfer of Transfer Students/
Credit Transfer for Teacher Certification
Program/ System of Graduate School
Pre-admission Course Enrollment/ Credit
Transfer by Student Exchange Agreement/
Credit Transfer from Study Abroad/

11. Overseas Short-term Language Programs/Short-term Study Abroad Programs/ Social Engagement programs ...P. 46

Credit Transfer of Overseas Short-term
Language Program/ Credit Transfer of
Overseas Short-term Study Abroad Program/
Credit Transfer of Social Engagement Programs
and Intensive courses

1. Courses

● Duration of Course

The duration of a course in one academic year is basically 35 weeks including the final exam period. For the first and last dates of courses and the final exam period, please see the 2017 Calendar for the Academic Year (p.8~).

● Duration of Semester

The duration of semesters is as follows:

Spring Semester: April 1 to September 20

Autumn Semester: September 21 to March 31

● Class Hours

Class period	Hours
0	8 : 15 ~ 9 : 00
1	9 : 15 ~ 10 : 45
2	11 : 00 ~ 12 : 30
3	13 : 30 ~ 15 : 00
4	15 : 15 ~ 16 : 45
5	17 : 00 ~ 18 : 30
6	18 : 45 ~ 20 : 15

※ Exceptions to the above regular class days and hours are Intensive Courses held on Saturdays, vacations, Sundays or during make-up class periods. The dates, hours and classrooms for these courses are announced on the Loyola Bulletin Board (Academic Services) or “Class Bulletin Board”. (These courses are listed on the Course Schedule as “Intensive Courses”).

● “Virtual Days”

“Virtual Days” are scheduled to make up for classes with an insufficient number of classes due to falling on certain days of the week of national holidays; classes are held on a day of the week different from that of the original schedule.

There is no “Virtual Days” in the Academic Year 2017.

● Classes on National Holidays

Classes may be held on national holidays to ensure that sufficient numbers of classes are held. For classes of the 2017 Academic Year held on national holidays, please see the 2017 Calendar for the Academic Year (p. 8~).

● Classrooms

Classes are generally held in the classrooms shown on Loyola. However, there may be changes in classrooms, temporary and for the whole semester due to the number of attending students or installed equipment. At the beginning of a semester, there may be frequent classroom changes. Please make it a habit of checking the classroom on Loyola before you go to your classes.

- Changes of classrooms for the whole semester
The new classrooms and the dates of changes will be posted on the Loyola Class Bulletin Board. Please also check the changes on Loyola under “Curriculum / Course Registration” → “Course Schedule” or “Bulletin board / Cancel & Make-up Classes” → “Class cancellation & Make-up Class”.
- Temporary changes of classrooms
Please check on Loyola under “Cancel & Make-up class”

● Textbooks

The textbooks necessary for classes and reference books will be listed on Loyola under “Curriculum Course Registration Info→Syllabus Inquiry”. If you are not required to have them prepared before classes start, follow the instructions of the teacher of the first day of class.

At the beginning of the semester, the textbooks and reference book order are available through the Kinokuniya website. For details, please see the Loyola Bulletin Board(Academic Services).

● Class Cancellation

If a class teacher cannot hold classes for reasons such as official duties, official trips, academic meetings, or illness, the classes may be cancelled. Information on class cancellation will be announced on Loyola when the class teacher notifies the office. However, under unavoidable circumstances we may have to announce the cancellation on the day of the class, so please make sure to check Loyola before you go to your classes every day.

If your class is not on the cancelled class list on Loyola but the teacher does not appear in class 30 minutes after the scheduled starting time, please notify the Center for Academic Affairs and follow their instructions.

● Make-up Classes

Make-up classes are normally held on predetermined dates scheduled in the Spring and Autumn Semesters, but they may be held on other days. In both cases, the classroom, date and time of make-up classes will be announced on Loyola. Please check Loyola before you attend the make-up class.

For 2017 Make-up classes, check the 2017 Calendar for the Academic Year (p.8~). Note that the make-up classes are held in the same manner as regular classes as they are intended to make up for classes that were cancelled.

● Absence from Class

Sophia University does not have a system for authorized absence from class or making notice of pre-approved absence. The Center for Academic Affairs cannot relay your message of absence. If you were absent from class due to unavoidable reasons such as bereavement, delay in public transport service, illness, extracurricular activities, or job searching, you need to see your class teacher in person and explain the situation. However, if you are absent during the Final Exams period, you may be allowed to take a make-up exam (p.33~).

If you need to be absent for a long period of time due to illness or injury, consult the Department Chairperson or your class advisor (p. 90~).

● Infectious Diseases

When students contract an infectious disease as defined by the School Health and Safety Act, the students are not allowed to come to school for a certain period of time to prevent the spread of the disease. Should you contract such a disease, take the following steps:

If students contract a new infectious disease such as a new strain of influenza, special measures may be taken; please check announcements on Loyola and the official university website.

1. You must follow your physician's instructions and stay home until there is no risk of infection. Please notify the university Health Center of your situation by phone, fax (download the report form from the official university website) or Loyola.
2. Download the "Doctor's permission to return to campus (Toko Kyoka Sho)" (感染症治癒後登校許可証明書) from the official university website and have it filled out by your physician (a form from any medical organization may be used if it states the period the student is not allowed to go to school).
 - ※ If you cannot download the form, ask for the form at the Health Center.
3. When you return to school, submit the above original certificate to the Health Center and photocopies to each of your class teachers.
 - ※ For absence during the final exam period, refer to "Make-up exams" on p. 33.

● Absence from Class due to Selection as Lay Judge

The lay judge system introduced in recent years according to "Act on Criminal Trials Examined under Lay Judge System" allows students to decline to serve as lay judges. However, to respect the intentions of students selected wishing to serve as lay judges, students may serve through the following procedures:

1. Students who may apply:
Full-time undergraduate or graduate degree students of Sophia University and non-matriculated students (excluding auditing students).
 2. Reasons justified for applying
 - 1) Appearing at a courthouse as a lay judge candidate for appointment procedures
 - 2) Attending a trial as a lay judge
 - 3) To attend a court as an alternate lay judge member
 3. Procedures
In general, students must contact the Center for Academic Affairs, receive a copy of the designated Notification of Absence due to Lay Judge Service form, and submit this form, along with a copy of the Notice of Date for Lay Judge Appointment sent in the mail from the court, to the faculty member(s) in charge of the class(es) from which the student is to be absent. The student must also show to the faculty member(s) the post-trial discharge certification documentation issued by the court.
 4. Absence from class
When the student follows the above procedures, the teacher will process the absence as follows so that the student will not be at a disadvantage.
 - 1) Classes: the student will not be considered "absent"; providing any alternative measures will be at the discretion of the teacher.
 - 2) In-class exam: the student will not be considered "absent"; providing any alternative measures will be at the discretion of the teacher.
 - 3) Final exams: the student may take a make-up exam; the student must follow the usual procedures and submit a request for make-up exam by the deadline (p. 33~).
- * For reference:
Students are eligible to be selected as lay judge candidates but the law defines that they may decline to serve. The possible options related to court appearance are as follows:
(Options for students)
- a) A student may follow the lay judge selection procedures and participate in court as a lay judge.
 - b) A student may decline to serve because you have the student status.
 - c) A student may decline to serve if summoned during the final exam period or any other specific month or day.
- (Reasons justified for declining to serve)
- You have a reason for declining to serve justified for the whole year--namely your "student" status.
 - You have a specific month in which it is extremely difficult to serve as a lay judge; during final exams.
 - You have an important service in social life that cannot be performed on any other date.

2. Credits and Courses

● Credits

A certain number of credits are given for all courses; if you take the courses and pass the exams, you will earn the credits. The calculation method of credits varies depending on the type of course. The numbers of credits you may earn for the courses you register for are given in the “Bulletin of Information” in the sections for each Department or the sections of *Zengaku Kyotsu Kamoku* (General Studies courses) with lists of instructors.

The number of credits required for graduation varies depending on the Department and Matriculation Year. You must check the requirements on the sections of your Department “1. Courses and minimum number of credits required for graduation”, “2. Standard course distribution list”.

Based on government requirements of Standards for Establishment of Universities and Article 22 of Sophia University Regulations, “45 hours of study is required to earn one course credit”. This means that students are required to study a number of hours other than the actual class hours.

● Course Composition

【For students who entered from 2014】

Courses are divided into three main groups; General Studies (*Zengaku-Kyotsu-Kamoku*) courses offered by all Faculties, Language Courses offered by the Center for Language Education and Research and Specialized Education courses offered by each Department.

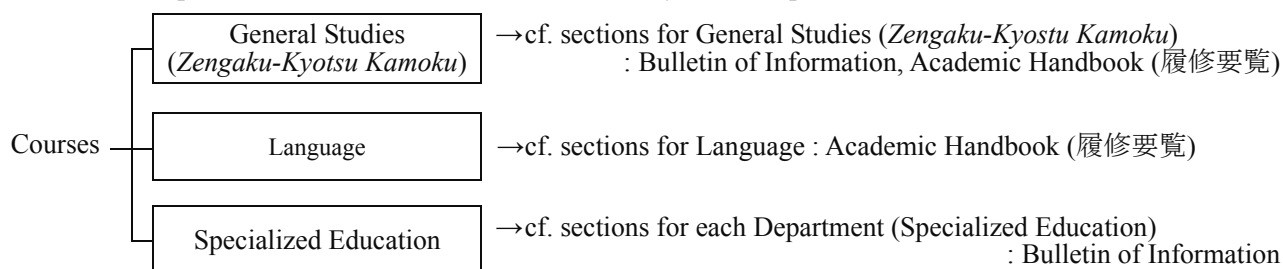

【For students who entered before 2013】

Courses are divided into two main groups; General Studies (*Zengaku-Kyotsu-Kamoku*) courses offered by all Faculties and Specialized Education courses offered by each Department.

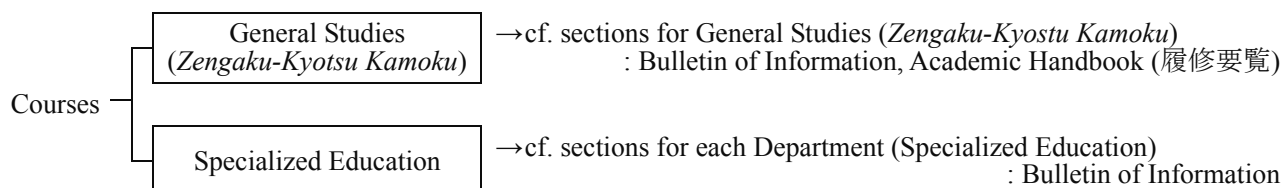

● Course Types

General Studies (*Zengaku-Kyotsu Kamoku*) and Specialized Education are divided into four categories

Compulsory courses	You must take these courses
Elective Compulsory	You may choose from several courses in this category to meet the credit requirements set by each Department
Electives	You may select the courses
Optional courses	You may take courses that interest you academically or personally (credits will not be counted into graduation requirements)

The credit requirements vary by Department. For more details see the sections for your Department in “1. Courses and minimum number of credits required for graduation” and “2. Standard course distribution list”

3. Numbering

The Numbering system has been introduced for all Faculties from Academic Year 2014.

Numbering is a system that classifies courses by giving appropriate numbers to show the level and order of learning and clearly indicates the curriculum system.

Numbering shows the fields of the course subject, the levels of learning, and the order in which courses should be taken. The Numbering system will be a useful guide to help students in planning course enrollment.

- 1) Courses to which Numbering applies: All undergraduate courses
Courses offered by all Faculties
- 2) Basic policy of Numbering

↓ Shows the field of course subject (given three alphabet letters)

A A A 1 1 1

↑ The hundreds place shows the level of learning of the course

【The levels classified by the hundreds place】

100's: Introductory level courses

200's: Courses that lead from the Basic to Specialized level

300's: Specialized level or courses for specialized knowledge that connects to society

400's: Courses for specialized areas (advanced levels, seminars in specialized area)

- The numbering policy of each Department is given on the pages for each Department in the points to note for course enrollment.

- 3) The numbering is shown in the column next to the course code on the List of Courses and Instructors.

※ Sample

Course code	Numbering	Course title	Credit	Semester	Instructor	Year in school	Remarks
BGS50100	GBG200	グローバル化と政治学	2	Spring	岸 川 毅	1・2	[190]
BGS50200	GBG201	グローバル化と経済学 1	2	Spring	* 東 三 鈴	1・2	[190]
BGS50201	GBG202	グローバル化と経済学 2	2	Autumn	* 東 三 鈴	1・2	[190]

Field (alphabet)	Field
NSC	NATURAL SCIENCE
MTH	MATHEMATICS
PHY	PHYSICS
CHM	CHEMISTRY
BIO	BIOLOGY
INF	INFORMATICS
EEE	ELECTRICAL
MEC	MECHANICAL ENGINEERING
EAS	ENGINEERING AND APPLIED SCIENCES
MLS	MATERIAL AND SCIENCES
ICS	INFORMATION AND COMMUNICATION SCIENCES
GEL	GEOLOGY

4. Course Registration

● Course Registration Schedule

Students must register for courses for spring and autumn Semesters on Loyola during the period set for course registration.

More information on procedures of Loyola and points to be noted about course registration are given in the “Loyola Handbook” online. Read it thoroughly to avoid registration errors.

■ Schedule for 2017 Spring Semester Course Registration

	Academic event	Year level	Period	Notes
①	Self evaluation	all students	April 1 (Sat) 10:00~	May use self-evaluation function
②	Course registration (Spring Semester)	2nd, 3rd, 4th year	April 2 (Sun) 10 : 00 ~ April 12 (Wed) by 21 : 00	To enroll in Spring Semester (except for lottery courses) you must register during this period on Loyola.
		1st year	April 3 (Mon) 10 : 00 ~ April 12 (Wed) by 21 : 00	
③	Lottery course registration (First)	2nd, 3rd, 4th year	April 2 (Sun) 10 : 00 ~ April 7 (Fri) by 15 : 00	To enroll in Spring Semester lottery courses , you must submit your entries for lottery courses during this period on Loyola.
		1st year	April 3 (Mon) 10 : 00 ~ April 7 (Fri) by 15 : 00	
④	Results of lottery course registration (First)	all students	April 8 (Sat) 13 : 00~	May check lottery results of courses you entered for in period ③
⑤	Lottery course registration (Second)	all students	April 8 (Sat) 13 : 00~ April 9 (Sun) by 15 : 00	May submit your entries for courses that did not reach capacity in the first lottery
⑥	Results of lottery course registration (Second)	all students	April 10 (Mon) 13 : 00~	May check the lottery results of pre-registered courses (registered for in period ⑤) on Loyola
⑦	Lottery course registration ※First-come-first-served basis	all students	April 10(Mon) 13 : 00~ April 12(Wed) by 21 : 00	May make entries on Loyola, on a first-come-first-served basis, for courses that did not reach capacity in the first and second lotteries.
⑧	Results of course registration available	all students	April 13(Thu)	May check results of course registration (registered for in periods ②, ③, ⑤, and ⑦) on Loyola
⑨	Course adjustment	all students	April 14 (Fri) 10 : 00~ April 16 (Sun) by 21 : 00	May make adjustments to results of course registration on Loyola
⑩	Final confirmation of course registration (Spring Semester final results)	all students	April 18 (Tue) 13 : 00~	Check results of course adjustments (made in periods ②, ③, ⑤, ⑦, and ⑨) on Loyola

■ Schedule for 2017 Autumn Semester course registration

	Academic event	Year level	Period	Notes
①	Self evaluation	All students except those in the 1 st semester	Sept 11 (Mon) 10:00~	May use self-evaluation function
②	Course registration (Autumn Semester)	2nd, 3rd, 4th year	Sept 21 (Thu) 10 : 00~ Sept 30 (Sat) by 21 : 00	To enroll in Autumn Semester courses (except for lottery courses) you must register during this period on Loyola.
		1st year	Sept 22 (Fri) 10:00~ Sept 30 (Sat) by 21:00	
③	Lottery course registration (First)	2nd, 3rd, 4th year	Sept 21 (Thu) 10 : 00~ Sept 25 (Mon) by 15 : 00	To enroll in Autumn Semester lottery courses, you must submit your entries for lottery courses during this period on Loyola. In the second lottery course registration period, you cannot make entries for courses that reached capacity in the first lottery.
		1st year	Sept 22 (Fri) 10 : 00~ Sept 25 (Mon) by 15 : 00	
④	Results of lottery course registration (First)	all students	Sept 26 (Tue) 13 : 00~	May check lottery results of courses you entered for in period ③
⑤	Lottery course registration (Second)	all students	Sept 26 (Tue) 13 : 00~ Sept 27 (Wed) by 15 : 00	May make your entries for courses that did not reach capacity in the first lottery
⑥	Results of lottery course registration (Second)	all students	Sept 28 (Thu) 13 : 00~	May check the lottery results of pre-registered courses (registered for in period ⑤) on Loyola
⑦	Lottery course registration ※First-come-first-served basis	all students	Sept 28 (Thu) 13 : 00~ Sept 30 (Sat) by 21 : 00	May submit entries on Loyola, on a first-come-first-served basis, for courses that did not reach capacity following first and second lotteries.

	Academic event	Year level	Period	Notes
⑧	Results of course registration available	all students	Oct 1(Sun) Oct 2 (Mon)	May check results of course registration (registered for in periods ②, ③, ⑤, and ⑦) on Loyola
⑨	Self evaluation	students in the 1st semester	Oct 1 (Sun) 10 : 00~	May use self-evaluation function
⑩	Course adjustment	all students	Oct 3 (Tue) 10 : 00~ Oct 5(Thu) by 21 : 00	May make adjustments to results of course registration on Loyola
⑪	Final confirmation of course registration (Autumn Semester final results)	all students	Oct 9 (Mon) 13 : 00~	May check results of course adjustments (made in periods ②, ③, ⑤, ⑦, and ⑩) on Loyola

● Course Registration

Course registration is the procedure for students to select the courses they intend to take (attend) and register for the courses within a given period. There are two separate course registration periods for lottery courses and non-lottery courses (for registration periods, see p. 24).

If you make registration errors, you will not be allowed to take the courses you intended to and no grades or credits will be given; take extra caution when registering for courses. Please read the “[Loyola Handbook](#)” on Loyola thoroughly before registering.

To avoid registration errors, log in to Loyola again after the registration has been completed and check that all courses you wish to take are registered. It is recommend that students print out or save a copy of the registration screen.

Any notices or announcements on course registration will be posted on the Loyola Bulletin Board (Academic Services).

● Limit on Number of Credits per Semester / Year

There is an upper limit on the number of credits a student may register for in a semester and in a year (maximum credit limit), so that the students will be able to have sufficient study hours to earn the credits and maintain the academic level of their studies.

Maximum credit limits differ depending on the Department and the matriculated year; please check the “Notes on Taking Courses” of your Department.

- ※ The maximum credit limit is the upper limit of credits a student may register. It includes courses attempted for which he/she did not earn credits (courses the student withdrew from (W) and courses that were given a grade of F).
- ※ When the sum Spring Semester upper limit and Autumn Semester upper limit is geater than Annual maximum credit limit, you can register up to Annual limit only.

■ Example of maximum credit limit

Autumn	Spring	Annual
26	26	44

If a student registered 26 credits in the Autumn Semester

→ In Spring Semester, the student is allowed to register only up to the annual limit.

Annual maximum credit limit (44 credits) – Spring Semester (26 credits) = 18 credits

The above calculation is only an example. Please thoroughly read the pages of your Department to create your annual course enrollment plan.

● Repetition of a Course

If a student repeats the same course it will not be approved as credit required for graduation.

Repetition of the same course generally means courses with the same course code number.

In general, it is not allowed to take a course for which a student has already earned credits, but there are some exceptions.

For more information, refer to the sections for each Faculty/Department and for General Studies (*Zengaku-Kyotsu Kamoku*) courses.

● Lottery Courses

Lottery courses are courses with limited class capacities.

The class capacity is shown in the Notes column as “number of students” on the List of Courses and Instructors.

If you wish to take a lottery course, students must register on Loyola during the Lottery Registration of each semester.

The lottery is conducted by computer and the successful students will automatically be registered for the course.

If you are selected for a lottery course, you may delete the registration for the successful course during the course registration period or the course adjustment period (with exception).

(Undelatable Courses: ex. Studies in Christian Humanism etc.) For details, see Loyola Bulletin Board/Academic Services.

■ Registration procedures for lottery courses

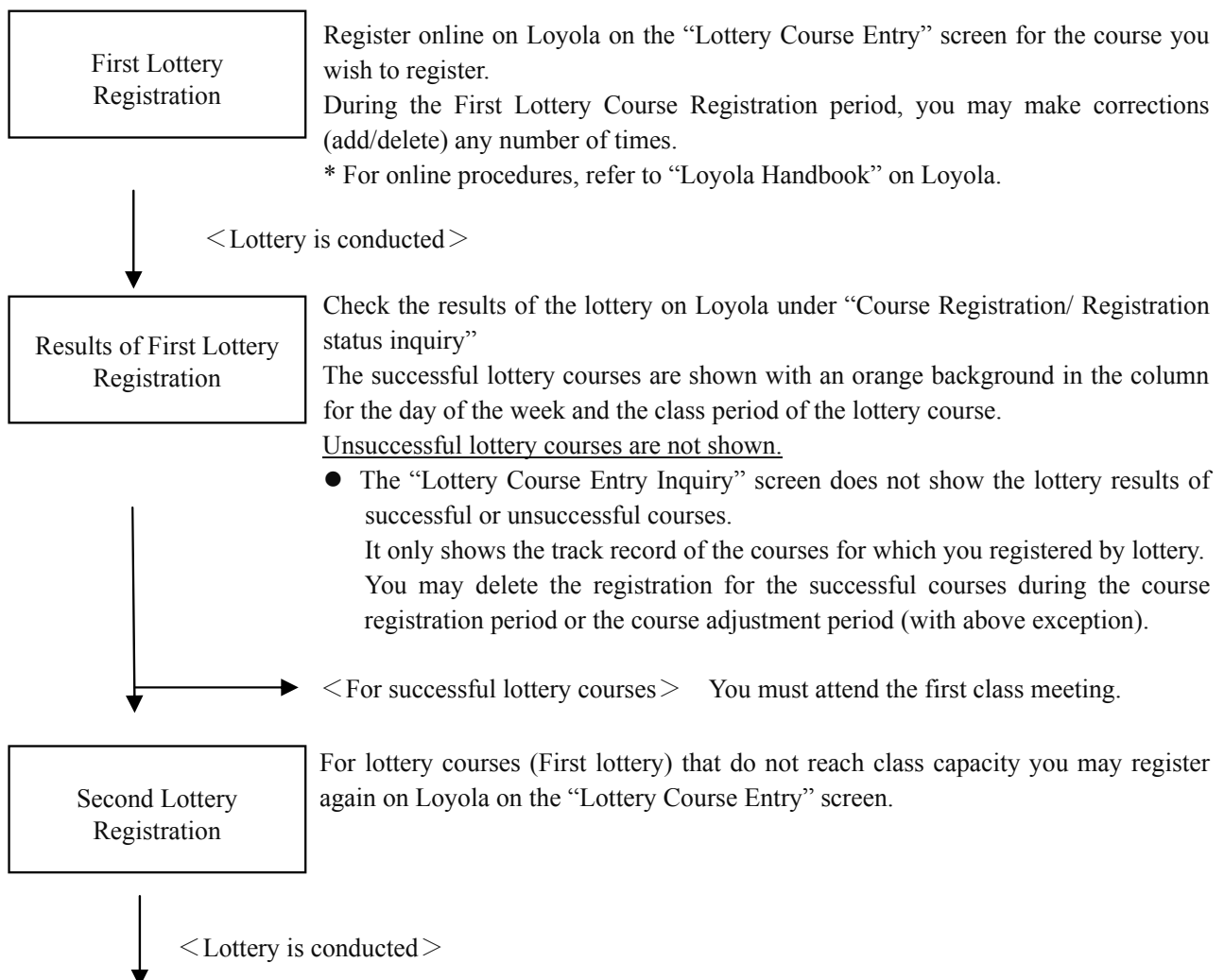

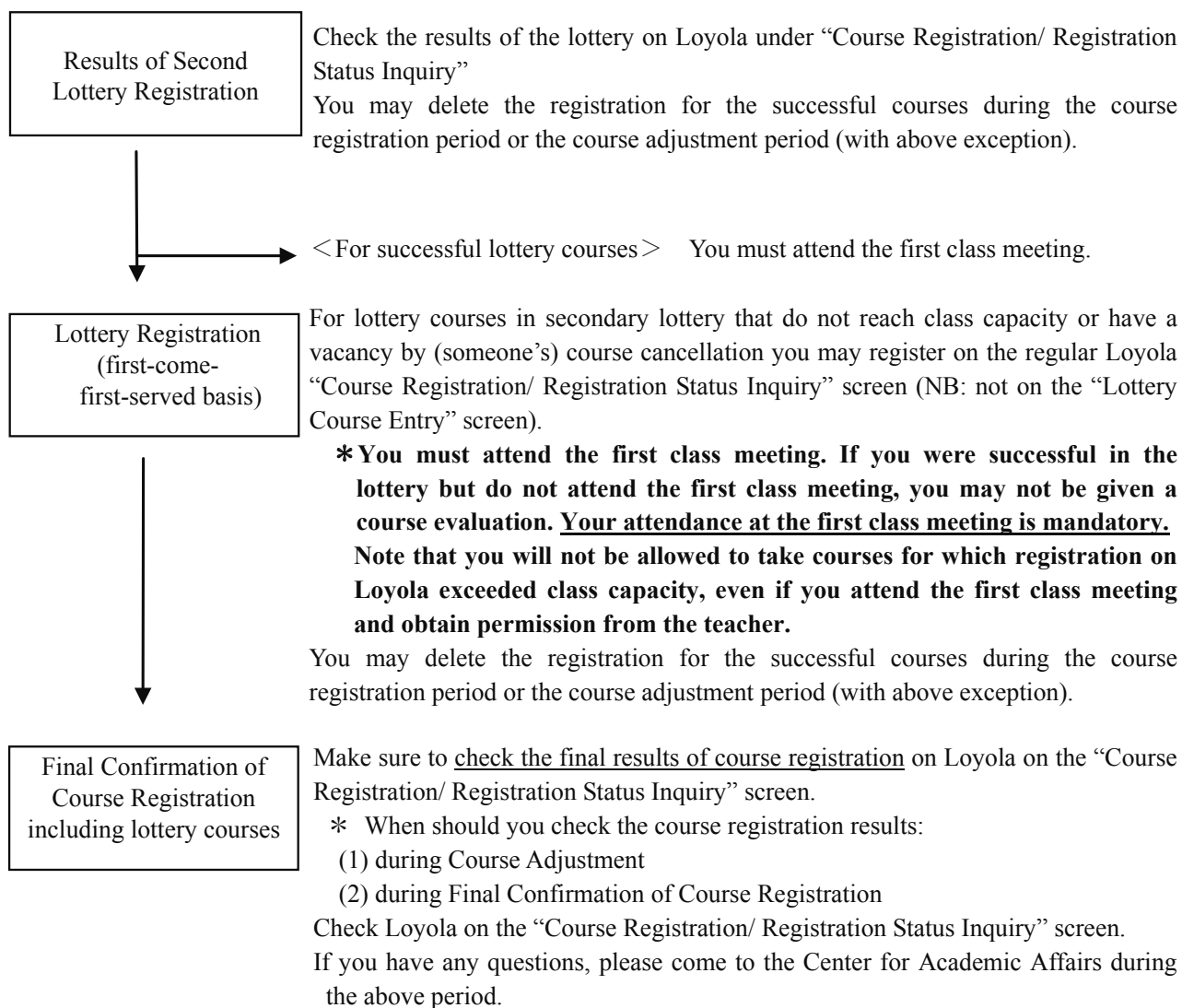

- * If errors occur in the lottery (ex. limit of maximum credits per year, etc.), the details of the errors are shown on the Lottery Course Entry screen.

● Points to Note on Course Registration

- Point to note on Course Registration procedures
 - For Course Registration procedures, read carefully “Loyola Handbook” (access also available from Loyola menu). New students should also read “Course Registration Quick Navi”.
 - Course Registration on Loyola should be completed by the final deadline time on the last day of course registration. (Registration is completed when you click the “Complete Registration” button on the “Course Registration/ Registration Status Inquiry” screen). Note carefully that, your registration is not completed unless you click the “Complete Registration” button by the final deadline time. No special arrangements will be made for anyone who fails to register for courses due to problems with computers or communications environment on the final registration deadline day. Make sure to allow enough time to complete your registration.
 - On the final day of registration, internet congestion is anticipated. Try to complete your registration earlier, if possible one day prior to the deadline. During the Course Registration period, you are allowed to make corrections (add/delete) any number of times even after you have clicked the “Complete Registration” button.
 - After completing your course registration, make sure to check for any errors in registered courses during the registration period. When you click the “Complete Registration” button and you do not make any further changes before the final deadline time, this will be registered as final.
 - We recommend that you print out the final screen of the “Course Registration/ Registration Status Inquiry” or copy and save the screen data. To print it out, click the “Complete Registration” button, log out once and then login again; print out this screen.

5. Enrollment in Courses Offered by Faculty of Liberal Arts

● Application Procedure for Course Enrollment

Students of the Faculty of Science and Technology, Program in English, may register on Loyola for some courses offered by the Faculty of Liberal Arts. (100 and 200 level courses)

For the courses you cannot register on Loyola, take the following procedures:

Required documents : Registration Request Form

<Registration procedures>

- ① During the Course Registration period, download Registration Request Form and Course Schedule from the Loyola Bulletin Board (Academic Services) and make your course enrollment plan. To select the courses you wish to enroll in, check the syllabus on Loyola.
- * Note: the following courses are compulsory courses for degree students of the Faculty of Liberal Arts and are not available for enrollment by students of other Faculties.

ENG001 BASIC SKILLS (WRITING)
 ENG110 ACADEMIC ENGLISH SKILLS
 ENG111 ENGLISH COMPOSITION 1
 ENG112 ENGLISH COMPOSITION 2
 ENG115 PUBLIC SPEAKING
 THP101 THINKING PROCESSES

- ② Fill out the Registration Request Form and submit it during the Course Registration or Course Adjustment period to the Center for Academic Affairs (Academic Services).
 You cannot register for these courses on Loyola. (For information on the registration schedule, check the Loyola Bulletin Board of the Center for Academic Affairs (Academic Services).) Pay particular attention to the following:
 - * Once you submit the Registration Request Form, you cannot withdraw the request. To cancel a course for which you submitted a Registration Request Form, you need to withdraw during the withdrawal period.
- ③ Priority for the lottery courses offered by Faculty of Liberal Arts (300 and 400 levels) is given to degree students of the Faculty of Liberal Arts. These courses will be available to students of other Faculties only when the courses do not reach enrollment limit.

Courses registered on Loyola are given priority in course registration. Therefore, your registration requests for courses will be invalid if there is a course conflict between courses registered via Loyola and your registration request form. Your registration will also become invalid if you register for courses of the Faculty of Liberal Arts and your registration exceeds the maximum credit limit per year. Check the result of your registration on "Course Registration" screen of Loyola during the registration period.

● Summer Session in Asian Studies

Students may take Summer Session in Asian Studies courses offered by the Faculty of Liberal Arts. The course registration period is June 12 (Mon) to June 16 (Fri), 2017. Summer Session courses are not counted into maximum credit limits per semester or year. More information on registration procedures and programs will be posted on the Loyola Bulletin Board (Academic Services) in early June.

Summer Session courses charge separate tuition and fees.

6. Course Withdrawal

● Withdrawal from Courses

If a student decides after the registration period not to finish a course for which he/she has registered, the student should apply to withdraw from the course online (Loyola). A “W” means that the student has asked for and obtained permission to withdraw from the course. This mark will remain permanently on the student’s record, but will not appear on the official transcript. If a student discontinues attending a course and does not complete withdrawal online during the withdrawal period, he/she will receive an “F” for the course. The grade of “W” will not be calculated into the student’s GPA, but an “F” will.

• Withdrawal Period

Semester	Period	Results of Withdrawal available	Notes
Spring	May 8 (Mon) 10:00~ May 11(Thu) 18:00	May 15 (Mon) 10:00~	• For courses offered in the first half of spring semester
	June 5 (Mon) 10:00~ June 9(Fri) 18:00	June 13 (Tue) 10:00~	• For courses offered in the spring semester • For courses offered in the latter half of spring semester
Autumn	Oct 23 (Mon) 10:00~ Oct 26 (Thu) 18:00	Oct 30 (Mon) 10:00~	• For courses offered in the first half of autumn semester
	Dec 4 (Mon) 10:00~ Dec 8 (Fri) 18:00	Dec 12 (Tue) 10:00~	• For courses offered in the autumn semester • For courses offered in the latter half of autumn semester

● Points to Note on Course Withdrawal

■ Courses from which you are not allowed to withdraw:

- ① Compulsory courses (both General Education and Specialized Education courses)
- ② Language courses (for exceptions, refer to 【Request by “Course Withdrawal Request”】)
- ③ Teaching practice / curator practice courses
- ④ Courses with class sessions that end before the Course Withdrawal period.

Note that some Departments have courses other than compulsory courses from which you are not allowed to withdraw or some have compulsory courses from which you are allowed to withdraw.

Check the rules for each Department in “Points to note on course enrollment”.

■ Seniors should check carefully whether they have registered for a total of credits and courses to satisfy all graduation requirements.

■ Course withdrawals or cancellation of withdrawals are not allowed outside of the Course Withdrawal period.

During the Course Withdrawal period, you may cancel course withdrawals on Loyola; after the designated period, no cancellations or additional course withdrawals are possible. If you wish to withdraw from a course, allow enough time to submit a request for withdrawal during the designated period. You may register again in the following or later academic years for the course from which you withdrew.

■ You may withdraw from lottery courses

If you are successful in a lottery course but wish to withdraw from the course, you may do so on Loyola. (You are not allowed to withdraw from compulsory courses and some other courses.)

■ Credits included in maximum credit limit

The credits of courses you withdraw from are counted into the maximum credit limit for a semester or a year. If you register for courses offered in the Autumn Semester, be sure to include the credits in your enrollment plan within the maximum credit limit.

■ Check courses withdrawn

No cancellations or additional course withdrawals will be accepted after the Course Withdrawal period. To avoid any errors in the withdrawal procedures, make sure to login to Loyola again to check after you complete your course withdrawal procedures. We recommend that you keep a copy of the screen.

● Request by “Course Withdrawal Request” Forms

The 2017 “Course Withdrawal Request” forms will be given out and submission accepted during the following periods:

Forms given out	Submission Period	Results available	Courses applicable
Spring Semester “Course Withdrawal Request” forms	June 5 (Mon) 9 : 30 ~ June 9 (Fri) 17 : 00	June 13 (Tue) 10 : 00 ~	Spring Semester courses (excluding compulsory courses)
Autumn Semester “Course Withdrawal Request” forms	Dec. 4 (Mon) 9 : 30 ~ Dec. 8 (Fri) 17 : 00	Dec. 12 (Tue) 10 : 00 ~	Autumn Semester courses (excluding compulsory courses)

If the results of your “Course Withdrawal Request” are not shown on Loyola during the given period, immediately inquire at the Center for Academic Affairs (Academic Services).

※ The office is open weekdays only; closed from 11:30 to 12:30.

■ Courses that require submission of Course Withdrawal Request

Specialized Education

GRADUATION RESEARCH 1 • 2 / SEMINAR 1 • 2

* The approval of the Department Chair is required for the above courses. Without the approval signature/seal of the Department Chair on the request form, it will not be accepted even if it is submitted during the submission period.

Foreign Language courses

Course withdrawals for foreign language courses will only be accepted in the following cases. However, we need to check in advance whether or not withdrawal is allowed for the particular course. Bring a printout of the Loyola Course Grades Inquiry screen during the submission period and inquire at the section for Foreign Language courses at the Center for Academic Affairs.

- ① Specialized elective courses
 - ② Courses that do not affect graduation requirements
 - ③ To change the language you wish to take (once you withdraw from a language course, you will not be allowed to enroll in courses for that language in subsequent semesters)
 - ④ When the total number of credits you obtain exceeds the requirements as a result of Credit Transfer Approval for Overseas Short-term Language courses
- * If you take the Credit Transfer procedures it does not automatically mean that you withdraw from the courses. You need to follow the course withdrawal procedures separately.

* You do not need the approval of course instructor or Department Chair.

7. Examinations

● Types of Examinations

Examinations are held during or at the end of term in Spring and Autumn Semesters in the following types:

Type of exam	Exam period / deadline of submission	Announcements of schedule etc.	Make-up exam	Notes
In-class Examinations	Any time during class sessions (usually on the last day of class)	Given in class by the class teacher	Not applicable	Foreign Language courses usually have in-class exams
Final Examinations (written tests)	During Final Exam period	Announced on Loyola by the Center for Academic Affairs (see below for schedule)		Applicable
Final papers	To be submitted by the deadline set at the end of the term		—	General information is announced on the Loyola Bulletin Board; note that the class teacher may give additional instructions in class.

● Announcement of Schedule of Final Exams (Written Exams)/Report Exams

Information on “Final Exams (written exams)” and “Report Exams” will be announced on Loyola by the Center for Academic Affairs as follows;

Information on In-class Exams will be announced as “Other Exams”

	Schedule announced on:	Final Exams (written exams) period
Spring Semester	Monday, July 10, 2017	Monday, July 24, 2017– Saturday, July 29, 2017
Autumn Semester	Tuesday, Jan 9, 2018	Tuesday, Jan 23, 2018 –Tuesday, Jan. 30, 2018

● Examinations (Written Exams) Policy

■ Note the following for taking the exams:

- Check the exam room on Loyola. It is the student’s responsibility to check and to be at the prescribed exam room (note that the exam room may be different from the room where classes are normally held).
Mobile phones and wearable devices must be turned off and put inside a bag. It is not allowed to use such devices as clocks to check the time.
- If you are more than 20 minutes late for the exam, you are not allowed to take the exam regardless of the reasons. The scheduled exam hours will not be extended for any reason including delay of public transport service. Allow enough time to arrive on time to the exam.
- Students are not allowed to leave the class room for the first 30 minutes and the last 10 minutes of the exam.
- No student may leave the classroom unless he/she has submitted his/her answer sheet.
- If a student does not follow the instructions of the proctor or does not observe warnings to stop talking or any other misconduct, his/her exam shall be invalid.

■ Things to bring to the exam

- 1) Student ID Card: it must be placed on the desk. Without the Student ID Card, students will not be allowed to take the exam, regardless of the reasons.
※ If you forget your Student ID Card, you may have a “Temporary Student ID Card” issued at the Automatic Certificate Issuance Machine located on 4th floor of Building No.2 (500 yen fee charged valid for the day of issue only.). However, if you cannot be at the exam room with the “Temporary Student ID Card” within 20 minutes after the start of the exam, you will be considered late for the exam and will not be allowed to take the final exam.
- 2) Pens/pencils
- 3) Underlay Pad : Only if you need to use one; white or any similar color. Using a notebook or a book as an underlay is not permitted.

- Answer sheets
 - Students are given only one answer sheet. Papers other than the given answer sheet are not valid.
 - If a student makes errors on the answer sheet and a new answer sheet is given, he/she must return the first answer sheet.
 - Use a ballpoint or felt pen to fill in your Student ID Number and name. Answer sheets without student ID numbers or names are invalid

● Cheating on Final Exams (written tests) is Strictly Prohibited

Do not be tempted to cheat on written examinations. If a student is found cheating in an exam or violating an exam policy, the University will impose severe punishment. Honest performance is also expected at in-class exams held during class sessions. The following are some actions that would be considered cheating:

[Cheating on written examinations involves]

- bringing in and using non-permitted materials. (cheat sheet etc.)
- exchanging answer sheets with other students; bringing in answer sheets written prior to the exam
- taking the exam for another student or having another student take the exam for you.
- using mobile phones, the wearable devices or other communication devices (you may not use them even as a watch to check the time)
- other actions that violate the rules for administering exams

Students found cheating in written exams during the Final Exam period shall be subject to the following severe punishments

- ① Depending on the degree of misconduct, student shall be given penalties of suspension, dismissal from university or admonitory warning
- ② Student will receive grade F (fail) for the course for which he/she cheated on the exam. Further, as penalty, the grades of all other exams the student took during the final exam period will also become "F"
- ③ Notice will be posted on the campus bulletin board regarding students who were found cheating.

[Penalties for Suspension]

- The suspension period will not be counted in the residence requirement, and the graduation will be delayed.
- Scholarships the student is receiving from the university will be cancelled. Also the student's qualification for study-abroad, overseas short-term language/Study Abroad program, nominations to university-organized programs may be cancelled.

Cheating in written exams involves more than the grade for that one course; it causes a far greater disadvantage for the student involved. Cheating in exams may be an impulse; do not give in to temptation--it has grave consequences. Double check the materials you are allowed to bring into an exam, if any, on Loyola before taking an exam.

● If Public Transport Service is Shut Down

Refer to "If public transport service is shut down" (p.16) in "Common Guidelines".

● Make-up Exams

If students were unable to take the Final Exams held during the final exams week for the following reasons, they may be allowed to take make-up exams by submitting an "Application for Make-up Exams" (form available). To take the make-up exams, the students will need to submit an application for make-up exams during the given period, obtain permission, and pay the make-up exam fees.

No application for make - up examination for Courses that held in - class exams (outside the Final Exams period) is accepted.

1) Legitimate reasons for applying for make-up exams

The legitimate reasons include illness, family emergency of third degree of kinship, disasters, delay in public transport service, and appointment to lay judge system. The application for make-up exams must be accompanied by the following supporting documents to prove that the student was unable to come on the day of the final exam(s). The application procedure must be completed within the specified period.

2) Supporting documents and procedures

When applying for a make-up exam, bring the necessary supporting documents (see below) and a print-out of the Loyola final exam inquiry screen.

1. "Illness"	Medical certificate or permission to return to school issued by a physician (university designated form) ※ Payment receipts are not accepted
--------------	---

The medical certificate must state all of the following:

- a) The name of the illness and a statement by the physician attesting that the student was not in a condition to take an exam on the day of the exam.
- b) Clear statement showing that the student was unable to come to the exam because of scheduled the consultation or because the student was undergoing treatment.
 ※ If the student had to be absent over several days, the medical certificate must clearly show that these days include the consultation day or the treatment period.

If the medical certificate does not state both a) and b), it will be deemed an incomplete and the student will not be able to apply for a make-up exam.

*In the case of an infectious disease, application for the make-up exam(s) must also be filed during the designated application period for the make-up exams. If a student is unable to come to campus due to the infectious disease, please contact the Center for Academic Affairs before the end of the application period.

2. "Bereavement involving third degree of kinship"	Funeral service card/thank you card etc. addressed to funeral guests
--	--

The cards must show the date of the exam the student was unable to take.

※ The travel days will not be applicable to make-up exams.

3. "Delay in public transport service"	Delay certificates issued by the public transport service (indicating the date and the delayed time); a delay certificate printed out from the Internet is also acceptable.
--	---

If the delay in public transport service was 20 minutes or more and a student arrived at the exam more than 20 minutes past the scheduled starting time, he/she may apply for a make-up exam.

However, the application must be filed on the very day of the delay.

※ Note: Applications for make-up exams will not be accepted on the day following the exam day or later.

[NB] If a student is unable to come to the university on the day of the delay for unavoidable reasons, shutdown of public transport service, or a long distance commuting, a "tentative application" must be made by telephone to the Center for Academic Affairs, Make-up Exams section (Tel: 03-3238-3515) before 17:00 on the day of the delay (for exams held on 5th-6th class periods, before the end of the exam time). If the student fails to make the "tentative application" during the above period, or if a proper application is not made following the "tentative application" during specified period, he/she will not be allowed to apply for a make-up exam whatever of the reasons may be.

※ Only delays occurring on a student's normal commuting route between his/her home and the university will be accepted (not accepted if the route is other than from home). The Center for Academic Affairs will check the address given on the "Enrollment Sticker" on the back of the Student ID Card before accepting the application for the make-up exam.

※ The delay certificate must show a delay longer than the actual length of the student's delay. (e.g. if the student arrived 30 minutes past the scheduled exam starting time, the delay certificate must prove a delay of more than 30 minutes); applications for make-up exams will not be accepted if the student came to the university intending in the first place to arrive late for the exam.

※ A proxy applications submitted by someone other than the student himself/herself will not be accepted for reasons of delay in public transport service.

<< If a student comes late to the exam because of a delay in public transport service, the student should take one of the following steps depending on the length of the delay >>

- (1) **If a student arrives within 20 minutes of the scheduled exam starting time:**
If the delay is less than 20 minutes, he/she is allowed to take the exam; go straight to the classroom and take the exam.
- (2) **If a student arrives more than 20 minutes after the starting of the scheduled exam:**
Bring the delay certificate and go immediately to the Center for Academic Affairs (Academic Services) on 1st floor, Bldg. No.2.; have the arrival time checked; submit the delay certificate and a apply for then make - up exam.
★ If it is difficult to decide yourself, go first to the exam room and follow the instructions of the exam supervisor.

If the reason for applying for a make - up exam is “natural disaster”, “selection by lay judge system” or some other reasons, please inquire at the Center for Academic Affairs, Make-up Exam section, for more information on the application procedures.

3) **Make-up exam fee:** 2,000 yen per course

4) **Make-up exam schedule:** Schedule will be announced on the Loyola Bulletin Board for the Center for Academic Affairs (Academic Services).

	2017 Spring Semester	2017 Autumn Semester
Make-up exam application period (submission period of Application for Make-up Exam)	During the Spring Semester Final Exams (late July)	During the Autumn Semester Final Exams (late January)
Payment period of Make-up Exam fee	Late July to early August	Late January to early February
Announcement of Make-up Exams schedule (Loyola)	Late August	Mid- February
Dates of Make-up Exams	Late August to early September ※Students cannot choose make-up exam dates	Mid-February ※Students cannot choose make-up exam dates

The schedule of make-up exam application period and points to be noted will be announced before the Final Examinations on Loyola; Any disadvantages that may arise from failure to check the Loyola Bulletin Boards will be the responsibility of the individual student. Please make sure to check the announcements.

● Cheating on Report Exams is Strictly Prohibited

Never be tempted to cheat or commit any other misconduct in report exams. If a student is found cheating or committing any misconduct, the University will impose severe punishment.

[Cheating on report exams involves:]

- Using sentences (block quotations) quoted from books, materials, or internet websites in your report without citing the sources and pretending that you wrote the sentences. (Plagiarism)
- Using reports that another student (your senior or friend) wrote for the said course or a similar course in the past and presenting it as your own report.

[Misconduct in report exams involves:]

- Writing a report for a course and using the same report to submit for another course.

If the above misconduct is found in the report exam, your class teacher will give the grade F (fail) for the course and you may be summoned and given a severe warning. In addition, the University may apply the same punishment as in cheating on final exams. (cf. p. 33 Cheating on Final Exams)

Cheating or misconduct in report exams sometimes occurs unintentionally and may well be avoided if a student takes a more cautious stance. Read the “Stance on Exams, Reports and Papers” thoroughly to prevent misconduct and comply with the policy of “Academic Honesty”.

● Stance on Exams, Reports and Papers

◆ To promote “Academic Honesty” and to comply with its policy

As the name Sophia indicates, Sophia University respects wisdom in its ultimate form. We ask the students to cultivate an attitude of Academic Honesty based on the following two points; Sophia lays emphasis on its educational principles of respecting others and cooperating with others based on the concept of “Men and Women for Others, with Others”.

(1) Students should respect the research and source of information of their forerunners and contemporaries and conduct independent and in-depth study.

(2) Students should make continued efforts to enhance their basic academic skills.

By observing these points, students will be able to avoid committing acts of academic dishonesty such as breaking research rules (falsifying and fabrication of data) simply because they wish to be academically creative, or giving off research results of others as your own, or also unintentional plagiarism. All these are acts opposed to Academic Honesty.

Final exams are conducted so that a student can check how much he/she has achieved in the studies (written exams or reports). We expect students to be as honest and sincere in the exams as they always are in class. Dishonest acts such as cheating on exams and falsifying reports shall be severely punished. We ask the students to act with respect for wisdom in various scenarios with the Sophian stance of respecting wisdom.

◆ Rules for quotations in reports and papers

To evaluate your class work and give grades, teachers may ask you to hand in reports or papers. When writing the reports or papers, you will need to give your final comments and ideas on analysis. Your ideas and comments should not be limited to self-centered views, so you must learn from the various research conducted in the past and the present and build your research upon these. When writing reports and papers, the following points should be noted.

- 1) If the concepts and ideas, tables and charts that a student uses in the reports and papers are taken from literature, materials or websites, he/she must indicate the exact parts of the literature, materials or websites used.
- 2) If quoting directly from literature, materials, or websites, a student must show that they are quoted by placing the phrases in quotation marks, and cite the exact source.
- 3) Needless to say, a student must write his/her own reports and papers; you must never present reports written by friends, senior students, or family members as your own

If someone you know or a total stranger gives off the essay or paper you wrote as his/her own, what would your reaction be? Citing quotation and references protects the rights of the author, and it is simply a matter of academic manners and ethics for all involved in research and studies. If a student fails to observe the above 1), 2), and does not cite the quotation or show where the ideas were taken from in the literature or materials, the use of the written contents will be considered as data theft or plagiarism. Overseas, this “plagiarism” is strongly rebuked and unintentional copying and pasting of materials from reference literature or websites are considered as plagiarism. If a student gives off papers written by another person as his/her own as stated in 3), this is an act of fraud. If you are found performing such act or data theft, you will be subject to severe punishment and warnings similar to those when found cheating on written examinations. When using quotations or references, observe the following two important rules:

- ▼ (1) If you use quotations or references from books or websites in your report or paper, place footnotes and cite the sources. The styles of quotation citing are different in academic fields; you should ask your instructor for the details. Generally the following information should be given. When quoting from:
 - ◇ books: author, “title of book”, publisher, year of publication, pages quoted
 - ◇ papers in journals: author, ‘title of paper’, “title of journal”, Vol. ○, No.△, year of publication, pages quoted
 - ◇ website: creator, “name of site or article”, <URL http://www. ○○○. △△△>
date you visited the site: year, month, day (or latest updated on-year, month, day)
- ▼ (2) If you need to quote directly from materials written by someone else in your report or paper, put the quoted sentences in quotation marks to make it clear that the quoted sentences are not written by you.
 - ◇ Example for quoting directly in your report/paper:
“(your sentences) the author, Jochi Taro, writes on this subject “(quoted sentences) the meaning of the existence of university should be viewed from three perspectives . . .”
(author: Jochi Taro, year published 20xx, page quoted p.xxx)

The University level quotations must be cited accurately to show exactly who conducted the quoted research and what the results on which you base your research and analysis were. As shown, clear and accurate citing of quotations and references are expected in the practice of Academic Honesty.

8. Evaluation / Grades

● Evaluation Criteria

Academic performance is evaluated by the class teachers according to their teaching and evaluation policies based on results of exams (written, oral, practical), reports and class attendance.

Grading and evaluation criteria are as follows:

		grade	points	QPI	criteria
evaluated	pass	A	100~90	4.0	EXCELLENT
		B	89~80	3.0	GOOD
		C	79~70	2.0	SATISFACTORY
		D	69~60	1.0	PASSING
		P	——	—	PASSING
	fail	F	59 or below	0	FAILURE (did not show results satisfying passing level in a course with passing grades of “A”, “B”, “C”, “D”)
		X	——	—	NOT PASSING (did not show results satisfying passing level in a course with passing grade of “P”)
not evaluated	Withdrawal	W	——	—	Withdrew from course during designated course withdrawal period
	Transfer credits approved	N	——	—	TRANSFERRED FROM OTHER UNIVERSITIES (Approved as credits equivalent to those earned at Sophia)

The following “Grading Guideline” has been implemented by the university from the academic year 2015. The grades should be determined according to this guideline.

【The Grading Guideline】

An “A” should be given to approximately 20% and no more than 30% of the registered students. This policy, however, does not apply to seminars, guidance courses, and lecture courses with registered Students of 30 or less.

Although each course should be graded according to the evaluation criteria indicated in the course syllabus, professors should apply a grading curve to limit the number of A’s to no more than 30% of the students in the course. As a result, when more than 30% of the students receive a raw score of 90 points (out of 100), those students outside the top 30% would receive a lower grade for the course.

● G.P.A. (Grade Point Average)

The Quality Point Index (=QPI: see above list) multiplied by the number of credits for the course determines the quality points (QP) for that course. The sum of all the quality points divided by the total number of credits attempted (excluding courses with grades W, N, P, X) gives the grade point average (GPA). W (withdrawn from course), N (approved course), P (passing), X (failing) are not included in the calculation.

【GPA calculation formula】

$$\frac{4.0 \times \text{credits with A} + 3.0 \times \text{credits with B} + 2.0 \times \text{credits with C} + 1.0 \times \text{credits with D}}{\text{The sum of all the registered courses (excludes courses with W, N, P, X)}}$$

● Grades Release Dates

The grades for Academic Year 2017 will be released as follows:

Courses	Year in school	Release period	Released via
Cumulative grades including Spring Semester	4th year	Aug 28 (Mon) ~	Loyola "Grades Inquiry"
	3rd year	Sep 9 (Sat) ~	
	2nd year	Sep 10 (Sun) ~	
	1st year	Sep 11 (Mon) ~	
Cumulative grades including Autumn Semester	4th year	Feb 23 (Fri) ~	
	3rd year	Mar 16 (Fri) ~	
	2nd year	Mar 17 (Sat) ~	
	1st year	Mar 18 (Sun) ~	

● Request for Grade Review

If a student believes there has been a mistake in the grades, he/she may submit a "Request for Grade Review" to the Center for Academic Affairs. No late requests will be accepted after the deadline.

Courses	Deadline for submission
2017 Spring Semester courses	September. 20 (Wed), 2017 17:00
2017 Autumn Semester courses	March 30 (Fri), 2018 17:00

* For the seniors, there is a separate application period set in each Semester. For the schedule check the Loyola Bulletin Board (Academic Services).

If you intend to submit the request, consider carefully your reasons in light of the course contents and the grading criteria of A to F; read and follow the instructions given out from Center of Academic Affairs.

The following reasons will not be acceptable for submitting a Request for Grade Review:

- ① simply requesting for a re-evaluation and re-grading.
- ② asking the teacher to be lenient (affects your prospective graduation or acquisition of teacher's license etc.)
- ③ complaints based on comparison with other students (your friend had a grade B and you don't understand why you have a C, etc.)
- ④ you do not question the grading itself, but ask for the reason (ask the teacher for feedback, comment, disclosure of exam scores, etc.)
- ⑤ you have only non-specific statements such as "I attended the classes", "I took the exam" etc.

● Guidance for the students whose GPA is less than 0.5

According to Article 40 of University Regulations, students who fail to obtain 32 credits or more in two consecutive academic years shall be dismissed from the university.

To avoid such case, the department individually contacts the students whose GPA is less than 0.5 and give guidance at the end of the academic year.

This system is to give a chance to the students to look back their school life and study plan, and consult faculty staff on their future academic plan. In case the students do not show any improvement on their motivation after the guidance, the university may recommend withdrawal from the university.

For students with any academic problems or physical or mental distress, the university provides consultation throughout the year by not only faculty staff but also counselors and department staff. If you wish to consult, visit the university's official website → "Campus Life" → "Student Support" → "Student Consultation Services".

● Students with no Prospects of Academic Progress

Students who fail to earn a total of 32 credits or more in courses specified by the Departments in two consecutive years (NB) shall be dismissed from the university. For more information, refer to Academic Handbook (履修要覧) (administrative bylaws, Section 1, Article 40, University Regulations),

(NB) Two consecutive years are as follows:

Faculty of Theology, Humanities, Human Sciences, Law, Economics, Foreign Studies, Science and Technology (excluding English Course)	Faculty of Liberal Arts, Faculty of Science and Technology English Course																																
Two consecutive years, in which a student is enrolled; if a student takes a leave of absence, the academic year in which the leave is taken will not be included.	Four consecutive semesters excluding periods of leave of absence																																
(Example) If student takes a leave of absence in the Spring Semester of the previous academic year.	(Example) If student takes leave of absence in Spring Semester of the previous academic year.																																
<table style="width: 100%; border-collapse: collapse;"> <tr> <td style="width: 20%;"></td> <td style="width: 20%; text-align: center;">Spring</td> <td style="width: 20%; text-align: center;">Autumn</td> <td style="width: 20%;"></td> </tr> <tr> <td>● Year prior to preceding year</td> <td style="border: 1px solid black; text-align: center;">enrolled</td> <td style="border: 1px solid black; text-align: center;">enrolled</td> <td></td> </tr> <tr> <td>Preceding year</td> <td style="background-color: #cccccc; border: 1px solid black; text-align: center;">leave of absence</td> <td style="border: 1px solid black; text-align: center;">enrolled</td> <td></td> </tr> <tr> <td>● Current year</td> <td style="border: 1px solid black; text-align: center;">enrolled</td> <td style="border: 1px solid black; text-align: center;">enrolled</td> <td></td> </tr> </table>		Spring	Autumn		● Year prior to preceding year	enrolled	enrolled		Preceding year	leave of absence	enrolled		● Current year	enrolled	enrolled		<table style="width: 100%; border-collapse: collapse;"> <tr> <td style="width: 20%;"></td> <td style="width: 20%; text-align: center;">Spring</td> <td style="width: 20%; text-align: center;">Autumn</td> <td style="width: 20%;"></td> </tr> <tr> <td>Year prior to preceding year</td> <td style="border: 1px solid black; text-align: center;">enrolled</td> <td style="border: 1px solid black; text-align: center;">● enrolled</td> <td></td> </tr> <tr> <td>Preceding year</td> <td style="background-color: #cccccc; border: 1px solid black; text-align: center;">leave of absence</td> <td style="border: 1px solid black; text-align: center;">● enrolled</td> <td></td> </tr> <tr> <td>Current year</td> <td style="border: 1px solid black; text-align: center;">● enrolled</td> <td style="border: 1px solid black; text-align: center;">● enrolled</td> <td></td> </tr> </table>		Spring	Autumn		Year prior to preceding year	enrolled	● enrolled		Preceding year	leave of absence	● enrolled		Current year	● enrolled	● enrolled	
	Spring	Autumn																															
● Year prior to preceding year	enrolled	enrolled																															
Preceding year	leave of absence	enrolled																															
● Current year	enrolled	enrolled																															
	Spring	Autumn																															
Year prior to preceding year	enrolled	● enrolled																															
Preceding year	leave of absence	● enrolled																															
Current year	● enrolled	● enrolled																															
※two consecutive years are the academic years with the ● mark	※two consecutive years are the four semesters with the ● mark																																

When calculating the credits, pay attention to the following:

- Credits are calculated by adding the credits obtained in two consecutive years. For students of the Faculty of Theology, Humanities Human Sciences, Law, Economics, Foreign Studies, Global Studies and Science and Technology (excluding English Course), the credits obtained in the academic year in which the leave of absence took place are not included in the calculation.
- For re-admitted students and second degree students, only the number of enrollment years and credits obtained after they re-entered or were admitted as second degree students will be calculated.
- For transfer students, the number of enrollment years and transfer credits which were approved at transfer admission will be included in the calculation.
- If a study abroad period exceeds one year, the period exceeding a year will be deemed a period of leave of absence.
- Credits obtained during study abroad approved within the consecutive two years will be included in the calculation.

N.B. Preferential Measures

Upon deliberation by the faculty meeting and with an approval of the President, a student who is in the third year or above, and who has taken less than 32 credits in four consecutive semesters excluding the period(s) of leave of absence, may be exempted from dismissal from the University by Article 40, if the total number of credits earned divided by the number of semesters of enrollment is more than 8 credits.

9. Graduation Requirements, Self-Evaluation

● Graduation Requirements

Students enrolled in Sophia University must meet the following two requirements to earn credits and graduate from the university: if you fail to meet either of the requirements, you will not be able to graduate and will need to repeat a year or a semester.

- 1 : To satisfy the residence requirement
(4 years; may vary for transfer, re-entry, and second-degree admission students)
- 2 : To take courses specified and obtain credits for graduation requirements
(Courses and credits required for graduation vary depending on your Department and the year in which you were admitted)

● Check Credits Required for Graduation

(1) Students are responsible for creating their course registration plans and meeting the above graduation requirements. (2) Students also must check that the plan satisfies all graduation requirements. It is the sole responsibility of the students to follow the above processes. The Center for Academic Affairs offers advisory services on course registration, but the office will not be responsible for checking graduation status and credit requirements or calculation for individual students. Students are responsible for checking whether or not they are able to graduate.

● How to Check Credits Required for Graduation

This function is made available to assist the students in checking the number of required credits for graduation by themselves; however, this is a mere calculation of credits on the computer system and is not a service to ensure graduation.

- 1) Check the Bulletin of Information
The courses and credits required for graduation vary depending on your Department and matriculation year.
Please thoroughly read the sections for your Department and matriculation year in the Bulletin of Information on “Courses and minimum number of credits required for graduation”, “Standard course distribution list”, and “Notes on Taking Courses”; check for each course you have taken and the credits earned to which category of credits required for graduation they apply.
 - 2) Check the Loyola “Self evaluation” function
When you have checked the Bulletin of Information as shown in 1) above, please also check the Loyola “Self Evaluation” function as follows:
 - “Self Evaluation” function:
On Loyola you may check your status of courses taken and credits earned for each category of graduation requirements by calculating the missing number of credits you need for graduating from the sum total of credits of courses you are currently taking and the credits you have earned so far.
This function makes it simple and easy for you to check the number of credits required for graduating; however, it is a calculation of credits on the computer system and is not a service to ensure graduation.
 - “Self Evaluation” may not work for certain cases
Some Departments have complicated curriculum and the calculation/display may not work properly. For more details, please check the Loyola Bulletin Board (Academic Services) “Points to be noted on Self-Evaluation screen”.
 - Self Evaluation function available period
The Self Evaluation function on Loyola is available for a designated period only. For the schedule of available periods in the 2017 Academic Year, check the Loyola Bulletin Board (Academic Services).
- * Please note it is not available during course registration periods or withdrawal periods (4th year students may use the self evaluation function during course registration periods).

● Abolition of “Change of Category” on Loyola

Effective from Academic year 2014, the “Change of category” system has been abolished. For courses offered in Academic Year 2014 and later, you will specify the course category at the time of course registration. With the abolition of “Change of category” the following points should be noted:

[For students who entered before 2013]

■ Courses you have already taken in Academic Year 2014 or before;

For these courses you cannot change the category on Loyola. If you wish to make changes in category, you need to submit a designated request form to the Center for Academic Affairs.

■ Courses you taken in Spring Semester of Academic Year 2015 or later:

No changes of category are allowed.

※ Change of category allows you to change the category of courses to meet the graduation requirements; it applies to courses you may select to take as either “General Studies” or “Specialized Education” course. Categories here are the two major groups of courses, “General Studies” and “Specialized Education”. Change of category cannot be used to postpone graduation.

※ The courses to which Change of category may be applied are pre-determined. The following shows the main courses. (Other courses to which change of category may be applied vary by Department; refer to the pages for each Department.)

Courses	Category selected at course registration:	Category may be changed to:
General Studies Distribution (Gakuzen)	Specialized Education courses (Other Faculties/ Departments) [Other – Courses offered also for students of other Faculties/ Departments]	General Studies (General Studies Distribution courses) [General Studies – Electives – General Studies Distribution courses]
Foreign Language	General Studies [General Studies – Foreign Language courses – e.g. English]	Specialized Education courses [Specialized Education – Foreign Language courses – e.g. English]

In recent years, there are cases of students who realize just before their graduation period that they are not eligible to graduate due to serious misunderstandings of credits required for graduation (or the credits they have taken).

To avoid such situations, make sure to carefully plan your course enrollment using the Self-Evaluation function and Bulletin of Information. If you have any questions, inquire as soon as possible at the Center for Academic Affairs.

10. Credit Transfer and Approval

● Credit Transfer and Approval

Credits earned at other universities or colleges before entering Sophia University or credits earned at overseas universities during study abroad after entering Sophia may be transferred and approved as credits equivalent to those earned at Sophia.

The requirements and maximum limit of transfer credits will vary depending on the type of credit transfer. To have credits transferred, check the details before applying for credit transfer.

Requests for credit transfer will be processed among several offices and Departments before the final decision on the approval is made and this may take about a month after application. The decision on approval of credit transfer will affect your future course enrollment plan; apply well ahead to allow sufficient time for the approval procedure.

For procedures to transfer credits obtained during study abroad, read “Procedures for credit transfer and approval of study abroad credits”.

● Grades of Courses with Transferred Credits

The credits transferred and approved will be marked “N (認定 *Ninteī*)” on your transcript of records. Except for compulsory courses, basically the courses with transferred credits will not be listed under the course titles, but will be summed up by course category (elective compulsory, elective, group xx).

The grades marked “N(認定 *Ninteī*)” will not be counted into “Maximum credit limits” per semester or year at course registration; such grades will also not be included in the GPA calculation.

● Application Period for Credit Transfer and Approval

Depending on submission date of credit transfer application, the approved credits may be included in either “Spring Semester” or “Autumn Semester” and will be marked “N 認定 *Ninteī*”

- February 2 (Thu), 2017 – July 21 (Fri), 2017: application submitted to Center for Academic Affairs
→ approved as credits for 2017 Spring Semester
- July 24 (Mon), 2017 – January 30 (Tue), 2018: application submitted to the Center for Academic Affairs
→ approved as credits for 2017 Autumn Semester

● Transfer of Pre-matriculation Credits

Students who entered Sophia University as freshmen (or re-admitted students or second degree students) may apply for credit transfer for up to 30 credits earned at other universities, colleges, higher professional schools or Sophia School of Social Welfare prior to matriculation (must apply within 3 months after entering Sophia). However, credits previously approved as Sophia credits are excluded. For more information, inquire at the Center for Academic Affairs (Academic Services). Also read the “Bylaw on Transfer of Pre-matriculated Credits”.

● Credit Transfer of Transfer Students

Transfer students may apply for transfer of credits earned at other universities to be approved and counted as equivalent to credits required for graduation at Sophia.

■ Maximum limit of credit transfer

- 1) Credit transfer will be approved in categories of General Studies (*Zengaku-Kyotsu-Kamoku*) and Specialized Education respectively up to the number of credits required for graduation set by each Department.
- 2) The maximum number of credits that can be transferred will be decided by each Department up to one half of the credits required for graduation set by the Department.

Also read the “Bylaw on Credit Transfer of Transfer Students”.

● Credit Transfer for Teacher Certification Program

Transfer credits approved as credits earned at Sophia University may be approved as credits for the teacher certification program. If a student wishes to apply for credit transfer for the teacher certification program, inquire at the Center for Teaching and Curator Credentials.

● Graduate School Pre-admission Course Enrollment System

Undergraduate students who show excellence in their academic performance may enroll in courses designated by each Graduate School in their senior year following a screening. On admission to Sophia University Graduate School, the credits earned in such courses will be approved as pre-admission credits up to the maximum number set by the Graduate School.

Credits earned through the system of course enrollment prior to admission to Graduate School will not be approved as credits required for undergraduate graduation.

The Graduate Schools/Programs that have a system of course enrollment prior to admission to Graduate School are as follows:

- Graduate School of Theology
- Graduate School of Humanities, Master's Program in French Literature
- Graduate School of Human Sciences, Master's Program in Social Services
- Graduate School of Law, Juris Doctor Program
- Graduate School of Economics
- Graduate School of Global Environmental Studies
- Graduate School of Science and Technology

For more information, please read "Bylaw on Graduate School Pre-admission Course Enrollment of Undergraduate Degree Students"

● Credit Transfer by Student Exchange Agreement

If a current student earns credits at another university in Japan affiliated by a student exchange agreement, the credits will be transferred and approved as credits equivalent to those earned at Sophia.

There are two types of student exchange agreement: "in-country exchange type" and "credit transfer type".

Credits earned by Sophia students at the Japanese Universities with an exchange agreement will be approved as credits earned at Sophia, up to 30 credits for "In-country exchange type" and 10 credits for "Credit transfer type".

For more information on student exchange agreement, inquire at the Center for Academic Affairs (Academic Services)

Type	Exchange University	Maximum transfer credits	Form of exchange
In-country exchange	Seisen Jogakuin College Elizabeth University of Music Nagasaki Junshin Catholic University Fuji Women's University	30 credits	Exchange students continue to be enrolled at Sophia University (student status at Sophia will be "study abroad"); during exchange period, students will take courses and engage in research at the host university.
Credit transfer	Tokyo Junshin's University Tokyo College of Music The University of Sacred Heart, Tokyo	10 credits	Students will be enrolled at Sophia and take courses at Sophia and at the same time take courses and engage in research at the host university.

● Credit Transfer from Study Abroad

As a current student, if you earn credits on a student exchange program (study abroad at an overseas university under a student exchange agreement with Sophia) or on general study abroad (at a degree-awarding university approved by the Department Chair prior to studying), the credits will be transferred up to 30 credits and approved as credits equivalent to those earned at Sophia (must apply within 3 months after returning to Japan).

■ Calculation of credit transfer

(1) Most universities including US

One class hour (in minutes) \times number of classes in a week \times course duration (number of weeks) \div basic class hours at Sophia

(2) Universities in Spain, Brazil etc.

Total class hours in a year \times 60 (in minutes) \div basic class hours at Sophia

Basic class hours at Sophia

Type of courses	Basic class hours
Lectures/seminars	675 min (1 Credit)
Languages/seminars	1,350 min (1 Credit)
Experiments	2,025 min (1 Credit)
Physical exercise	1,350min (1 Credit)

* Note that for credit transfer, you must have the class schedule which is the basis for the calculation.

※ Approved credits “N” will not be counted into maximum credit limit per year. They will not be included in the GPA Calculation.

For more information, refer to the “Handbook for Study Abroad” issued by the Center for Global Discovery.

11. Overseas Short-term Language Program/ Overseas Short-term Study Abroad Programs/ Social Engagement Program

● Credit from Overseas Short-term Language Programs

The programs are intended for students to participate in language programs at affiliated universities overseas during university vacations and to earn foreign language credits (2 credits). Note: while students in the last semester before expected graduation are eligible to participate in the program, the credits earned cannot be counted towards graduation requirement.

The grades for the language courses will be either “P (pass)” or “X (fail)”.

Courses with grades “P” or “X” will not be included in the maximum credit limit per semester or year at course registration or in calculation of GPA.

For more information on language programs, refer to “Foreign Language Courses” “Academic Handbook” (履修要覧) and “Handbook on Study Abroad” issued by the Center for Global Discovery and also “Bylaw on Overseas Short-term Language Programs”.

● Credit from Overseas Short-term Study Abroad Programs

These programs are intended for students to participate in programs at affiliated universities abroad during university vacations to transfer credits successfully earned, and to have them approved as credits at Sophia. Note: while students in the last semester before expected graduation are eligible to participate in the program, credit transfer will not be possible.

Participating students should have a certain level of language proficiency to study their major subjects taught in a foreign language.

There are two types of Overseas Short-term Study Abroad programs, and credits will be marked differently.

- 1) Credits earned at a university offering the approved program are transferred and approved.
→ Grades will be shown as “N Nintei” (認定)
- 2) Courses registered as courses offered at Sophia;
→ Grades will be shown as “P (pass)” or “X (fail)”.

Courses with grades “P”, “X” or “N” will not be included in the maximum credit limit per semester or year or in the calculation of GPA.

For more information on overseas short-term training program, see “Handbook on Study Abroad” issued by the Center for Global Discovery and also “Bylaw on Overseas Short-term Language Programs”

<List of Overseas Short-Term Study Abroad Programs>

※ The following programs may be changed or cancelled without notice; check the updated information at the Center for Global Discovery.

(1) Credits transferrable to be approved as credits earned at Sophia

University	Language of instruction	Country	Program duration	Credits	Grades and credits
University of California, Los Angeles (UCLA)	English	USA	During summer vacation	Depends on courses taken by the participant	<ul style="list-style-type: none"> * May be approved as General Studies (<i>Zengaku Kyotsu Kamoku</i>) (Electives) or Specialized Education; will not be approved as language courses * Participant should consult the Department Chair before going abroad, and he/she will need to submit request for credit transfer upon return to Japan. * May be approved as credits for 2017 Autumn Semester; the grade given to successful participant will be “N” transfer approved (Nintei).
Ecole Supérieure des Sciences Commerciales d'Angers (ESSCA)	English	Hungary	During spring vacation	Depends on courses taken by the participant	<ul style="list-style-type: none"> * May be approved as General Studies (<i>Zengaku Kyotsu Kamoku</i>) (Electives) or Specialized Education; will not be approved as language courses * Participant should consult the Department Chair before going abroad, and he/she will need to submit request for credit transfer upon return to Japan. * May be approved as credits for 2018 Spring Semester; the grade given to successful participant will be “N” transfer approved (Nintei). * The program is based on an exchange agreement; the tuition is waived. (participants are responsible to pay their air fare, accommodation and meals). If students of the Faculty of Liberal Arts participate and obtain credits that are approved, the tuition equivalent to the transferred credits must be paid.

(2) Courses taken may be considered equivalent to courses offered at Sophia

University	Language of instruction	Country	Program duration	Credits	Grades/credits	Faculty/Dept. offering course
University of California, Davis	English	USA	During summer vacation	2	<ul style="list-style-type: none"> * May be counted as elective Course of Science and Technology Shared Course Group I; will not be approved as credits required for graduation. * Credits will be given in 2017 Spring Semester and successful participants will receive grade “P”. 	Faculty of Science and Technology Common Programs
SOAS University of London	English	United Kingdom	During summer vacation	4	<ul style="list-style-type: none"> * May be counted as General Studies (<i>Zengaku Kyotsu Kamoku</i>) or Specialized Education course; will not be approved as language courses. * Credits will be given in 2017 Spring Semester and successful participants will receive grade “P”. 	Faculty of Foreign Studies
University of Oxford	English	United Kingdom	During summer vacation	2	<ul style="list-style-type: none"> * May be counted as General Studies (<i>Zengaku Kyotsu Kamoku</i>) (Electives) or Specialized Education course; will not be approved as language courses. * credits will be given in 2017 Spring Semester and successful participants will receive grade “P”. 	Faculty of Foreign Studies
University of North Carolina at Charlotte	English	USA	During spring vacation	2	<ul style="list-style-type: none"> * May be counted as elective Course of Science and Technology Common Programs Group I; will not be approved as credits required for graduation.. * Credits will be given in 2017 Autumn Semester and successful participants will receive grade “P”. 	Faculty of Science and Technology Common Programs
Institut d'Etudes Politiques de Paris	English	France	During spring vacation	4	<ul style="list-style-type: none"> * May be counted as General Studies (<i>Zengaku Kyotsu Kamoku</i>) (Electives) or Specialized Education course; will not be approved as language courses. * Credits will be given in 2017 Autumn Semester and successful participants will receive grade “P”. 	Faculty of Foreign Studies

● Credit Transfer of Social Engagement Programs and Intensive Courses

Sophia University has various overseas programs including on-site training courses during the semester and university recess for which you can obtain and transfer credits.

【Social Engagement Programs】

Overseas programs including on-site training courses are available during university recess; the credits obtained for successfully completed courses may be transferred as Elective Courses of General Studies. However, if you intend to graduate at the end of the semester in which you will obtain such credits, you are eligible to participate in the program but no credits will be awarded. The grades given in the programs will be either “P (pass)” or “X (fail)”.

Courses with grades “P” or “X” are not counted into the “maximum credit limit” per semester or year at Course Registration. They are also not included in calculation of GPA.

Note that you need to plan your enrollment carefully as this course involves an overseas tour for which you will be responsible to pay and the course itself may be cancelled if the number of tour participants does not reach the minimum participant requirement.

【United Nations Youth Volunteer Program】

After selection in university and prior training, you will participate in hands-on programs at the United Nations and related organizations during the Autumn Semester. You will not be able to enroll in any other courses in the semester during which you will be dispatched as volunteer. If you complete the training courses prior to and after your volunteer program, you will be evaluated and graded as “P”(pass) or “X”(fail).

For more information (course list etc.), please contact the Center for Global Discovery (B1F Building No.2).

【Internship Courses】

Credits will be given to successful completion of the internship programs conducted under the agreement with Sophia and companies or the Japan office of international organizations. For the internship availability and its program details, (period, company list, etc.) please see p.63 or contact the Center for Global Discovery (B1F Building No.2) for details.

Internship courses are graded as “P” (pass) or “X”(fail), and will not be counted into the “maximum credit limit” per semester or year. They are also not included into the GPA calculation.

Expenses incurred for participating in the program will be a responsibility of each student. In addition, a program may be cancelled, or the program content may be changed for unavoidable reasons.

Academic Records (Notifications/Certificates)

1. Academic Records

... P.50

Student ID No. / Student ID Card / Residence Requirements /
Repeating a Semester / Study Abroad / Leave of Absence / Resuming Studies /
Suspension from University / Withdrawal and Dismissal /
Individual Information / For non-Japanese students (Residence status)

2. Certificates

... P.55

Certificates from the Certificate Issuance Machine
Certificates issued at the Office

3. Change of Faculty•Department/Re-admission/Second degree admission

... P.56

Change of Faculty /Department
Re-admission/Second Degree Admission

4. Early Graduation

... P.57

Early Graduation

1. Academic Records

● Student ID Number

All students are given an individual Student ID Number upon entering the University. The Student ID Number is necessary in all parts of student life; memorize your Student ID Number.

(Example) A 17 11 001

Individual number given to student in the Department
Department number (see List below)
Matriculation year (*)
Student status code ("A" means full-time undergraduate student)

* Transfer, Second degree admission, and Re-entry students are given ID numbers of the relevant matriculation year and this may be different from the actual year of entrance.

■ List of Department Numbers

Faculty	Department	Dept. No.
Theology	Theology	91
Humanities	Philosophy	11
	History	14
	Japanese Literature	15
	English Literature	16
	German Literature	17
	French Literature	18
	Journalism	19
	Human Sciences	Education
Psychology		82
Sociology		83
Social Welfare		84
Nursing		85
Law	Law	31
	International Legal Studies	32
	Legal Studies of the Global Environment	33
Economics	Economics	41
	Management	42

Faculty	Department	Dept. No.
Foreign Studies	English Studies	51
	German Studies	52
	French Studies	53
	Hispanic Studies	54
	Russian Studies	55
	Luso-Brazilian Studies	56
Global Studies	Global Studies	21
Liberal Arts	Liberal Arts (Spring Enrollment)	67
	Liberal Arts (Autumn Enrollment)	68
Science and Technology	Materials & Life Sciences	76
	Engineering & Applied Sciences	77
	Information & Communication Sciences	78

● Student ID Card

The Student ID Card certifies that you are a student of Sophia University. **Carry it with you at all times** as you may be asked to show it in various situations both on and off campus. Note carefully that in the following cases services may not be provided without your Student ID Card.

Student ID Cards **should not be lent or given to another person** regardless of the reason. Return the Student ID card to the university when you lose your student status by withdrawal from university etc.

■ You will need the Student ID Card in the following cases:

- 1) to take exams
- 2) to use the certificate issuance machine and obtain a certificate or student travel fare discount certificate
- 3) to enter the university main library, to borrow library books
- 4) to buy your commuting pass
- 5) to show at the request of officials when you are on trains etc. using a commuting pass or student discount ticket
- 6) to submit various application forms at the office
- 7) to show when requested by a faculty or staff of Sophia University

- **Valid Enrollment Sticker**

The Student ID Card is valid only with a current Enrollment Sticker (Zaiseki - kakunin Seal)在籍確認シール affixed on the back. The Sticker is valid for one year; **change to a valid current sticker at the beginning of each academic year**. Notify the Center for Academic Affairs, Academic Records Section, if there are any changes in your address or commuting route or when there are no vacant columns left in the commuting pass issue record.

- **Changes in the data of Student ID Card**

If there are any changes or errors in the data (name, date of birth etc.) on the Student ID Card, notify the Center for Academic Affairs, Academic Records Section.

- **Lost, damaged or defective Student ID Card**

Request a re-issue at the Center for Academic Affairs, Academic Records Section; purchase a fee payment sticker (1,000yen) and place it on the designated form, “Request for re-issue of Student ID Card” (学生証再発行願).

● Residence Requirements

The permitted period of enrollment at Sophia University is 8 years. Periods of leave of absence will not be counted toward the period of enrollment (Article 38, University Regulations). The required period to complete study courses (residence requirement) at Sophia University is 4 years except in cases of early graduation. Periods of leave of absence, suspension from the university, or study abroad exceeding one year are not counted toward the residence requirement (Article 13, Article 57-2, University Regulations).

● Repeating a Semester

A student who fails to complete the graduation requirements in the four years of study after entering the university will have to repeat a semester.

When a student needs to repeat a semester, a Student ID Card with an extended period of validity will be sent by postal mail to the student at the end of March or the middle of September.

● Study Abroad

Sophia university has two types of study abroad program, Exchange Program and General Study Abroad Program. To join these programs, students should submit “Request for Study Abroad (留学願)”. Also students can study abroad taking leave of absence or joining the short term programs held during summer and spring vacation. Depending on the types and period of study abroad, there are differences in the tuition, application materials, inclusion in the residence requirement, and transfer of credits. Students who wish to study abroad should apply after thoroughly reading the “Handbook for Study Abroad” issued by the Center for Global Discovery and planning their study well.

- **Eligibility**

Students who plan to apply for exchange program or general study abroad program should have finished at least 2 semesters and have obtained more than 32 credits at Sophia by the time they begin their study abroad program.

- **Period of Study Abroad**

Students can join study abroad program for one semester or one year without taking a leave of absence. It is possible to extend the study abroad term to 2 years in maximum, but up to one year is considered to the residence requirement.

- **Deadline for submission of the “Request for Study Abroad (留学願)”**

Students who are to join the exchange program, the Center for Global Discovery will provide the deadline for submission.

Students who are to join the general study abroad program should submit the “Request for Study Abroad (留学願)” 1 month prior to start study abroad AND the day before the semester start day.

- **The University-designated Overseas Travel Insurance and Crisis Management Service**

Students traveling overseas as part of university-related programs, including general study abroad program and study abroad during the leave of absence are required to purchase the

university-designated overseas travel insurance and crisis management service. For details, please inquire at the Center for Global Discovery.

■ **Report of Return to Japan**

When students return from a study abroad, they should submit the “Report of Return to Japan (帰国届)” in 1 month. Students who joined the exchange program should submit the Exchange Report Form to the Center for Global Discovery before submitting the Report of Return to Japan.

■ **Transfer of Credits**

Up to 30 credits earned on university pre-approved study abroad can be transferred to (credits earned during overseas study by taking leave of absence do not apply here). For more information, please see p.43, “10. Credit Transfer and Approval” and “Handbook of Study Abroad” issued by the Center for Global Discovery.

● Leave of Absence

A student who wishes to take a leave of absence due to reasons beyond his/her control must consult the Department Chairperson or class teacher and submit the completed “Request for leave of absence” form (休学願). If the reason is illness, it must be accompanied by a doctor’s certificate. If students take a leave of absence and study abroad, they are required to purchase, the university-designated overseas travel insurance and crisis management service. For details, inquire at the Center for Global Discovery.

The period of leave of absence is not counted toward the residence requirement and graduation will be delayed for the duration of the absence. Also, a student who is taking a leave of absence cannot graduate in that semester, even if all graduation requirements are met.

■ **Period of Leave of Absence**

Leave of Absence may be requested per semester (Spring/Autumn semester). A leave of absence may not extend over two consecutive years or a total of 4 years (Article 32 University Regulations).

■ **Deadline to submit request**

	Period of Leave of absence	Deadline to submit request
Spring Semester 2017	April 1 – Sept. 20	May 31 (Wed)
Autumn Semester 2017	Sept. 21 – March 31	Nov. 30 (Thu)

A student who intends to take a planned leave of absence must submit the “Request for Leave of Absence” at least one month prior to the beginning of the academic year or semester of the planned absence.

Any requests submitted after the deadline will not be accepted for any reason. If the request is sent by postal mail, it must be postmarked on or before the deadline date. The request for leave of absence may be submitted for two consecutive years of absence.

■ **Tuition and fees**

There will be a reduction of the tuition and fees during leave of absence. For more details, inquire at the Center for Academic Affairs (Tuition and Fees).

■ **For Foreign Students with College Student Status of Residence**

Students with a “College Student” Status of residence who take a leave of absence may lose their status of residence in Japan. For details, please consult with the Academic Records Section.

● Resuming Studies

When the period for Leave of Absence is over, student status returns automatically to resume studies, so there is no need to submit an “Intent to resume studies” form (復学届). However, in the following cases, it is necessary to submit the “Intent to resume studies” form before beginning of the intended semester.

- 1) leave of absence due to illness (attach supporting doctor’s certificate 医師の診断書)
- 2) a student wishes to return to studies earlier than scheduled; permission for leave of absence was obtained for 2 or more semesters but the student wishes to shorten the period of absence as the reason for taking the leave no longer exists (the period may not be shortened to less than one semester)

● Suspension from University

A student who commits violations such as misconduct in examination shall be given severe penalties including suspension or dismissal from university according to Article 60 of University Regulations. The period of suspension is not counted in the residence requirement and such student will not be able to graduate from university in four years, the normal residence requirement. Student will be able to return to university studies on the day following when the indefinite suspension is lifted or when the term of the definite suspension expires.

● Withdrawal and Dismissal

There are two types of withdrawal from the university: voluntary withdrawal and dismissal.

■ Date of Withdrawal

The date of withdrawal shall be the end of the semester (September 20 or March 31).

■ Voluntary withdrawal

A student wishing to withdraw from university for certain reasons must consult the Department Chairperson or class teacher, complete the “Request for Withdrawal from the University” (退学願) and submit the request to the Center for Academic Affairs (Academic Records Section) **with their Student ID Card**, before the desired date of withdrawal.

Students who intend to withdraw from the university must have paid all tuition and fees for the period prior to the withdrawal.

■ Dismissal from the university

The following students shall be dismissed from the university:

1) Expiry of Period of Enrollment

Students whose period of enrollment (excluding leave of absence periods) exceeds 8 years.

2) Students to whom Article 40 of University Regulations applies

Students who fail to obtain 32 credits or more including subjects specified by undergraduate departments in two consecutive academic years.

3) Failure to pay tuition and fees

Students who fail to pay the tuition and fees before the set deadline.

4) Other reasons

Students to whom Article 60 and 61 of the University Regulations apply.

● Individual Information

■ Change of address or phone number

When there are changes in students' or the guarantors' address or phone number, students should update the information through “Address registration” menu on Loyola. In case the guarantor's address is outside Japan, they should submit the “Address change sheet (住所変更届)” to the Academic Records Section. This option is only for non-Japanese students. When students change their own address, they need to obtain a new enrollment sticker (在籍確認シール) at the Academic Records Section.

■ Change of student's name

If there is a change in student's name, submit a “Name change sheet (氏名変更届)” available at the Academic Records Section, and attach a certificate of residence (住民票の写し) issued by the local government (stating the full name, gender, date of birth; permanent address, family relation information and Individual Number (My Number) is not required).

■ Guarantor

Sophia university requires all students to have a guarantor. Sophia university sends important notices regarding academic affairs and school newsletters to the guarantor's address, or may contact the guarantor in the case of emergency.

A guarantor should be one of the below (listed in order of priority):

1. A parent who lives in Japan
2. A person who lives in Japan and earns his/her living independently
3. A person who earns his/her living independently and who lives in a foreign country (This option is only for non-Japanese students)

- **Change of the guarantor**

If students intend to change the guarantor, they need to submit the “Guarantor change sheet (保証人変更届)” to the Academic Records Section.

- **Change of nationality**

If there is a change in student’s nationality, submit a certificate of residence (住民票の写し) issued by the local government, which includes the full name, gender, date of birth for all students, nationality, status of stay, period of stay, resident card number for non-Japanese students.

- **For non-Japanese students (Residence status)**

All non-Japanese students are required to notice their residence status and period of stay in Japan to Sophia university. When they renew the resident card, they should submit a photocopy of their resident card as soon as possible. Failure of submission may cause various result like suspension of Loyola ID, termination of scholarship benefits, or other inconveniences.

- **Residence status of “College Student”**

Residence permission is the permission for non-Japanese residing legally in Japan for the mid- to long-term who have resident status under the Immigration Control Act (“mid- to long-term residents”). For students who study at an university in Japan may obtain “College Student” status. Non-Japanese people should carry the resident card at all times.

If students take leave of absence or withdraw from the university, they should change the residence status or go out from Japan.

- **Extension of period of stay under the “College Student” residence status**

When students holding “College Student” status intend to extend the period of stay, they should fill out the application for extension of period of stay “For applicant, part 1-3”. The “For organization, part 1-2” must be filled out by the Academic Records Section. The issuing fee is 200 yen and it will take 3 working days.

They can apply for extension from 3 months prior to expiration date at the Immigration Bureau. Please be aware that staying in Japan beyond the period of stay is illegal and may be punished.

- **Change of residence status to “College Student”**

When students intend to change their residence status to “College Student”, they should fill out the application for change of status “For applicant, part 1-3”. The “For organization, part 1-2” must be filled out by the Academic Records Section. The issuing fee is 200 yen and it will take 3 working days.

Register the changes in your status of residence at the residential municipal office within 14 days.

2. Certificates

Various certificates are issued either from the certificate issuance machine or at relevant offices. **Check the types of certificates** you need and apply as follows:

● Certificates from the Certificate Issuance Machine (NB 1)

Certificates	Fees	Day of issue	Notes
Certificate of Attendance (Japanese / English)	¥200	On the same day	Issuance machines are installed on: <input type="checkbox"/> 4th floor, Bldg. No.2; <input type="checkbox"/> Mejiro Seibo Campus (in office center) Service Hours: Mon. - Fri. 9:00 to 17:00 * any changes due to school events will be announced
Official Transcript (Japanese / English)	¥200		
Certificate of prospective graduation (Japanese / English) <small>(NB 2)</small>	¥200		
Student Discount Certificate (ten per year)	free		
Medical Checkup Certificate (university designated form in Japanese only)	¥300		
Temporary Student ID Card (issued only during Final Exam period)	¥500		

Please follow the voice instructions of the certificate issuance machine on how to operate the machine.

- (NB1) A Student ID Card is required to have the certificates issued. The certificate issuance machine is available for current students only.
- (NB2) The Certificate of Prospective Graduation certifies that the student has met all graduation requirements and is eligible to graduate, but it does not mean that the University guarantees the student's graduation.
- (NB3) For the password, inquire at the Center for Academic Affairs (Academic Records Section).
- (NB4) Up to 10 copies of Student Discount Certificate can be issued from the machine. If you need more copy, please inquire at the Center for Student Affairs.

● Certificates issued at the Office

Certificates	Fees	Day of issue
Certificate of prospective acquisition of teacher's license	¥400	Takes 3 working days from day of application
Graduation / Degree Certificate (Japanese / English)	¥300	Application received → Day of issue • Mon/Tue → Fri • Wed/Thu → following Mon • Fri → following Wed
Certificates necessary for application of "Permission to change the status of residence" and "Permission to extend period of stay"	¥200	
Certificate of payment of tuition and fees	¥300	
Official Personal Report	¥500	
Re-issue of Student ID Card	¥1,000	On the same day

Office in charge: Center for Academic Affairs (Academic Records Section); 1F, Bldg. No.2

Office hours: Mon. - Fri. 9:30 - 11:30, 12:30 - 17:00

* Any changes due to school events will be announced on Loyola.

- 1) Complete application forms available at the office.
- 2) Purchase the fee payment sticker from the vending machine and place it on the application form.
- 3) Submit application form with your Student ID Card to the office. Receipts will be issued to the applicant.
- 4) On the day of issue, show the Receipt at the office and receive the certificates.

3. Change of Faculty/Department, Re-admission, Second Degree Admission

● Change of Faculty/Department

Students who wish to change to another Department and who satisfy the following requirements may do so by submitting a request. After submitting the request, the student will take an exam given by each Department.

■ Eligibility

- 1) Student has completed or is expected to complete at least four semesters of study at the time of the requested change (period of leave of absence is not included)
- 2) Student has a 2.6 GPA or higher for credits obtained in Language Courses (only compulsory courses) and General Studies (Zengaku kyotsu). (Only General Studies for students who entered before 2014).
- 3) Student satisfies all requirements set by the Department he/she wishes to change to.
- 4) There is adequate reason for the change.

Note: *Transfer of Faculty/Department is limited to one time.

*Transfer students and Re-admitted students cannot apply.

*Application to transfer to the Faculty of Global studies is not eligible.

● Re-admission

Re-admission is admission of a student who has withdrawn from Sophia University and wishes to enter the same Department he/she had previously enrolled.

■ Eligibility

Student must fall under one of the following:

- 1) Withdrawal under Article 39, University Regulations (Voluntary withdrawal; withdrew on or before March 31, 2017 for Autumn 2017 entry)
- 2) Withdrawal under Article 64, University Regulations (failure to pay tuition and fees; withdrew on or before March 31, 2016 for Autumn 2017 entry)
- 3) Withdrawal under Article 40, University Regulations (32-credit system; withdrew on or before September 20, 2016 for Autumn 2017 entry)
- 4) Withdrawal under Article 60, University Regulations (violation of Regulations; withdrew on or before September 20, 2016 for Autumn 2017 entry)
- 5) Withdrawal under Article 61, University Regulations (violation of Four articles of inappropriate enrollment; withdrew on or before September 20, 2016 for Autumn 2017 entry)

The following students cannot apply for re-entry:

- 1) Withdrawal under Article 38; period of enrollment exceeded the permitted number of years (8 years).
- 2) Students who withdrew again after re-admitted.

■ Application period

Late—May 2017 for Autumn 2017 entry.

● Second Degree Admission

Second Degree Admission is admission of students who have graduated (or are expected to graduate) from Sophia University and who wish to enter another Department for their second Bachelor's degree. When application is submitted, each Department will hold its own examination. Please note that the Departments students may apply for depend on the Department's space availability and may vary by academic year.

For more information, inquire at the Center for Academic Affairs (Academic Records Section).

- ※ The application for Change of Faculty/Department, Re-entry, Second Degree Admission will be available from early May 2017 for Autumn 2017 entry / November for Spring 2017 entry.
For more details early, inquire at the Center for Academic Affairs (Academic Records Section).

4. Early Graduation

● Early Graduation

The basic residence requirement of Sophia University is 4 years. However, students (1) who are enrolled at Sophia for 3 years or more, (2) have completed the required courses for graduation with good academic performance and (3) who wish to graduate early, may request for approval for early graduation. Faculty meeting of the students affiliated faculty will review and decide upon applications for early graduation, which will be forwarded to the President for approval. For more information, please refer to p.70~.

General Studies

Studies in Christian Humanism

… P. 60

Language (Academic Skills)

… P. 61

Health and Physical Education

… P. 62

General Studies Elective Courses

… P. 62

GENERAL STUDIES

Studies in Christian Humanism

Two courses in the category “Studies in Christian Humanism” (キリスト教人間学) for a total of 4 credits are compulsory for all students who are enrolled in the Faculty of Science and Technology. Normally, students must take one course in their first semester and another in the second semester.

Offered in the spring semester (2017)

Philosophy of the Human Person	2cr
Philosophy of Human Rights and Human Dignity	2cr
Philosophy of Religious Language	2cr
Freedom and Leadership: Ignatian Spirituality for Life	2cr

Offered in the autumn semester (2017)

Philosophy of the Human Person	2cr
Philosophy of Religious Language	2cr
Philosophy of Human Nature	2cr
Freedom and Leadership: Ignatian Spirituality for Life	2cr

Please note that places in these courses will be chosen by lottery, so students should register for these courses during the **lottery registration period**. For details, See page 24～.

Language (Academic Skills)

■ Course details

The objective of Academic Skills courses is to prepare students to study the academic subjects required in their fields of specialization. They comprise study skills, including critical thinking, presentation, and discussion skills, as well as academic writing and organization skills.

■ Registration Rules

【For students who entered from 2014】

- Academic Skills must be taken in the following sequence:

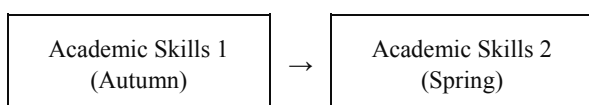

- * Students cannot register for the next course if they have not passed the previous course. (If students have not passed AS1, they cannot register for AS2. They have to re-register for AS1 in the following Autumn semester.)
- * Students cannot register for the same course which they have already passed.
- Students must take all courses and complete 4 credits. (2 credits / course)
- Academic Skills are counted as Compulsory Language.
- No withdrawals are allowed for these courses.
- Students should register for these courses during the registration period.
- Students are strictly required to attend at least 23 classes per semester to pass the courses. (※1)
- Any student who fails to arrive within the first 30 minutes of a class will be regarded as being absent, even if he/she attends the rest of the class.

【For students who entered before 2013】

- Academic Skills must be taken in the following sequence:

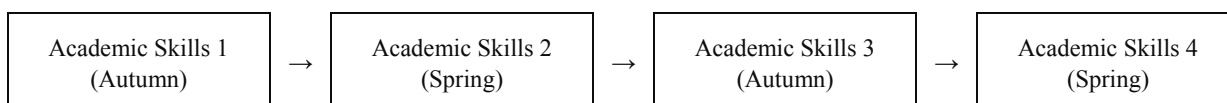

- * Students cannot register for the next course if they have not passed the previous course. (If students have not passed AS1, they cannot register for AS2. They have to re-register for AS1 in the following Autumn semester.)
 - * Students cannot register the same course which they have already passed.
 - Students must take all courses and complete 8 credits. (2 credits / course)
 - Academic Skills are counted as Compulsory Language (General Studies).
 - No withdrawals are allowed for these courses.
 - Students should register for these courses during the registration period.
 - Students are strictly required to attend at least 23 classes per semester to pass the courses. (※1)
 - Any student who fails to arrive within the first 30 minutes of a class will be regarded as being absent, even if he/she attends the rest of the class.
- * Academic Skills 4 will not be offered in 2017. The Students who have not completed this course should register “Academic Communication (Advanced II)” instead. Please consult the Center for Academic Affairs for further information on procedures.

(※1)Special Consideration on Attendance

In any of the following conditions, neither your attendance nor absence will be counted. If applicable, please ask your instructor if you can receive this special treatment.

For up to three weeks, the special treatment will apply. As for the period of absence that went beyond three weeks, regardless of the reasons you may have, the special treatment will not apply. In addition, if the absence is due to more than two circumstance stated below and exceeds three weeks, special consideration will not cover those additional days. Please ask your instructor about the required number of attendance when the special consideration is granted. If your instructor gives you an assignment to make up for your absence, the submission of the assignment becomes the prerequisite for receiving the special consideration.

1. A case of illness or injury where you submit a medical certificate indicating the necessary period of sick or injury leave. (*1)
2. When you join the annual Jo-Nan competition or SOFEX and submit an official certificate of participation.
3. When you have been officially assigned to lay judge (裁判員/Saiban In/) and must assume the duty.
4. When you submit a certificate that confirms your attendance at teaching practice, volunteer experience study (介護等体験 /Kaigotou Taiken/), or museum practice.

(*1) If you have chronic medical conditions and cannot specify periods of sickness or injury leave, you should consult the CLER Office (Floor 5, Bldg. 6) in advance. The deadline for informing the office is; Friday, April 28 (Spring Semester) / Friday, October 20 (Autumn Semester)

Health and Physical Education

“Wellness, the Body and Culture” (ウエルネスと身体), 2 credits, is compulsory for all students. This course should be taken in Autumn semester. The course will be offered in English. Students will be assigned to the appropriate class. An adapted course for students with disabilities will be offered in Spring semester (see Loyola and 履修要覧). Withdrawal is not allowed for compulsory HPE courses.

Details about the course will be announced on the Loyola Bulletin Board (Academic Services).

- **Students entering in 2017** will be assigned to one of the class sections. The class assignment will be posted on Loyola. Students should check the Loyola web service bulletin board and be sure to register for the course they have been assigned to.
- All sections of “Wellness, the Body and Culture” are offered on Wednesday, 13:30-15:00. However, the adapted course for students with disabilities during the spring semester will be offered on Friday, 11:00-12:30.
- Be sure to bring a photo (3 x 3 cm) and a pen to the first class session.
- **Students who entered before 2017 and transfer students** who have not yet completed “Wellness, the Body and Culture”, should come to the meeting room of HPE department (Bldg. No.7, 2F, 220) for registration on April 5(Wed) 10:00~12:00 for Spring semester, or on September 20 (Wed) 10:00~12:00 for Autumn semester. Please note that registration is on a first-come-first-served basis and the number of acceptance is limited. Class will be assigned and a permission sheet will be issued at the registration and it should be submitted to the Center for Academic Affairs during the period below.
< Submission period of permission sheet (During office hours) >
Spring semester : April 12 (Wed) – April 18 (Tue)
Autumn semester : September 27 (Wed) – October 3 (Tue)

General Studies Elective Courses

【For students who entered from 2014】

Students may take courses for 18 credits from programs offered by Faculty of Liberal Arts. They must choose the courses either from 100~200 level courses offered by FLA or the Japanese Language Program. Note that only up to 8 credits are approved for courses from the Japanese Language Program. Students may also take any courses listed in the university-wide General Studies course as Zengaku kyotsu kamoku (全学共通科目). (cf.履修要覧)

* In addition, you must take a two-credit course from the Advanced General Education courses listed in the university-wide General Studies courses in your junior / senior years. (cf. 履修要覧)

Notes on Advanced General Education Courses for FST Students

All students must take at least 2 credits of “Advanced General Education Course” as a part of GS Electives.

- Students may take the Advanced General Education Course from the fifth semester (ie. their first semester in the junior year). The priority will be given to the students in the fifth semester.

- If students take more than 2 credits of Advanced General Education Courses, he/she can count these credits as GS Electives courses.
- In principle, FST students must choose a course(s) from the lottery courses listed below, and register during the lottery registration period.

Advanced General Education Courses for FST students					
Registration CD	Semester offered	Course Title	Credits	Day & Time	Remarks
GSE71900	Spring	Japan in Translation	2	Mon, 2	[100]
GSE71920	Spring	Social Justice in Japan	2	Mon, 4	[100]
GSE71910	Autumn	Business & Management	2	Thu, 2	[100]
GSE72080	Autumn	Catholic Social Thought and the Catholic Church Today	2	Thu, 2	[100] Priority given to FST students

[] = Lottery Courses. Number in brackets is the capacity.

In addition to the above, FST students may also take the course(s) below to fulfill requirement for “Advanced General Education Course.”

Note: Courses include Intensive Courses held during vacation, courses conducted in Japanese, and courses which instructors select students in advance.

Courses available to Students of All Departments					
Registration CD	Semester offered	Course Title	Credits	Day & Time	Remarks
GSE70500	Spring	Bioethical Issues in the Modern Society	2	Intensive course	[90] Conducted in Japanese
GSE70810	Spring	Frontiers of Global Business	2	Intensive course	•Conducted in Japanese •Pre-screening will be conducted※
GSE72040	Spring	Musical Theatre and Middlebrow Culture	2	Intensive course	[90]
GSE72060	Autumn	University Management	2	Fri,1	[90] Conducted in Japanese

[] = Lottery Courses. Number in brackets is the capacity.

※ Regarding Pre-screening of GSE70810, see the bulletin board (Center for Global Discovery) on Loyola web-service.

Internship Courses				
Registration CD	Semester Offered	Course Title	Credits	Day & Time
GSE71700	Spring	Global Internships for Senior/Junior (Short-Term)	2	Intensive course
GSE71703	Spring	Global Internships (Long-Term)	6	Intensive course※
GSE71801	Spring	Volvo Group Internship Program- A Door to a World Leader in Sustainable Transport Solutions (Senior/Junior)	2	Intensive course
GSE71701	Autumn	Global Internships for Senior/Junior (Short-Term)	2	Intensive course
GSE71702	Autumn	Global Internships (Long-Term)	6	Intensive course※
GSE71800	Autumn	Volvo Group Internship Program- A Door to a World Leader in Sustainable Transport Solutions (Senior/Junior)	2	Intensive course

Notes on Internship Courses :

- Pre-screening will be conducted for all Internship courses.

As for the conducted language, please refer to course syllabi on the Loyola Web Service in advance. Some courses are offered in Japanese only.

※ “Long-Term Internships Senior/Junior” courses are held during regular class weeks. Therefore, students who participate in these courses are required to adjust their course schedule not to overlap.

- Contact the Center for Global Discovery (Build.2, B1F) for details regarding internship courses.
- In addition to the above, FST students may also take the course(s) below offered by Center for Global Discovery to fulfill requirement for “Advanced General Education Course”

Courses available to Students of All Departments offered by Global Center for Discovery					
Registration CD	Semester offered	Course Title	Credits	Day & Time	Remarks
GSE71930	Spring	Migration and Co-Existence 1: Trade and Inequality	2	Wed, 5	[100] (LAP Course※)
GSE71940	Autumn	Migration and Co-Existence 2: Migration and Development	2	Wed, 5	[100] (LAP Course※)

[] = Lottery Courses. Number in brackets is the capacity.

※ “Sophia-Nanzan Latin America Program (LAP)” is a program which aims at fostering mutual understanding between Latin American countries and Japan. Focusing on the theme “Human Dignity and Harmonization”, the program offers the courses that help students gain a better understanding of global issues common to Japan and the Latin-American countries, such as diversity, social difference, cultural friction etc. The LAP courses conducted in English are open to all students.

【For students who entered before 2013】

Students may take courses for 16 credits from programs offered by the Faculty of Liberal Arts. They must choose the courses either from 100~200 level courses offered by FLA or Japanese Language Program. Note that only up to 8 credits are approved for courses from the Japanese Language Program. Students may also take any courses listed in the university-wide General Studies program as Zengaku kyotsu kamoku (全学共通科目) (cf. Academic Handbook 履修要覧).

■ List of Courses (General Studies Elective Courses offered by FLA)

AHST2510	Development of Japanese Civilization 1
AHST2520	Development of Japanese Civilization 2
AHST2610	History of Chinese Civilization
ASOC2010	Introduction to Sociology
ASOC2100	Introduction to Social Theory
ASOC2250	Introduction to Japanese Society
AANT2020	Introduction to Cultural and Social Anthropology
AANT2200	Anthropology of Japan
AANT2300	Culture and Identity
AART2010	Introduction to Art History/Visual Culture 1
AART2500	Introduction to Art History/Visual Culture 2
ALIT2010	Literary Genres
ALIT2310	Introduction to Japanese Literature
ARPH2010	Introduction to Philosophy
ARPH2020	Fundamentals of Religion
ALNG2100	Introduction to Linguistics
AIBE2000	Principles of Microeconomics
AIBE2010	Principles of Macroeconomics
APOL2010	Theories and Themes of Contemporary Politics
APOL2050	Introduction to International Relations
APOL2100	Introduction to Comparative Politics
APOL2150	Controversies in Globalization
AMTH1111/2	Mathematics and Statistics for Business and Economics
ACOM221A/B/C	Computer Studies 1*
ACOM222A/B	Computer Studies 2*
ACOM223A	Computer Studies 3*
AENV1310	Environmental Issues 1
AGEO2010	Human Geography
AGEO2020	Geography
AMTH1010	College Mathematics

*N.B. The courses with asterisk carry 2 credits each. Other courses listed are 4 credits each.

■SAIMS Program Courses

☆ The Sophia AIMS Program (SAIMS) is a trans-disciplinary program focusing on "Human Development", and its main theme is "Human Ecology: Diversity and Connectivity of Society and Nature". Students from ASEAN countries and Japan will study together in a program that combines the disciplinary frameworks of natural sciences, social sciences, and humanities. All courses are conducted in English (TOEFL iBT79 or its equivalent level is required; the submission of a language score is required for the "Human Ecology: Rivers").

Course No.	Numbering	Course title	Cr.	Semester offered	Instructor	Remarks
099714	GCE207	INTRODUCTION TO TRANS-DISCIPLINARY HUMAN DEVELOPMENT	2	SPR.	Coordinator SUGIURA, Mikiko	※1
099714	GCE207	INTRODUCTION TO TRANS-DISCIPLINARY HUMAN DEVELOPMENT	2	AUT.	Coordinator SUGIURA, Mikiko	※1
ANT302	ANT302	HUMAN ECOLOGY: RIVERS 1	2	SPR.	WATANABE, Takehiro	※2
POL304	POL304	HUMAN ECOLOGY: RIVERS 2	2	SPR.	ITO Takeshi	※2
099710	GCE208	CONSERVATION	2	SPR.	SUGIURA, Mikiko	
099710	GCE208	CONSERVATION	2	AUT.	SUGIURA, Mikiko	
099712	GCL205	ENVIRONMENTAL SCIENCE	2	SPR.	SUGIURA, Mikiko	※3
099712	GCL205	ENVIRONMENTAL SCIENCE	2	AUT.	SUGIURA, Mikiko	※3
099716	GCE210	SUSTAINABLE DEVELOPMENT	2	SPR.	SUGIURA, Mikiko	※3
099716	GCE210	SUSTAINABLE DEVELOPMENT	2	AUT.	SUGIURA, Mikiko	※3

※1: The SAIMS program participants are required to take this course before or after studying abroad under the SAIMS Program (in spring or autumn semester).

※2: ANT302 and POL304 must be taken together in the same semester and require students to submit an application. For more details, please check the syllabus on Loyola and contact the FLA office (Build. 10, 4F).

※3: Green Science and Green Engineering students (FST English Course Students) can include these courses into their Departmental Specialized Education.

■LAP Program Courses

☆ “Sophia-Nanzan Latin America Program (LAP)” is a program which aims at fostering mutual understanding between Latin American countries and Japan. Focusing on the theme “Human Dignity and Harmonization”, the program offers the courses that help students gain a better understanding of global issues common to Japan and the Latin-American countries, such as diversity, social difference, cultural friction etc. The LAP courses conducted in English are open to all students.

Course No.	Numbering	Course title	Cr.	Semester offered	Instructor	Remarks
099741	GCR311	Migration and Co-existence 1: Trade and Inequality	2	SPR.	URAMOTO / ITO	See below
099742	GCR312	Migration and Co-existence 2: Migration and Development	2	AUT.	URAMOTO / ITO	

※1: Students taking these courses are recommended to have at least a score of TOEFL iBT 79 or its equivalent. FLA and Green Science Engineering Students are exempt from this recommendation.

※2: These courses are offered as the Advanced General Education.

<Japanese Language Program>

The Center for Language Education and Research offers various levels of Japanese language courses. Students who need to use Japanese in daily life or wish to employ Japanese language proficiency in the workplace after graduation are encouraged to take Japanese language courses. For details, please refer to the booklet “JAPANESE LANGUAGE PROGRAM”.

Faculty of Science and Technology Curriculum

For all English Course Students

… P.68

Bachelor's Program in Green Science

… P.73

Bachelor's Program in Green Engineering

… P.79

Course List

… P.85

Objectives of Education and Research

To have students gain academic knowledge of a specialized field as their foundation and acquire “combined intelligence,” which is characterized by a wide range of knowledge that would enable them to view other fields objectively, through art-science integrated education, so that they can contribute to solving various problems in today’s highly diversified society.

Objectives of Human Resource Development

To foster human resources who can contribute to “scientific and technological development” by solving various problems in today’s highly diversified society with a broad vision acquired through knowledge of a specialized field and “combined intelligence”.

Curriculum Policy

The curriculum has been designed with the aim of thoroughly teaching specialized fields that would serve as the foundation for students to acquire ingenuity and creativity, and having students acquire “combined intelligence,” which is characterized by a wide range of knowledge for the integration of arts and sciences that would enable them to view other fields objectively, so that they can develop their ability to solve various problems in today’s highly diversified society.

Diploma Policy

A degree is conferred to students who have acquired the ability to solve, with a broad vision of integrated arts and sciences, various problems with science and technology in today’s highly diversified society, have established original research skills on the basis of high ingenuity and creativity, and can contribute to the further development of science and technology.

* The English translation of objectives and policies of the faculty and the departments are provided for information, and the original Japanese version remains the sole official version. If there is any discrepancy between the two versions, the Japanese original should take precedence.

Faculty of Science and Technology Curriculum

For all English Course Students

1. Organization of the Faculty of Science and Technology

The Faculty of Science and Technology aims to provide students with “cross-disciplinary knowledge” that integrates “science” and “technology”. With its motto being “human and environmental support,” the Faculty seeks to produce graduates who are able to take active steps toward realizing human societies that thrive in harmony with nature. It aims to nurture in students the ability to adapt to today’s knowledge-based societies. To this end, the Faculty is made up of the following three departments:

1. Department of Materials and Life Sciences
2. Department of Engineering and Applied Sciences
3. Department of Information and Communication Sciences

Each department offers a variety of unique educational programs. The Department of Materials and Life Sciences aspires to impart to students “new and innovative ways to view materials that are in harmony with nature”; the Department of Engineering and Applied Sciences endeavors to teach students “ways to create materials and devices that will greatly benefit both global and human environments”; and the Department of Information and Communication Sciences seeks to offer students “an in-depth understanding of humans and society through information”.

To meet the diverse needs of internationalization, the Faculty added two new programs taught entirely in English as part of its regular curriculum in September 2012. The Green Science Program offered by the Department of Materials and Life Sciences and the Green Engineering Program offered by the Department of Engineering and Applied Sciences each have an enrollment capacity of 25 students. Students enrolled in those programs are required to complete all courses, take examinations, submit reports, undergo research guidance, and submit their undergraduate thesis in English.

In this Faculty, classes are divided into General Studies (Zengaku Kyotsu Kamoku) and Specialized Education (Gakka Kamoku). Students must take classes that satisfy all of the requirements for their particular programs. However, since the university is a place where students gain academic knowledge through studying, it is important for students to play an active role in planning the content of their own study programs and take full responsibility for their own learning.

2. General Studies (Zengaku Kyotsu Kamoku)

General Studies (Zengaku Kyotsu Kamoku) differ from Specialized Education (Gakka Kamoku) in that they aim to bestow upon students the ability to gain knowledge from a wide range of perspectives. To this end, students are expected to take courses in humanities, social sciences, and natural sciences. Particularly, in today’s world in which industrial technology has such a widespread and important influence over the lives of human beings, it is important for students studying in the Faculty of Science and Technology to gain a solid understanding and ability to make sound judgments with respect to human society, and the environments surrounding us. Such knowledge will help them utilize their expertise in fulfilling their social responsibilities in the future. Therefore, we hope that students will take an open-minded approach when enrolling in General Studies (Zengaku Kyotsu Kamoku) so that their overall learning experience will be both positive and meaningful.

1) Foreign Languages

For students studying science and technology at the university level, there is an increasing need to acquire the ability to read textbooks and other documents as well as to present the results of their research in foreign languages. Furthermore, once they graduate, foreign languages will play an even more important

part in their lives, no matter what career path they choose to specialize in. This stems from the international nature of science and technology, and the trend will increase in the future. However, foreign languages are not only important for practical reason, but will also help students to develop a rich body of knowledge and ways of thinking, which are essential qualities for scientists and technological experts.

This university serves as a bridge among countries, with teams of excellent instructors to provide students with foreign language guidance. We invite students to take full advantage of the opportunities provided by this superlative learning environment. To avoid having regrets in the future, we encourage students to master foreign languages while they are at university and their memory is still sharp.

“Academic Skills” are compulsory courses. Please see p.61

In addition, for those wishing to take Japanese language courses, up to 8 credits can be included in their graduation requirements for an elective course in General Studies (Zengaku Kyotsu Kamoku).

2) Health and Physical Education

Needless to say, maintaining and improving health is important. This is particularly important for students in the Faculty of Science and Technology. Not only do they have to conduct numerous experiments and attend seminars at the university, but also careers after graduation in industries and laboratories may require a high degree of physical and mental strength. Therefore, students should not only enroll in the “Wellness, the Body and Culture” course from among the health and physical education options, but are also encouraged to participate in extracurricular sports activities (in a manner that does not hamper their academic performance) to improve their overall physical strength and maintain a healthy lifestyle.

3. Specialized Education (Gakka Kamoku)

There are four types of Specialized Education (Gakka Kamoku): 1) Faculty of Science and Technology Common Subject Group I and II (which are required for all students in the Faculty of Science and Technology), 2) Core Courses that form the main course groups of each department and 3) Specialized Courses offered by each department. Among these are compulsory courses, compulsory elective courses, elective courses, and optional courses. The optional courses refer to those subjects in which credits are not counted toward graduation.

For the Faculty of Science and Technology General Subject Group I and II, students are not permitted to enroll in courses other than those included in the English course (i.e., courses in Japanese). However, for the Core Courses and Specialized Courses, students are permitted to enroll in courses other than those included in the English Course.

1) Faculty of Science and Technology General Subject Group I

The Faculty of Science and Technology Common Subject Group I includes introductory courses related to science and technology that aim to broaden students’ knowledge of these fields.

This group includes “English for Science and Engineering”.

2) Faculty of Science and Technology General Subject Group II

This group contains courses that students are required to take in preparation for Core Courses and Specialized Courses.

Students can transfer surplus credits from compulsory elective courses to elective courses in the Faculty of Science and Technology Common Subject Group II.

3) Department Core Courses

Department Core Courses are the groups of courses that form the core curriculum for each department, including experiments, seminars, and graduation research.

Experiment-based and practical courses are merged with courses that are taught in Japanese by experienced teaching staff or international teaching assistants. Seminars and graduation research are supervised by faculty members who accept students.

4) Department Specialized Courses

Regarding elective courses among department courses, the number of credits that students are able to allocate from the elective courses in other departments in Faculty of Science and Technology is up to half

of the credits required for graduation.

4. Graduate School

The graduate school at this university offers master's degree programs and doctoral degree programs. Master's degree programs are two years in duration; upon completion students will earn a master's degree. Given that science and technology includes many different fields, the graduate school provides students with a highly specialized education that is based on the knowledge acquired in their undergraduate studies. With advances in science and technology, there is an increasing demand for people to earn masters or doctoral degrees. In addition, reducing the length of study for postgraduate degrees is under consideration. Therefore, we invite students currently enrolled in undergraduate programs to consider continuing their studies at the postgraduate level.

Students who wish to enter the graduate program at Sophia University are able to take certain lectures in their fourth year under the system for graduate school pre-entrance course registration. The credits for the lectures will be admitted as effective credits within the defined limit upon entering the graduate program. Lectures that have been taken under the system for graduate school pre-entrance course registration will not be admitted as effective credits for the graduation of the undergraduate program. For further details of pre-graduate school credits, please check the university bulletin board.

5. Qualifications

By taking the required courses and graduating from one of the departments in this faculty, students can obtain a number of qualifications which may serve as prerequisites for test(s) and/or obtaining licenses. Please refer to the Academic Handbook (履修要覧) for more details on the main qualifications.

6. Faculty of Science and Technology Early Graduation System

【For students who entered from 2016】

The Faculty has an early graduation system in place for students who wish to enroll in a master's program offered by the university as their first priority and thereafter enroll in a doctoral program of the university. Early graduation refers to graduation for students who have spent three years or more at the university (excluding periods of leave of absence from the university) and fulfilled the prescribed procedures, and will graduate upon completion of their 3rd year (six semesters) or half of their 4th year (seven semesters).

1) Qualifications and Procedures for Requesting Early Graduation

1. Students who have met the following conditions upon completion of their 2nd year are eligible to apply for early graduation registration:
 - (1) Have obtained 24 credits or more that count toward graduation from General Studies (Zengaku Kyotsu Kamoku) and have obtained 4 credits or more that count toward graduation from Language, including all the compulsory courses in their 1st year;
 - (2) Have obtained 60 credits or more that count toward graduation from Specialized Education (Gakka Kamoku), including all compulsory courses in their 2nd year;
 - (3) Have a GPA for all the university-wide courses and Specialized Education (Gakka Kamoku) of 3.65 or higher (numeric value in transcript).
2. The application procedures for early graduation registration are as follows:
 - (1) Receive guidance from the department chair regarding the application for early graduation registration at the end of the 2nd year.
 - (2) In addition to registering in Graduation Research I, submit an Application for Early Graduation Registration, only if approval is obtained from the academic supervisor from whom students wish to receive guidance at the beginning of the 3rd year.
 - (3) Receive official approval for the Application for Early Graduation Registration from the above-mentioned academic supervisor for Graduation Research I.
3. Following application for early graduation registration as well as receiving supervision from their academic supervisor, students must submit periodic reports to their academic supervisor about their academic progress and receive appropriate guidance.

2) Predication for Early Graduation

Students who meet all of the following conditions are eligible to make a request for early graduation:

- (1) The student in question wishes to graduate early and has registered a request for early graduation;
- (2) At the time of early graduation, the student has obtained credits in all of the prescribed subjects required for graduation;
- (3) At the time of early graduation, the student has a GPA in both university-wide subjects and

Specialized Education (Gakka Kamoku) of 3.65 or above in grade transcript.

3) **Withdrawal of Registration of Request for Early Graduation, and Changes to the Graduation Period**

Students who wish to change the period in which they want to graduate following registration of a request for early graduation or who want to withdraw the request itself are required to complete the following procedures:

- (1) For changes to the period of desired graduation, the student must receive official approval from their academic supervisor on Notice of Changes to Period of Request for Early Graduation and submit it to the Chairperson of the department by the submission deadline for procedures.
- (2) For withdrawals of requests for early graduation, the student must receive official approval from their academic supervisor on Notice of Withdrawal of Registration of Request for Early Graduation and submit it to the Chairperson of the department by the submission deadline for procedures.

[Procedure] * Please refer to the Loyola bulletin board for distribution of documents and other details.

Documents to be submitted	Submission period	
Application for early graduation registration	3rd year, from October 1 to October 31 (except university non-business days and holidays)	
Notification of change of early graduation date	Until the 3rd year spring semester registration period	
Withdrawal of application for early graduation registration	In the case of withdrawal of early graduation application after completing six semesters	Until 3rd year spring semester course withdrawal period
	In the case of withdrawal of early graduation application after completing seven semesters	Until 4th year autumn semester course withdrawal period

【For students who entered before 2016】

Early graduation refers to students who have spent three years or more at the university (excluding periods of leave of absence from the university), fulfilled the prescribed procedures, and will graduate upon completion of six semesters.

1) **Qualifications and Procedures for Requesting Early Graduation**

1. Students who have met the following conditions upon completion of their 2nd year are eligible to register for early graduation:
 - (1) 【For students who entered from 2014】
Have obtained 24 credits or more that count toward graduation from General Studies (Zengaku Kyotsu Kamoku), and have obtained 4 credits or more that count toward graduation from Language, including all compulsory subjects in the 1st year;
 - 【For students who entered in 2012 and 2013】
Have obtained 30 credits or more that count toward graduation from General Studies (Zengaku Kyotsu Kamoku), including all compulsory subjects in the 1st year;
 - (2) Have obtained 60 credits or more that count toward graduation from Specialized Education (Gakka Kamoku), including all compulsory subjects in the 2nd year;
 - (3) Have a GPA in both university-wide subjects and Specialized Education (Gakka Kamoku) of 3.65 or above.
2. The procedures for requesting early graduation are as follows:
 - (1) Have a member of the teaching staff act as an academic supervisor in the beginning of the 3rd year and, in addition to registering for Graduation Research I, submit an Application for Registration of Request for Early Graduation.
 - (2) Receive official approval on the Application for Registration of Request for Early Graduation from the above-mentioned academic supervisor for Graduation Research I.
3. Following registration for early graduation as well as receiving supervision from their academic supervisor, students must provide periodic reports to their academic supervisor about their academic progress and receive appropriate guidance.

2) **Predication for Early Graduation**

Students who meet all of the following conditions are eligible to make a request for early graduation:

- (1) The student in question wishes to graduate early and has registered a request for early graduation;
- (2) At the time of early graduation, the student has obtained credits in all of the prescribed subjects required for graduation;

(3) At the time of early graduation, the student has a GPA in both university-wide subjects and Specialized Education (Gakka Kamoku) of 3.65 or above in grade transcript.

3) Withdrawal of Registration of Request for Early Graduation, and Changes to the Graduation Period

Students who wish to change the period in which they want to graduate following registration of a request for early graduation or who want to withdraw the request itself are required to complete the following procedures:

- (1) For changes to the period of desired graduation, the student must receive official approval from their academic supervisor on Notice of Changes to Period of Request for Early Graduation and submit it to the Chairperson of the department by the submission deadline for procedures.
- (2) For withdrawals of requests for early graduation, the student must receive official approval from their academic supervisor on Notice of Withdrawal of Registration of Request for Early Graduation and submit it to the Chairperson of the department by the submission deadline for procedures.

[Procedure] * Please refer to the Loyola bulletin board for distribution of documents and other details.

Documents to be submitted	Submission period	
Application for early graduation registration	3rd year, from October 1 to October 31 (except university non-business days and holidays)	
Notification of change of early graduation date	Until the 3rd year spring semester registration period	
Withdrawal of application for early graduation registration	In the case of withdrawal of early graduation application after completing six semesters	Until 3rd year spring semester course withdrawal period
	In the case of withdrawal of early graduation application after completing seven semesters	Until 4th year autumn semester course withdrawal period

Department of Materials and Life Sciences

Bachelor's Program in Green Science

Objectives of Education and Research

To have students learn academic subjects, such as physics, chemistry, biology, environmental science, and materials science, in an interdisciplinary manner, understand the fundamentals of atoms, molecules, macromolecules, and materials related to life phenomena, and improve their ability to apply and practice what they have learned.

Objectives of Human Resource Development

To develop human resources who have new perspectives of materials and life and can work toward the sustainable integration of the global environment and science and technology, so that they can contribute to creating materials and technologies on the basis of new concepts.

Curriculum Policy

The curriculum has been developed with the aim of having students master basic knowledge by integrating physics, chemistry, biology, and the like; learn science and technology linked to the environment, humankind, materials, etc.; understand the fundamentals of atoms, molecules, macromolecules, and materials related to life phenomena; and improve their ability to apply and practice what they have learned.

Diploma Policy

A degree is conferred to students who have gained an understanding of the fundamentals of materials, have acquired new perspectives of materials and life in harmony with nature through investigations of physical/chemical/life phenomena, creation of new materials, and technological development, and can contribute to humankind and the society.

1. Courses and Minimum Number of Credits Required for Graduation

【For students who entered from 2014】

General Studies (Zengaku Kyotsu Kamoku)

Compulsory: 2 credits (Health and Physical Education: 2 credits)

Compulsory electives: 4 credits (Studies in Christian Humanism)

Electives: 20 credits (including Advanced General Education Courses: 2 credits)

Language

Compulsory: 4 credits (English)

Specialized Education (Gakka Kamoku)

Compulsory: 31 credits

Compulsory electives: 11 credits

Electives: 52 credits

Total: 124 credits are required for graduation.

【For students who entered in 2013】

General Studies (Zengaku Kyotsu Kamoku)

Compulsory: 10 credits (Health and Physical Education: 2 credits, Foreign Languages: 8 credits (English))

Compulsory electives: 4 credits (Studies in Christian Humanism)

Electives: 16 credits

Specialized Education (Gakka Kamoku)

Compulsory: 31 credits

Compulsory electives: 11 credits

Electives: 52 credits

Total: 124 credits are required for graduation.

2. Credits Necessary for Graduation

Please see p.76~78

3. Precautions when Choosing Courses

1) Specialized Education (Gakka Kamoku)

(1) Classification of Specialized Education (Gakka Kamoku)

Faculty of Science and Technology General Subject Group I:

These are fundamental courses taken by all students of the Faculty of Science and Technology. Courses in this group consist of compulsory courses (18 credits) and compulsory elective courses (English for Science and Engineering (2 credits)).

Faculty of Science and Technology General Subject Group II:

This group is a continuation from Group I, which consists of common courses that form the foundation for studying specialized courses. While these courses are taken by all students of the Faculty of Science and Technology, some courses are particularly relevant for each department. Therefore, a number of courses are designated as compulsory elective courses by the department. To graduate, students need 26 credits from this particular group, including 6 credits from the compulsory elective courses.

Department Core Courses:

Courses in this group form the educational core of each department and include experiments, exercises, seminars, and graduation research. Some of the experiment-based and practical courses are compulsory elective courses while others are compulsory courses. A combined total of 16 credits from this group must be completed.

Department Specialized Courses:

These specialized courses offered by each department are electives. Students are required to take 32 credits from these courses in order to graduate.

(2) Credits Required for Graduation

To graduate, students are required to take a total of 94 credits from Specialized Education (Gakka Kamoku): 31 credits from compulsory courses, 11 credits from compulsory elective courses, and 52 credits from elective courses.

(3) English for Science and Engineering

Students are required to take the compulsory elective course “ENGL. FOR SCI/ENGINEERING” from the Faculty of Science and Technology Common Subject Group I.

(4) Faculty of Science and Technology Common Subject Group II

Students must complete 6 credits or more from the compulsory elective courses in this group specified by their department. For students taking more than 6 credits, they can count the extra credits toward the Faculty of Science and Technology Common Subject Group II elective courses. Combined with extra credits from compulsory elective courses, students must take 20 credits from the elective courses in this group.

(5) Experiment-based and Practical Subjects from Department Core Courses

Students must take 13 credits from the compulsory courses in the Department Core Courses group.

In addition, they must take 3 or more credits combined with compulsory elective courses from the Department Core Courses group other than English Courses.

(6) Department Specialized Courses

Students must take 32 credits or more from elective courses.

2) Registration Requirements for Graduation Research

- (1) To register for Graduation Research I, the total number of remaining credits out of the minimum number of credits from courses required for graduation (124 credits) must be 20 or less, including the 2 credits for Graduation Research I and II.
- (2) To register for Graduation Research II, students must have completed Graduation Research I.
- (3) Generally, students take Graduation Research I in the autumn semester of the 4th year. Those who meet the above requirements and wish to take it in the following spring semester should inform their department.

3) Limit on the Number of Credits per Year/Semester

The following limitations apply to the number of credits that can be registered in each academic year and semester.

- (Note 1) Even if students are within the limits for registering credits in the autumn and spring semesters, the total number of credits registered in both semesters cannot exceed the annual limit.
- (Note 2) Those who have registered for the Teacher Certification Program are permitted to register for additional courses even though the limit for the semester has been exceeded after they have registered for the program, which is up to 6 credits in each semester (10 credits each year) from their 2nd year.
- (Note 3) Credits for Japanese Courses offered during Spring/Summer Recess will not be included in the maximum credit limit per year/semester (for FST English course students only).

(Credits)

1 st Year			2 nd Year			3 rd Year			4 th Year			Total
Aut	Spr	Annual Limit	Aut	Spr	Annual Limit	Aut	Spr	Annual Limit	Aut	Spr	Annual Limit	
26	27	49	27	26	49	25	27	49	26	27	49	196

【For students who entered from 2017】 Department of Material and Life Sciences (Green Science)

○ General Studies (Zengaku Kyotsu Kamoku) (26credits)

	1st Year		2nd Year		3rd Year		4th Year		
	Autumn Semester course title	Spring Semester course title	Autumn Semester course title	Spring Semester course title	Autumn Semester course title	Spring Semester course title	Autumn Semester course title	Spring Semester course title	
Compulsory									
Compulsory Elective	2cr Health and Physical Education	2cr Studies in Christian Humanism							
Elective	4cr Japanese (~8cr)	4							
	<ul style="list-style-type: none"> 100~200 level courses offered by FLA (p.62~66) General Studies Elective Courses 								
	Advanced General Education Courses								2

○ Language (4credits)

	1st Year		2nd Year		3rd Year		4th Year	
	Autumn Semester course title	Spring Semester course title	Autumn Semester course title	Spring Semester course title	Autumn Semester course title	Spring Semester course title	Autumn Semester course title	Spring Semester course title
Compulsory	4cr Academic Skills 1	2 Academic Skills 2						

○ Specialized Education (Gakka Kamoku) (94credits)

	1st Year		2nd Year		3rd Year		4th Year	
	Autumn Semester course title	Spring Semester course title	Autumn Semester course title	Spring Semester course title	Autumn Semester course title	Spring Semester course title	Autumn Semester course title	Spring Semester course title
Faculty of Science and Technology General Subject Group I	Compulsory 18cr	2cr OVERVIEW OF SCIENCE & TECHNOLOGY	2cr BASIC PHYSICS	2cr BASIC INFORMATICS				
		2cr INTRO. TO SCIENCE & TECHNOLOGY	2cr BASIC CHEMISTRY	2				
		2cr MATHEMATICS A (LINEAR ALGEBRA)	2cr BASIC BIOLOGY	2				
		2cr MATHEMATICS B (CALCULUS)	2cr EXPERIMENTS & EXERCISE OF BASIC SCIENCE	1				
		1cr MATHEMATICS EXERCISE 1	1					
Faculty of Science and Technology General Subject Group II	Compulsory Elective 2cr	ENGL. FOR SCI/ENGINEERING (ENVIRONMENT)		2				
		MOLECULAR BIOLOGY		2				
		ELECTROMAGNETISM		2				
		ORGANIC CHEMISTRY		2				
Department Core Courses	Compulsory 13cr	20 credits must be taken from the FST General Subject Group II elective courses. (Surplus credits from compulsory elective courses can be counted as elective courses.)						
		2cr MATERIALS AND LIFE SCIENCES (PHYSICS)	2cr MATERIALS AND LIFE SCIENCES (CHEMISTRY)	2cr MATERIALS AND LIFE SCIENCES (BIOLOGY)	2cr MATERIALS AND LIFE SCIENCES (LAB. A)	1cr MATERIALS AND LIFE SCIENCES (LAB. B)	1cr MATERIALS AND LIFE SCIENCES (LAB. C)	1cr SEMINAR 1 (GRADUATION RESEARCH 1)
Department Specialized Courses	Compulsory Elective 3cr	CHEMISTRY LAB. 1		1	1	1	1	
		BIOLOGY LAB. 1		1	1	1	1	
Department Specialized Courses	Elective 32cr	CHEMISTRY LAB. 2		1	1	1	1	
		BIOLOGY LAB. 2		1	1	1	1	
Department Specialized Courses	Elective 32cr	BIOLOGY LAB. 3		1	1	1	1	
		日本語のコア選択必修科目		1	1	1	1	

【For students who entered from 2014 to 2016】 Department of Material and Life Sciences (Green Science)

○General Studies (Zengaku Kyotsu Kamoku) (26credits)

	1st Year		2nd Year		3rd Year		4th Year	
	Autumn Semester course title	Spring Semester course title	Autumn Semester course title	Spring Semester course title	Autumn Semester course title	Spring Semester course title	Autumn Semester course title	Spring Semester course title
Compulsory								
Compulsory Elective	2cr Health and Physical Education 2		4					
Elective	20cr <ul style="list-style-type: none"> • Japanese (~8cr) • 100~200 level courses offered by FLA (p.62~66) • General Studies Elective Courses 							
Advanced General Education Courses								
2								

○Language (4credits)

	1st Year		2nd Year		3rd Year		4th Year	
	Autumn Semester course title	Spring Semester course title	Autumn Semester course title	Spring Semester course title	Autumn Semester course title	Spring Semester course title	Autumn Semester course title	Spring Semester course title
Compulsory	4cr Academic Skills 1		2 Academic Skills 2					

○Specialized Education (Gakka Kamoku) (94credits)

	1st Year		2nd Year		3rd Year		4th Year	
	Autumn Semester course title	Spring Semester course title	Autumn Semester course title	Spring Semester course title	Autumn Semester course title	Spring Semester course title	Autumn Semester course title	Spring Semester course title
Faculty of Science and Technology General Subject Group I	18cr Compulsory	2 OVERVIEW OF SCIENCE & TECHNOLOGY	2 MATHEMATICS A (LINEAR ALGEBRA)	2 BASIC INFORMATICS				
		2 INTRO. TO SCIENCE & TECHNOLOGY	2 MATHEMATICS B (CALCULUS)	2				
Faculty of Science and Technology General Subject Group II	2cr Compulsory Elective			ENGL. FOR SCI/ENGINEERING (ENVIRONMENT)	2			
				MOLECULAR BIOLOGY	2			
Faculty of Science and Technology General Subject Group II	6cr Compulsory Elective			ELECTROMAGNETISM	2			
				INORGANIC CHEMISTRY (ANALYTICAL CHEMISTRY)	2			
Department Core Courses	20cr Elective			ORGANIC CHEMISTRY	2			
		20 credits must be taken from the FST General Subject Group II elective courses. (Surplus credits from compulsory elective courses can be counted as elective courses.)						
Department Core Courses	13cr Compulsory			MATERIALS AND LIFE SCIENCES LAB. B	1			1 SEMINAR 2
				MATERIALS AND LIFE SCIENCES (CHEMISTRY)	2			1 GRADUATION RESEARCH 1
				MATERIALS AND LIFE SCIENCES (BIOLOGY)	2			1 GRADUATION RESEARCH 2
Department Specialized Courses	3cr Compulsory Elective			MATERIALS AND LIFE SCIENCES LAB. A	1			
				CHEMISTRY LAB. 1	1			
				BIOLOGY LAB.1	1			
Department Specialized Courses	32cr Elective			CHEMISTRY LAB. 2	1			
				PHYSICAL CHEMISTRY LAB. 1	1			
				BIOLOGY LAB.2	1			
日本語のコア選択必修科目 BIOLOGY LAB.3								
32 credits must be taken from Department Specialized Courses. (Students can include up to 16 credits from the Department Specialized courses of other departments of FST and Japanese program of your department.)								

【For students who entered in 2013】 Department of Material and Life Sciences (Green Science)

○General Studies (Zengaku Kyotsu Kamoku) (30credits)

	1st Year		2nd Year		3rd Year		4th Year	
	Autumn Semester	Spring Semester	Autumn Semester	Spring Semester	Autumn Semester	Spring Semester	Autumn Semester	Spring Semester
	course title	course title	course title	course title	course title	course title	course title	course title
Compulsory								
Compulsory Elective	2cr Health and Physical Education	2cr Studies in Christian Humanism						
Elective	16cr	4cr						
	• Japanese (~8cr) • 100-200 level courses offered by FLA (p.62~66) • General Studies Elective Courses							
Foreign Language Compulsory	8cr Academic Skills 1	2 Academic Skills 2	2 Academic Skills 3	2 Academic Skills 4	2			

○Specialized Education (Gakka Kamoku) (94credits)

	1st Year		2nd Year		3rd Year		4th Year		
	Autumn Semester	Spring Semester	Autumn Semester	Spring Semester	Autumn Semester	Spring Semester	Autumn Semester	Spring Semester	
	course title	course title	course title	course title	course title	course title	course title	course title	
Faculty of Science and Technology General Subject Group I	Compulsory	18cr	2cr	2cr	2cr				
			OVERVIEW OF SCIENCE & TECHNOLOGY	2cr	MATHEMATICS A (LINEAR ALGEBRA)	2cr	MATHEMATICS B (CALCULUS)	2cr	BASIC INFORMATICS
			INTRO. TO SCIENCE & TECHNOLOGY	2cr	MATHEMATICS EXERCISE I	1cr	MATHEMATICS EXERCISE II	1cr	
				2cr	BASIC PHYSICS	2cr	BASIC CHEMISTRY	2cr	
				2cr	BASIC BIOLOGY	2cr	BASIC BIOLOGY EXPERIMENTS & EXERCISE OF BASIC SCIENCE	1cr	
Faculty of Science and Technology General Subject Group II	Compulsory Elective	2cr							
			ENGL. FOR SCI/ENGINEERING (ENVIRONMENT)	2cr					
		6cr							
			MOLECULAR BIOLOGY	2cr	ELECTROMAGNETISM	2cr	INORGANIC CHEMISTRY (ANALYTICAL CHEMISTRY)	2cr	ORGANIC CHEMISTRY
Department Core Courses	Compulsory	20cr	20 credits must be taken from the FST General Subject Group II elective courses. (Surplus credits from compulsory elective courses can be counted as elective courses.)						
		13cr							
Department Specialized Courses	Compulsory Elective	3cr							
Department Specialized Courses	Elective	32cr	32 credits must be taken from Department Specialized Courses. (Students can include up to 16 credits from the Department Specialized courses of other departments of FST and Japanese program of your department.)						

Department of Engineering and Applied Sciences

Bachelor's Program in Green Engineering

Objectives of Education and Research

To foster students' ability to create entirely new values and functions by acquiring knowledge of materials, devices, energy, machinery, and systems, through an in-depth understanding of physics and mathematics.

Objectives of Human Resource Development

To nurture human resources who can, with a flexible mindset, apply and develop a wide range of knowledge and solid expertise acquired, so that they can contribute to solving various scientific and technological problems.

Curriculum Policy

The curriculum has been structured with the aim of having students acquire knowledge of materials, devices, energy, machinery, and systems in mechanical engineering, electrical and electronic engineering, and physics by gaining a deep understanding of physics and mathematics, and improve their ability to create new functions and innovations for existing technologies.

Diploma Policy

A degree is conferred to students who have solid fundamental knowledge of science and technology, have achieved high academic results that can lead to the development of new functions and the creation of functions through innovations of existing technologies, and can contribute to the acquisition of new physical values and the development of ingenious technologies.

1. Courses and Minimum Number of Credits Required for Graduation

【For students who entered from 2014】

General Studies (Zengaku Kyotsu Kamoku)

Compulsory: 2 credits (Health and Physical Education: 2 credits)

Compulsory electives: 4 credits (Studies in Christian Humanism)

Electives: 20 credits (including Advanced General Education Courses: 2 credits)

Language

Compulsory: 4 credits (English)

Specialized Education (Gakka Kamoku):

Compulsory: 28 credits

Compulsory electives: 23 credits

Electives: 43 credits

Total: 124 credits are required for graduation.

【For students who entered in 2012 and 2013】

General Studies (Zengaku Kyotsu Kamoku)

Compulsory: 10 credits (Health and Physical Education: 2 credits, Foreign Languages: 8 credits (English))

Compulsory electives: 4 credits (Studies in Christian Humanism)

Electives: 16 credits

Specialized Education (Gakka Kamoku):

Compulsory: 28 credits

Compulsory electives: 23 credits

Electives: 43 credits

Total: 124 credits are required for graduation.

2. Credits Necessary for Graduation

Please see p.82~84

3. Precautions when Choosing Courses

1) Specialized Education (Gakka Kamoku)

(1) Classification of Specialized Education (Gakka Kamoku)

Faculty of Science and Technology General Subject Group I:

These are fundamental courses taken by all students of the Faculty of Science and Technology. Courses in this group consist of compulsory courses (18 credits) and compulsory elective courses (English for Science and Engineering (2 credits)).

Faculty of Science and Technology General Subject Group II:

This group is a continuation from Group I, which consists of common courses that form the foundation for studying specialized courses. While these courses are taken by all students of the Faculty of Science and Technology, some courses are particularly relevant for each department. Therefore, a number of courses are designated as compulsory elective courses by the department. To graduate, students need 25 credits from this particular group, including 14 credits from the compulsory elective courses.

Department Core Courses:

Courses in this group form the core elements of study of each department and include experiments, exercises, seminars, and graduation research. Some experiment-based and practical courses are compulsory elective courses while others are compulsory courses. A combined total of 17 credits from this group must be completed.

Department Specialized Courses:

These specialized courses offered by each department are electives. Students are required to take 32 credits from these courses in order to graduate.

(2) Credits Required for Graduation

To graduate, students are required to take a total of 94 credits from Specialized Education (Gakka Kamoku): 28 credits from compulsory courses, 23 credits from compulsory elective courses, and 43 credits from elective courses.

(3) English for Science and Engineering

Students are required to take the compulsory elective course “ENGL. FOR SCI/ENGINEERING” from the Faculty of Science and Technology General Subject Group I.

(4) Faculty of Science and Technology General Subject Group II

Students must complete 14 credits or more from the compulsory elective courses in this group specified by their department. For students taking more than 14 credits, they can count the excess credits toward the Faculty of Science and Technology General Subject Group II elective courses. Combined with extra credits from compulsory elective courses, students must take 11 credits from the elective courses in this group.

(5) Experiment-based and Practical Subjects from Department Core Courses

Students must obtain 10 credits from the compulsory courses in the Department Core Courses group.

In addition, they must take 7 or more credits combined with compulsory elective courses from the Department Core Courses group other than English Courses.

(6) Department Specialized Courses

Students must take 32 credits or more from elective courses.

2) Registration Requirements for Graduation Research

- (1) To register for Graduation Research I, the total number of remaining credits out of the minimum number of credits from subjects required for graduation (124 credits) must be 20 or fewer, including 2 credits from Graduation Research I and II.
- (2) To register for Graduation Research II, students must have completed Graduation Research I.
- (3) Generally, students take Graduation Research I in the autumn semester of the 4th year. Those who meet the above requirements and wish to take it in the following spring semester should inform their department.

3) Limit on the Number of Credits per Year/Semester

The following limitations apply to the number of credits that can be registered in each academic year and semester.

- (Note 1) Even if students are within the limits for registering credits in the autumn and spring semesters, the total number of credits registered in both semesters cannot exceed the annual limit.
- (Note 2) Those who have registered for the Teacher Certification Program are permitted to register for additional courses even though the limit for semester has been exceeded after they have registered for the program, which is up to 6 credits in each semester (10 credits per year) from their 2nd year.
- (Note 3) Credits for Japanese Courses offered during Spring/Summer Recess will not be included in the maximum credit limit per year/semester (for FST English course students only).

(Credits)

1 st Year			2 nd Year			3 rd Year			4 th Year			Total
Aut	Spr	Annual Limit	Aut	Spr	Annual Limit	Aut	Spr	Annual Limit	Aut	Spr	Annual Limit	
26	27	49	27	26	49	25	27	49	26	27	49	196

【For students who entered from 2017】 Department of Engineering and Applied Sciences (Green Engineering)

○General Studies (Zengaku Kyotsu Kamoku) (26credits)

	1st Year		2nd Year		3rd Year		4th Year	
	Autumn Semester course title	Spring Semester course title	Autumn Semester course title	Spring Semester course title	Autumn Semester course title	Spring Semester course title	Autumn Semester course title	Spring Semester course title
Compulsory	2cr Health and Physical Education	2						
Compulsory Elective	4cr Studies in Christian Humanism	4						
Elective	20cr							
	<ul style="list-style-type: none"> Japanese (~8cr) 100~200 level courses offered by FLA (p.62~66) General Studies Elective Courses 							
	Advanced General Education Courses							
	2							

○Language (4credits)

	1st Year		2nd Year		3rd Year		4th Year	
	Autumn Semester course title	Spring Semester course title	Autumn Semester course title	Spring Semester course title	Autumn Semester course title	Spring Semester course title	Autumn Semester course title	Spring Semester course title
Compulsory	4cr Academic Skills 1	2	Academic Skills 2	2				

○Specialized Education (Gakka Kamoku) (94credits)

	1st Year		2nd Year		3rd Year		4th Year	
	Autumn Semester course title	Spring Semester course title	Autumn Semester course title	Spring Semester course title	Autumn Semester course title	Spring Semester course title	Autumn Semester course title	Spring Semester course title
Faculty of Science and Technology General Subject Group I	18cr	2cr	2cr	2cr	2cr	2cr	2cr	2cr
	OVERVIEW OF SCIENCE & TECHNOLOGY	2	BASIC PHYSICS	2	BASIC INFORMATICS	2		
	INTRO. TO SCIENCE & TECHNOLOGY	2	BASIC CHEMISTRY	2				
	MATHEMATICS A (LINEAR ALGEBRA)	2	BASIC BIOLOGY	2				
	MATHEMATICS B (CALCULUS)	2	EXPERIMENTS & EXERCISE OF BASIC SCIENCE	1				
	MATHEMATICS EXERCISE	1						
Compulsory Elective	2cr							
					ENGL. FOR SCI/ENGINEERING (ENVIRONMENT)	2		
Faculty of Science and Technology General Subject Group II	14cr							
					MATHEMATICS B2 (CALCULUS OF SEVERAL VARIABLES)	2		
					MATHEMATICS C1 (STATISTICAL DATA ANALYSIS)	2		
					BASIC DIFFERENTIAL EQUATIONS	2		
					GLOBAL, REGIONAL AND LOCAL ENVIRONMENTAL ISSUES	2		
					MOLECULAR BIOLOGY	2		
					THERMODYNAMICS	2		
					ATOMS & MOLECULAR SCIENCES	2		
					ELECTROMAGNETISM	2		
Elective	11cr							
					11 credits must be taken from the FST General Subject Group II elective courses. (Surplus credits from compulsory elective courses can be counted as elective courses.)			
Department Core Courses	10cr							
					ENGINEERING AND APPLIED SCIENCES 1	2		
					ENGINEERING AND APPLIED SCIENCES 2	2		
					ENGINEERING AND APPLIED SCIENCES 3	2		
					ENGINEERING AND APPLIED SCIENCES LAB. 1	1		
Compulsory Elective	7cr							
					GREEN ENGINEERING LAB. 1	1	GREEN ENGINEERING LAB. 2	1
					TOPICS OF GREEN ENGINEERING 1	2	TOPICS OF GREEN ENGINEERING 2	2
					日本語のコア選択必修科目 1~3			
Department Specialized Courses	32cr							
					32 credits must be taken from Department Specialized Courses. (Students can include up to 16 credits from the Department Specialized courses of other departments of FST and Japanese program of your department.)			

【For students who entered from 2014 to 2016】 Department of Engineering and Applied Sciences (Green Engineering)

○General Studies (Zengaku Kyotsu Kamoku) (26credits)

	1st Year		2nd Year		3rd Year		4th Year	
	Autumn Semester course title	Spring Semester course title	Autumn Semester course title	Spring Semester course title	Autumn Semester course title	Spring Semester course title	Autumn Semester course title	Spring Semester course title
Compulsory	2cr Health and Physical Education 1	2						
Compulsory Elective	4cr Studies in Christian Humanism	4						
Elective	20cr • Japanese (~8cr) • 100~200 level courses offered by FLA (p.62~66) • General Studies Elective Courses						Advanced General Education Courses	
								2

○Language (4credits)

	1st Year		2nd Year		3rd Year		4th Year	
	Autumn Semester course title	Spring Semester course title	Autumn Semester course title	Spring Semester course title	Autumn Semester course title	Spring Semester course title	Autumn Semester course title	Spring Semester course title
Compulsory	4cr Academic Skills 1	2 Academic Skills 2	2					

○Specialized Education (Gakka Kamoku) (94credits)

	1st Year		2nd Year		3rd Year		4th Year	
	Autumn Semester course title	Spring Semester course title	Autumn Semester course title	Spring Semester course title	Autumn Semester course title	Spring Semester course title	Autumn Semester course title	Spring Semester course title
Faculty of Science and Technology General Subject Group I	18cr OVERVIEW OF SCIENCE & TECHNOLOGY INTRO. TO SCIENCE & TECHNOLOGY	2 MATHEMATICS A (LINEAR ALGEBRA) 2 MATHEMATICS B (CALCULUS) 1 MATHEMATICS EXERCISE 1 2 BASIC PHYSICS 2 BASIC CHEMISTRY 2 BASIC BIOLOGY 1 EXPERIMENTS & EXERCISE OF BASIC SCIENCE	2	2 BASIC INFORMATICS	2			
Compulsory Elective	2cr ENGL. FOR SCI/ENGINEERING (ENVIRONMENT)	2						
Faculty of Science and Technology General Subject Group II	14cr MATHEMATICS B2 (CALCULUS OF SEVERAL VARIABLES) 2 BASIC DIFFERENTIAL EQUATIONS 2 GLOBAL, REGIONAL AND LOCAL ENVIRONMENTAL ISSUES	2 FOURIER & LAPLACE TRANSFORMS 2 GEOSCIENCE 2 THERMODYNAMICS 2 ATOMIC & MOLECULAR SCIENCES 2 ELECTROMAGNETISM	2	2	2	2	2	2
Elective	11cr 11 credits must be taken from the FST General Subject Group II elective courses. (Surplus credits from compulsory elective courses can be counted as elective courses.)							
Department Core Courses	10cr ENGINEERING AND APPLIED SCIENCES 1 ENGINEERING AND APPLIED SCIENCES 2 ENGINEERING AND APPLIED SCIENCES 3 ENGINEERING AND APPLIED SCIENCES LAB. 1	2 2 2 1	2 2 2 1	2 2 2 1	2 2 2 1	2 2 2 1	2 2 2 1	2 2 2 1
Compulsory Elective	7cr GREEN ENGINEERING LAB. 1 TOPICS OF GREEN ENGINEERING 1 TOPICS OF GREEN ENGINEERING 2 日本語のコア選択必修科目 1~3	1 2 2 1	1 2 2 1	1 2 2 1	1 2 2 1	1 2 2 1	1 2 2 1	1 2 2 1
Department Specialized Courses	32cr 32 credits must be taken from Department Specialized Courses. (Students can include up to 16 credits from the Department Specialized courses of other departments of FST and Japanese program of your department.)							

【For students who entered in 2012 and 2013】 Department of Engineering and Applied Sciences (Green Engineering)

O General Studies (Zengaku Kyotsu Kamoku) (30credits)

	1st Year		2nd Year		3rd Year		4th Year	
	Autumn Semester course title	Spring Semester course title	Autumn Semester course title	Spring Semester course title	Autumn Semester course title	Spring Semester course title	Autumn Semester course title	Spring Semester course title
Compulsory	2cr Health and Physical Education	2						
Compulsory Elective	4cr Studies in Christian Humanism	4						
Elective	16cr							
	* Japanese (~8cr) * 100~200 level courses offered by FLA (p.62~66) * General Studies Elective Courses							
Foreign Language Compulsory	8cr Academic Skills 1	2	Academic Skills 2	2	Academic Skills 3	2	Academic Skills 4	2

OSpecialized Education (Gakka Kamoku) (94credits)

	1st Year		2nd Year		3rd Year		4th Year	
	Autumn Semester course title	Spring Semester course title	Autumn Semester course title	Spring Semester course title	Autumn Semester course title	Spring Semester course title	Autumn Semester course title	Spring Semester course title
Faculty of Science and Technology General Subject Group I	Compulsory Elective	2cr OVERVIEW OF SCIENCE & TECHNOLOGY	2cr MATHEMATICS A (LINEAR ALGEBRA)	2cr BASIC INFORMATICS				
		2cr INTRO. TO SCIENCE & TECHNOLOGY	2cr MATHEMATICS B (CALCULUS)	2cr				
		1cr BASIC PHYSICS	1cr MATHEMATICS EXERCISE	1cr				
		2cr BASIC CHEMISTRY	2cr BASIC BIOLOGY	2cr				
Faculty of Science and Technology General Subject Group II	Compulsory Elective	2cr EXPERIMENTS & EXERCISE OF BASIC SCIENCE	1cr					
		2cr ENGL. FOR SCI/ENGINEERING (ENVIRONMENT)	2cr					
		2cr MATHEMATICS (CALCULUS OF SEVERAL VARIABLES)	2cr MATHEMATICS OF STATISTICAL DATA ANALYSIS	2cr FOURIER & LAPLACE TRANSFORMS	2cr			
		2cr BASIC DIFFERENTIAL EQUATIONS	2cr MOLECULAR BIOLOGY	2cr GEOSCIENCE	2cr			
Department Core Courses	Compulsory	2cr GLOBAL, REGIONAL, AND LOCAL ENVIRONMENTAL ISSUES	2cr THERMODYNAMICS	2cr ATOMIC & MOLECULAR SCIENCES	2cr ELECTROMAGNETISM			
		1cr ENGINEERING AND APPLIED SCIENCES LAB. 1	1cr ENGINEERING AND APPLIED SCIENCES LAB. 2	1cr				
		2cr ENGINEERING AND APPLIED SCIENCES 1	2cr ENGINEERING AND APPLIED SCIENCES 2	2cr				
		2cr ENGINEERING AND APPLIED SCIENCES 3	2cr ENGINEERING AND APPLIED SCIENCES LAB. 1	1cr				
Department Specialized Courses	Compulsory Elective	7cr	1cr GREEN ENGINEERING LAB. 1	1cr TOPICS OF GREEN ENGINEERING 1	2cr TOPICS OF GREEN ENGINEERING 2	2cr 日本語のコア選択必修科目		
		1cr	1cr GREEN ENGINEERING LAB. 2	1cr GREEN ENGINEERING LAB. 3	1cr			
Department Specialized Courses	Elective	32cr	32 credits must be taken from Department Specialized Courses. (Students can include up to 16 credits from the Department Specialized courses of other departments of FST and Japanese program of your department.)					

Course List

Common Subjects in the Faculty of Science and Technology

	Course No.	Numbering	Course title	Cr.	Semester offered	Instructor	Student Year	Remarks
Faculty of Science and Technology Common Subject Group I	SCT1010E	NSC101	OVERVIEW OF SCIENCE & TECHNOLOGY	2	AUT	BRENNER, Tom	1	
	SCT1140E	NSC112	INTRO. TO SCIENCE & TECHNOLOGY	2	AUT	DZIEMINSKA, Edyta	1	
	SCT1150E	MTH111	MATHEMATICS A (LINEAR ALGEBRA)	2	SPR/AUT	TRIHAN, Fabien	1	
	SCT1160E	MTH131	MATHEMATICS B (CALCULUS)	2	SPR/AUT	TRIHAN, Fabien	1	
	SCT1170E	MTH191	MATHEMATICS EXERCISE 1	1	SPR/AUT	TRIHAN, Fabien	1	
	SCT1180E	PHY101	BASIC PHYSICS	2	SPR	WANAJO, Shinya	1	
	SCT1190E	CHM101	BASIC CHEMISTRY	2	SPR	BRENNER, Tom	1	
	SCT1200E	BIO101	BASIC BIOLOGY	2	SPR	NIKURA, Takako	1	
	SCT2030E	INF101	BASIC INFORMATICS	2	AUT	TAKAOKA, Eiko	2	
	SCT1210E	NSC191	EXPERIMENTS & EXERCISE OF BASIC SCIENCE	1	SPR	DANIELACHE / SUZUKI / TAMURA / KATAYAMA	1	
	SCT5130E	NSC207	ENGL. FOR SCI / ENGINEERING (ENVIRONMENT)	2	SPR	BRENNER, Tom	2	
Faculty of Science and Technology Common Subject Group II	SCT6690E	MTH241	MATHEMATICS C1 (STATISTICAL DATA ANALYSIS)	2	SPR	KATO, Takeshi	2	[30], E
	SCT6650E	BIO111	MOLECULAR BIOLOGY	2	SPR	FUJIWARA / SUZUKI	2	S, E
	SCT6700E	MTH132	MATHEMATICS B2 (CALCULUS OF SEVERAL VARIABLES)	2	AUT	SHINODA, Kenichi*	2	E
	SCT6710E	MTH133	BASIC DIFFERENTIAL EQUATIONS	2	AUT	ARAI, Mamiko*	2	E
	SCT6660E	CHM111	INORGANIC CHEMISTRY (ANALYTICAL CHEMISTRY)	2	SPR	BRENNER, Tom	2	S
	SCT6800E	CHM112	ORGANIC CHEMISTRY	2	SPR	SUZUKI, Yumiko	2	S
	SCT6810E	CHM213	PHYSICAL CHEMISTRY	2	AUT	ODAGIRI, Takeshi	2~4	
	SCT6730E	MTH232	FOURIER & LAPLACE TRANSFORMS	2	AUT	ARAI, Mamiko*	3	E
	SCT6740E	PHY208	THERMODYNAMICS	2	SPR	WANAJO, Shinya	2	E
	SCT6750E	BIO251	CELL BIOLOGY	2	AUT	HAYASHI, Kensuke	2~4	
	SCT6760E	PHY209	INTRODUCTION TO QUANTUM MECHANICS	2	AUT	WANAJO, Shinya	2~4	
	SCT6770E	PHY202	ATOMIC & MOLECULAR SCIENCES	2	SPR	KOIKE, Fumihiko*	2	E
	SCT6780E	CHM223	GEOSCIENCE	2	AUT	DANIELACHE, Sebastian	3	E
	SCT6685E	PHY203	ELECTROMAGNETISM	2	SPR	WANAJO, Shinya	2	S, E
	SCT6790E	NSC201	GLOBAL, REGIONAL AND LOCAL ENVIRONMENTAL ISSUES	2	AUT	HUANG, Guangwei	2	E
	SCT6865E	EEE201	ELECTRIC CIRCUITS	2	SPR	MUSTI, Sastry	2~4	★[30]
	SCT6830E	BIO231	FUNDAMENTAL BIOCHEMISTRY	2	SPR	KONDO, Jiro	2~4	

[]=Lottery Courses. Number in brackets is the capacity.

Instructor's name with * = adjunct instructor

★ = Course taught by invited visiting professor

S = Compulsory Elective for Green Science Course Students

E = Compulsory Elective for Green Engineering Course Students

Course List

Department of Materials and Life Sciences (Green Science)

	Course No.	Numbering	Course title	Cr.	Semester offered	Instructor	Student Year	Remarks
Department Core Courses	SML2040E	PHY102	MATERIALS AND LIFE SCIENCES (PHYSICS)	2	AUT	WANAJO, Shinya	2	
	SML2050E	CHM102	MATERIALS AND LIFE SCIENCES (CHEMISTRY)	2	AUT	DANIELACHE, Sebastian	2	
	SML2060E	BIO102	MATERIALS AND LIFE SCIENCES (BIOLOGY)	2	AUT	ARAKI / KAWAGUCHI	2	
	SML2070E	MLS191	MATERIALS AND LIFE SCIENCES LAB. A	1	AUT	DANIELACHE / ARAKI	2	
	SML2080E	MLS291	MATERIALS AND LIFE SCIENCES LAB. B	1	SPR	BRENNER, Tom	2	
	SML3030E	MLS292	MATERIALS AND LIFE SCIENCES LAB. C	1	AUT	BRENNER, Tom	3	AUT (first half)
	SML5130E	CHM291	CHEMISTRY LAB. 1	1	AUT	BRENNER, Tom	3	AUT (latter half)
	SML5140E	CHM391	CHEMISTRY LAB. 2	1	SPR	SUZUKI / USUKI	3	SPR (first half)
	SML5150E	MLS392	PHYSICAL CHEMISTRY LAB.	1	SPR	TANAKA / TAKAHASHI / OKADA	3	SPR (latter half)
	SML5210E	BIO291	BIOLOGY LAB. 1	1	AUT	ARAKI, Tsuyoshi	3	AUT (latter half)
	SML5220E	BIO391	BIOLOGY LAB. 2	1	SPR	ARAKI, Tsuyoshi	3	SPR (first half)
	SML5230E	BIO392	BIOLOGY LAB. 3	1	SPR	ARAKI, Tsuyoshi	3	SPR (latter half)
	SML4030E	MLS301	SEMINAR 1	1	AUT	Supervisor	4	
	SML4040E	MLS302	SEMINAR 2	1	SPR	Supervisor	4	
	SML4050E	MLS401	GRADUATION RESEARCH 1	1	AUT	Supervisor	4	
	SML4060E	MLS402	GRADUATION RESEARCH 2	1	SPR	Supervisor	4	
Department Specialized Courses	SML6490E	PHY303	ATOMIC AND MOLECULAR SPECTROSCOPY	2	AUT	AZUMA, Yoshiro	1~4	
	SML6500E	CHM306	INSTRUMENTAL ANALYSIS	2	AUT	BRENNER, Tom	1~4	
	SML6510E	CHM307	ORGANIC AND NATURAL PRODUCT CHEMISTRY	2	SPR	USUKI, Toyonobu	1~4	
	SML6520E	CHM308	ENVIRONMENTAL ANALYTICAL CHEMISTRY	2	SPR	DANIELACHE, Sebastian	1~4	
	SML6530E	CHM309	GREEN CHEMISTRY	2	SPR	HORIKOSHI, Satoshi	1~4	
	SML6660E	PHY301	RADIATION PHYSICS AND CHEMISTRY	2	SPR	ODAGIRI, Takeshi	1~4	
	SML6550E	CHM322	CATALYSIS CHEMISTRY	2	AUT	SUZUKI, Noriyuki	1~4	
	SML6560E	CHM319	CERAMICS & GLASS MATERIALS	2	AUT	ITATANI, Kiyoshi	1~4	
	SML6570E	PHY302	THEORY-AIDED MOLECULAR DESIGN	2	not offered	NANBU, Shinkoh	1~4	
	SML6580E	PHY305	QUANTUM REACTION DYNAMICS	2	AUT	HOSHINO, Masamitsu	1~4	
	SML6600E	BIO399	TOPICS OF GREEN SCIENCE 1	2	SPR	ARAKI, Tsuyoshi	1~4	
	SML6610E	CHM323	TOPICS OF GREEN SCIENCE 2	2	AUT	BRENNER, Tom	1~4	
	SML6620E	BIO398	TOPICS OF GREEN SCIENCE 3	2	AUT	ARAKI / SAITO	1~4	
	SML6590E	BIO323	TOPICS OF PLANT SCIENCE	2	SPR	SUZUKI / FUJIWARA	1~4	
	SML6630E	CHM301	STRUCTURAL CHEMISTRY	2	AUT	KUZE, Nobuhiko	1~4	☆
	SML6640E	CHM304	ION EXCHANGE IN ENVIRONMENTAL CHEMISTRY	2	not offered	HAYASHITA, Takashi	1~4	☆
	SML6671E	CHM399	GENERAL ORGANIC CHEMISTRY 2	2	SPR	SHING, Tony	1~4	★
	099712	GCL205	ENVIRONMENTAL SCIENCE	2	SPR / AUT	SUGIURA, Mikiko	1~4	
099716	GCE210	SUSTAINABLE DEVELOPMENT	2	SPR / AUT	SUGIURA, Mikiko	1~4		

☆ = Every Other Year

★ = Course taught by invited visiting professor

Course List

Department of Engineering and Applied Sciences (Green Engineering)

	Course No.	Numbering	Course title	Cr.	Semester offered	Instructor	Student Year	Remarks	
Department Core Courses	SEA2040E	MEC181	ENGINEERING AND APPLIED SCIENCES 1	2	AUT	SUEMASU, Hiroshi	2		
	SEA2050E	PHY102	ENGINEERING AND APPLIED SCIENCES 2	2	AUT	WANAJO, Shinya	2		
	SEA2060E	EEE202	ENGINEERING AND APPLIED SCIENCES 3	2	AUT	KATAYAMA, Kozo	2		
	SEA2070E	EAS191	ENGINEERING AND APPLIED SCIENCES LAB. 1	1	AUT	SUZUKI / TAKAYANAGI / SUEMASU / TSUKIJI / HISAMORI / KISHINO / KIKUCHI / NAKAMURA / DZIEMINSKA	2		
	SEA2080E	EAS291	ENGINEERING AND APPLIED SCIENCES LAB. 2	1	SPR	KIKUCHI / TAKEHARA / MUTO / TAKAI / TANAKA/GOTO/KUWAHARA/EMA /WATANABE/KISHINO / SHIMOMURA / NAKAMURA / DZIEMINSKA / KATAYAMA	2		
	SEA5140E	PHY395	GREEN ENGINEERING LAB. 1	1	AUT	WANAJO, Shinya	3		
	SEA5150E	MEC391	GREEN ENGINEERING LAB. 2	1	SPR	ICHIYANAGI / SAKAMOTO / NAGASHIMA / SHEN / TAKEHARA / SUZUKI	3		
	SEA5160E	EEE395	GREEN ENGINEERING LAB. 3	1	AUT	MIYATAKE / TAKAO / NOMURA / SAKAMOTO / KATAYAMA	4		
	SEA5170E	EAS301	TOPICS OF GREEN ENGINEERING 1	2	AUT	DZIEMINSKA, Edyta	3		
	SEA5180E	EAS302	TOPICS OF GREEN ENGINEERING 2	2	AUT	McCALLUM, Stuart*	3		
	SEA4030E	EAS401	GRADUATION RESEARCH 1	1	AUT	Supervisor	4		
	SEA4040E	EAS402	GRADUATION RESEARCH 2	1	SPR	Supervisor	4		
	Department Specialized Courses	SEA6520E	MEC331	THERMAL ENERGY CONVERSION	2	AUT	SUZUKI, Takashi	1~ 4	
		SEA6530E	MEC321	FLUID ENERGY CONVERSION	2	SPR	WATANABE, Mariko	1~ 4	
SEA6540E		MEC352	ENERGY & MATERIALS	2	AUT	TAKAI, Kenichi	1~ 4		
SEA6550E		EEE327	NUCLEAR ENERGY ENGINEERING	2	AUT	LIEM PENG HONG*/ SHINOHARA* / TORATA* / IKUTA* / MIYATAKE / YAGAI / SAKAMOTO / McCALLUM*	1~ 4	Every Other Week	
SEA6670E		PHY308	COSMIC PERSPECTIVE	2	SPR	WANAJO, Shinya	1~ 4		
SEA6640E		EEE323	ELECTRICAL DRIVES AND CONTROLS	2	SPR	MIYATAKE, Masafumi	1~ 4	☆	
SEA6590E		EEE328	CLEAN ENERGY	2	SPR	YAGAI, Tsuyoshi	1~ 4		
SEA6600E		EAS321	SIMULATION ENGINEERING	2	AUT	GONSALVES, Tad	1~ 4		
SEA6610E		INF337	COMMUNICATION AND NETWORK ENGINEERING	2	SPR	BANDAI / OGAWA / HAYASHI / TAKAHASHI	1~ 4		
SEA6620E		EAS411	TOPICS OF GREEN ENGINEERING 3	2	SPR	KATAYAMA, Kozo	1~ 4		
SEA6650E		EAS412	AIRCRAFT DESIGN WITH MECHANIC OF FLIGHT	2	SPR	DZIEMINSKA, Edyta	1~ 4		
SEA6660E		EEE329	PHYSICS AND ENGINEERING OF ELECTRONIC DEVICES	2	AUT	KATAYAMA, Kozo	1~ 4		
SEA6585E		EEE325	POWER ELECTRONICS	2	not offered	MIYATAKE, Masafumi	1~ 4	☆	
SEA6580E		EEE326	ELECTRIC POWER SYSTEM ENGINEERING	2	SPR	MUSTI, Sastry	1~ 4	★[30]	
099712		GCL205	ENVIRONMENTAL SCIENCE	2	SPR / AUT	SUGIURA, Mikiko	1~ 4		
099716	GCE210	SUSTAINABLE DEVELOPMENT	2	SPR / AUT	SUGIURA, Mikiko	1~ 4			

[]=Lottery Courses. Number in brackets is the capacity.

Instructor's name with * = adjunct instructor

☆=Every Other Year

★ = Course taught by invited visiting professor

* Although the language of instruction for the following courses are different, courses listed are regarded as identical courses.

The students may only take one of the two courses.

English			Japanese	
Course No.	Course Title		Course No.	Course Title
SCT6740E	THERMODYNAMICS	⇔	SCT68300	熱力学
SCT6760E	INTRODUCTION TO QUANTUM DYNAMICS	⇔	SCT68900	量子力学入門
SCT6770E	ATOMIC & MOLECULAR SCIENCES	⇔	SCT64800	原子・分子科学
SCT6680E	LIFE CYCLE ASSESSMENT	⇔	SEA67050	ライフサイクルアセスメント
SCT6650E	MOLECULAR BIOLOGY	⇔	SCT66800	分子生物学
SCT6750E	CELL BIOLOGY	⇔	SCT62300	細胞生物学
SCT6800E	ORGANIC CHEMISTRY	⇔	SCT60600	有機化学 (有機分子)
SCT6865E	ELECTRIC CIRCUITS	⇔	SCT68600	電気回路II
SML6510E	ORGANIC AND NATURAL PRODUCT CHEMISTRY	⇔	SML61500	天然有機化学
SML6530E	GREEN CHEMISTRY	⇔	SML61700	グリーンケミストリー
SML6660E	RADIATION PHYSICS AND CHEMISTRY	⇔	SML62500	放射線科学
SML6550E	CATALYSIS CHEMISTRY	⇔	SML65300	触媒反応化学
SML6570E	THEORY-AIDED MOLECULAR DESIGN	⇔	SML64200	理論分子設計
SML6580E	QUANTUM REACTION DYNAMICS	⇔	SML65100	原子衝突物理学
SML6590E	TOPICS OF PLANT SCIENCE	⇔	SML65200	植物生理学
SML6630E	STRUCTURAL CHEMISTRY	⇔	SML60100	分子構造化学
SML6640E	ION EXCHANGE IN ENVIRONMENTAL CHEMISTRY	⇔	SML60400	分離分析化学
SEA2040E	ENGINEERING AND APPLIED SCIENCES 1	⇔	SEA10200	機能創造理工学 1
SEA2050E	ENGINEERING AND APPLIED SCIENCES 2	⇔	SEA10300	機能創造理工学 2
SEA2060E	ENGINEERING AND APPLIED SCIENCES 3	⇔	SEA20400	機能創造理工学 3
SEA6520E	THERMAL ENERGY CONVERSION	⇔	SEA60400	熱エネルギー変換
SEA6530E	FLUID ENERGY CONVERSION	⇔	SEA60500	流体エネルギー変換
SEA6540E	ENERGY & MATERIALS	⇔	SEA61800	エネルギーと材料
SEA6550E	NUCLEAR ENERGY ENGINEERING	⇔	SEA61200	原子力エネルギー
SEA6560E	INTRODUCTION TO MATERIAL SCIENCES	⇔	SEA66600	物質科学入門
SEA6640E	ELECTRICAL DRIVES AND CONTROLS	⇔	SEA65900	電気機器制御
SEA6580E	ELECTRIC POWER SYSTEM ENGINEERING	⇔	SEA65600	電力系統工学
SEA6610E	COMMUNICATION AND NETWORK ENGINEERING	⇔	SIC61700	通信ネットワークシステム
SEA6590E	CLEAN ENERGY	⇔	SEA65700	電気機器学
SEA6585E	POWER ELECTRONICS	⇔	SEA65800	パワーエレクトロニクス

General Information

Class Advisor

… P. 90

Faculty Offices and Office Hours

… P. 90

Campus Map

… P. 93

Class Advisor

Students may consult the following advisers about studies, plans for the future, and student life issues.

For students entered in

	2017	2016	2015	2014	2013 and before
Department of Materials and Life Science (Green Science)	KONDO, Jiro	KONDO, Jiro	SUZUKI, Yumiko	SUZUKI, Yumiko	SAITO, Tamao
Department of Engineering and Applied Science (Green Engineering)	TANAKA, Hidetake	TANAKA, Hidetake	ADACHI, Tadashi	ADACHI, Tadashi	YAGAI, Tsuyoshi

Faculty Offices and Office Hours

Faculty of Science and Technology

Dean's Office 4-590 (ex. 3300)

Department of Materials and Life Sciences

Chairperson's Office 9-556A (ex. 3360)

Name	Room	Office Hours	Remarks
Araki, Tsuyoshi	9-756B	Mon-Fri 10:00-17:00	by e-mail appointment (t.araki@sophia.ac.jp)
Azuma, Yoshiro	4-391B	Mon-Fri 17:00-18:00	Try anytime (y-azuma@sophia.ac.jp)
Brenner, Tom	9-756A	Mon-Fri 10:00-17:00	by e-mail appointment (brenner@sophia.ac.jp)
Chiba, Atsuhiko	8-403B	Mon-Fri 10:00-17:00	by appointment
Danielache, Sebastian Oscar	9-454	Mon-Fri 10:00-18:00	by e-mail appointment (sebastian.d@sophia.ac.jp)
Endo, Akira	9-652C	Mon-Fri 10:00-17:00	by e-mail appointment
Fujita, Masahiro	4-373A	Mon-Fri 10:00-17:00	by e-mail appointment (masahi-f@sophia.ac.jp)
Fujiwara, Makoto	4-286	Mon-Fri 10:00-17:00	or by appointment
Hashimoto, Takeshi	9-651A	Thu, Fri 14:30-18:00	or by e-mail appointment
Hayashi, Kensuke	8-404B	Mon 12:30-13:20	or by appointment
Hayashita, Takashi	9-652B	Mon-Fri 10:00-18:00	by e-mail appointment (ta-hayas@sophia.ac.jp)
Horikoshi, Satoshi	8-402A	Mon-Fri 12:30-13:30	by appointment
Hoshino, Masamitsu	4-385A	Wed 10:00-12:30, 13:30-15:00	or by e-mail appointment
Itatani, Kiyoshi	9-558A	Mon-Fri 10:00-17:00	by e-mail appointment
Kanzawa, Nobuyuki	9-458	Mon-Fri 10:00-17:00	except a lecture, meeting time
Kawaguchi, Mari	4-581	Mon-Fri 10:00-17:00	by e-mail appointment
Kikawada, Yoshikazu	4-482	Fri 12:30-13:30	or by e-mail appointment
Kobayashi, Kenichiro	4-593B	Mon 16:00-17:00	or by appointment
Kondo, Jiro	4-383B	Mon-Fri 10:00-17:00	or by appointment
Kuze, Nobuhiko	4-497	Mon, Wed-Fri 12:40-13:20	or by appointment
Masuyama, Yoshiro	9-656C	Mon 15:30-18:00	by e-mail appointment
Chairperson Nagao, Hirota	4-491B	Mon-Fri 10:00-17:00	by appointment
Nanbu, Shinkoh	8-401A	Fri 11:00-18:00	or by appointment
Odagiri, Takeshi	4-291A	Mon-Fri 10:00-17:00	by e-mail appointment (odagiri.t@sophia.ac.jp)
Oi, Takao	8-401B	Mon-Fri 9:30-17:00	by appointment
Okada, Kunihito	4-387B	Mon-Fri 12:40-13:20	by appointment
Rikukawa, Masahiro	4-481	Mon, Thu 12:30-13:30	or by e-mail appointment
Saito, Tamao	8-403A	Mon-Fri 10:00-17:00	by e-mail appointment (tasaito@sophia.ac.jp)
Suzuki, Nobuhiro	4-582	Tue 13:30-15:00 Wed-Thu 11:00-12:30	by e-mail appointment
Suzuki, Noriyuki	4-491A	Mon-Fri 10:00-17:00	by e-mail appointment
Suzuki, Yumiko	4-371	Mon-Fri 10:00-17:00	or by appointment
Takahashi, Kazuo	4-495B	Mon-Fri 10:00-17:00	by appointment
Takeoka, Yuko	4-485	Mon-Fri 10:00-17:00	by e-mail appointment (except a lecture)
Tanaka, Kunihito	4-493	Mon-Fri 10:00-17:00	or by appointment
Uchida, Hiroshi	9-595	Mon-Fri 10:00-17:00	by e-mail appointment
Usuki, Toyonobu	4-474A	Tue 13:30-15:00	by appointment
Yasumasu, Shigeki	9-755	Mon-Fri 10:00-17:00	by appointment

Department of Engineering and Applied Sciences
 Chairperson's Office 9-249B (ex. 3310)

Name	Room	Office Hours	Remarks
Adachi, Tadashi	4-291B	Thu 17:00-18:00	or by e-mail appointment
Dzieminska, Edyta	8-205B	Mon-Fri 9:30-17:00	by e-mail appointment
Ema, Kazuhiro	8-306B	Mon, Fri 11:00-12:30	by e-mail appointment
Goto, Takayuki	8-303B	Mon-Fri 16:00-18:00	except a lecture, meeting time
Hirano, Tetsufumi	4-385B	Mon 9:15-10:45	by e-mail appointment
Hisamori, Noriyuki	KH-426	Mon-Fri 11:00-17:00	
Ichiyanagi, Mitsuhisa	8-204B	Mon-Fri 11:00-17:00	by e-mail appointment
Katayama, Kozo	9-758B	Mon-Fri 11:00-17:00	by e-mail appointment
Kikuchi, Akihiko	4-292	Tue, Wed, Thu 12:30-13:30	by e-mail appointment
Kishino, Katsumi	8-301B	Tue, Fri 12:30-13:30, Tue 16:00-	by e-mail appointment
Kunugita, Hideyuki	8-305B	Wed 13:30-14:30	by e-mail appointment
Kuroe, Haruhiko	8-302B	Mon-Fri 11:00-12:30, 13:30-15:00	except a lecture, meeting time by e-mail appointment
Kuwahara, Hideki	4-381	Fri 17:00-18:00	or by e-mail appointment
Miyatake, Masafumi	9-357	Mon 12:15~13:45, Thu 12:15-13:15	or by appointment
Muto, Yasuhiko	8-202B	Mon-Fri 11:00-17:00	by appointment
Nagashima, Toshio	9-554A	Mon 12:30-13:30	or by e-mail appointment
Nakamura, Kazuya	4-296	Mon-Fri 11:00-17:00	by e-mail appointment
Nakaoka, Toshihiro	4-175D	Mon-Fri 10:00-17:00	by e-mail appointment
Nomura, Ichiro	4-182	Mon-Fri 10:00-12:30, 13:30-17:00	by e-mail appointment
Ohtsuki, Tomi	4-389A	Fri 11:00-13:30	by e-mail appointment
Sakama, Hiroshi	8-304B	Mon-Fri 12:30-13:30	by appointment
Sakamoto, Haruhisa	KH-327	Mon-Fri 13:30-19:00	by e-mail appointment (h-sakamo@sophia.ac.jp)
Sakamoto, Oriie	9-754A	Wed 11:00-12:30	or by appointment
Shen, Tielong	8-201B	Mon-Fri 11:00-17:00	
Shimomura, Kazuhiko	4-556B	Mon-Fri 10:00-17:00	
Suemasu, Hiroshi	9-554B	Tue-Fri 11:00-17:00	
Suzuki, Hiroshi	MH-115E	Mon-Fri 11:00-17:00	
Suzuki, Takashi	8-203B	Mon-Fri 9:00-18:00	by e-mail appointment
Chairperson Takai, Kenichi	KH-428	Mon-Fri 10:00-18:00	
Takao, Tomoaki	4-284C	Mon-Fri 12:30-13:30	by e-mail appointment
Takayanagi, Kazuo	4-383A	Mon-Fri 13:30-17:00	except a lecture, meeting time by appointment
Takehara, Shoichiro	KH-326	Mon, Tue, Wed 12:30-15:00	except a lecture, meeting time by appointment
Tanaka, Hidetake	KH-329	Mon-Fri 13:30-17:00	by appointment
Terumichi, Yoshiaki	4-185B	Tue 12:30-13:30	by e-mail appointment (y-terumi@sophia.ac.jp)
Tsukiji, Tetsuhiro	8-206B	Wed 12:30-13:30	by e-mail appointment
Wanajo, Shinya	9-758A	Mon-Fri 11:00-17:00	by e-mail appointment
Watanabe, Mariko	8-206A	Thu 16:00-17:00	by appointment
Yagai, Tsuyoshi	4-190	Mon-Fri 11:00-17:00	by e-mail appointment

KH = Krupp Hall

MH = Machine Hall

Department of Information and Communication Sciences
 Chairperson's Office I-107A (ex. 3320)

Name	Room	Office Hours	Remarks
Arai, Takayuki	4-290	(SPR) Mon 10:00-11:00 (AUT) Mon 11:00-12:00	by e-mail appointment
Bandai, Masaki	I-301B	Fri 12:30-13:30	or by e-mail appointment
Fujii, Mamiko	I-120A	Mon 12:00-13:00	or by e-mail appointment
Gomi, Yasushi	I-407	(SPR) Fri 12:30-13:30 (AUT) Mon 12:30-13:30	by appointment
Gonsalves, Tad	I-209B	Mon-Fri 13:00-13:30	by appointment
Goto, Satoshi	I-401B	Tue 9:15-10:45	by e-mail appointment
Hayashi, Hitoshi	I-118B	Fri 12:40-13:10	by appointment
Hirata, Hitoshi	I-403	Fri 13:30-15:00	or by e-mail appointment
Irohara, Takashi	KH-528	Tue 12:30-13:30	by e-mail appointment
Kato, Takeshi	I-412	Thu 17:00-18:30	by appointment
Kawabata, Ryo	I-208B	(SPR) Mon 13:30-14:30 (AUT) Mon 15:45-16:30	or by e-mail appointment
Kawanaka, Akira	I-310	Mon, Wed-Fri 12:30-13:30	by e-mail appointment
Miyamoto, Yuichiro	I-308B	Fri 12:30-13:30	by e-mail appointment
Nakashima, Toshiki	I-410	Tue 12:30-13:30	by appointment
Nakasuji, Maki	I-414	Fri 10:00-11:00	or by e-mail appointment
Niikura, Takako	8-405B	Fri 12:30-13:30	or by e-mail appointment
Ogawa, Masakatsu	I-307B	Fri 12:30-13:30	by e-mail appointment
Ooshiro, Kanako	I-416	Mon 9:15-12:30	or by e-mail appointment
Chairperson Sasakawa, Nobuyuki	8-405A	Fri 12:30-13:30	or by e-mail appointment
Shibuya, Tomoharu	I-405	Mon 12:00-13:00	or by e-mail appointment
Sumi, Chikayoshi	I-017C	Mon-Fri 13:00-13:30	by e-mail appointment
Takahashi, Hiroshi	I-110	Mon, Tue, Wed 8:00-14:00	or by e-mail appointment
Takaoka, Eiko	IR-303	Wed 17:00-18:00	by appointment
Tamura, Yasuhisa	I-309B	Thu, Fri 12:30-13:30	by e-mail appointment
Tanaka, Shoji	I-302	Mon-Fri 12:30-13:30	by e-mail appointment
Trihan, Fabien	I-418	Fri 12:30-13:30	by e-mail appointment
Tsuji, Hajime	I-409	Tue 12:30-13:30	by appointment
Tsunogai, Hiroshi	I-406	(SPR) Fri 12:30-13:30 (AUT) Thu 12:30-13:30	by e-mail appointment
Tsuzuki, Masao	I-411	Fri 12:30-13:30	by appointment
Waho, Takao	4-284A	Fri 15:15-16:45	by appointment
Yairi, Ikuko	I-401C	Mon 13:30-16:45	by appointment
Yamanaka, Takao	I-202	Mon-Fri 12:30-13:30	by e-mail appointment
Yamashita, Haruka	I-207B	Mon-Fri 12:30-13:30	by e-mail appointment

"I" = Ichigaya Campus Main Building

"IR" = Ichigaya Campus Research Building

"KH" = Krupp Hall

"MH" = Machine Hall



Yotsuya Campus
四谷キャンパス

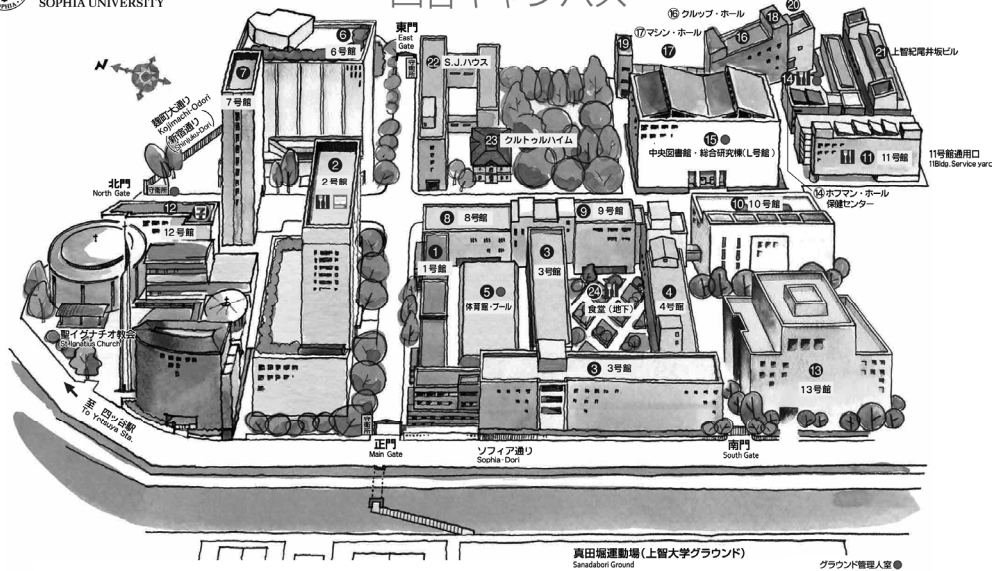

- | | | | | |
|---------------------|--------------------|--------------------------------------|----------------------------------|---|
| ● 1号館 Bldg. No.1 | ● 6号館 Bldg. No.6 | ● 12号館 Bldg. No.12 | ● クループ・ホール Krupp Hall | ● S.J.ハウス S.J. House |
| ● 2号館 Bldg. No.2 | ● 7号館 Bldg. No.7 | ● 13号館 Bldg. No.13 | ● マンシオン・ホール Machine Hall | ● クルトゥルハイム Kulturheim |
| ● 3号館 Bldg. No.3 | ● 8号館 Bldg. No.8 | ● ホフマン・ホール Hofmann Hall | ● パワーステーションⅠ Power Station I | ● 購買 紀伊國屋書店 上智大学店 地下 (basement) |
| ● 4号館 Bldg. No.4 | ● 9号館 Bldg. No.9 | ● ヘALTH センター Health Center | ● パワーステーションⅡ Power Station II | ● 食堂 Restaurant 5階 (5F) 地下 (basement) |
| ● 5号館 Bldg. No.5 | ● 10号館 Bldg. No.10 | ● 中央図書館 Central Library | ● パワーステーションⅢ Power Station III | ● AEI (自動体外起震器施設) 学務科 自動体外起震器施設 地下 (basement) |
| ● 体育館 Gymnasium | ● 11号館 Bldg. No.11 | ● 総合研究棟(L号館) and Research Institutes | ● 上野紀尾井坂ビル Jochi Kiokizaka Bldg. | ● コンビニエンスストア Convenience Store 地下 (basement) |
| ● プール Swimming Pool | | | | |

● 市谷キャンパスアクセスガイド
Ichigaya Campus Access Guide



Yotsuya Campus

Bulletin Boards in Building No.2 1F

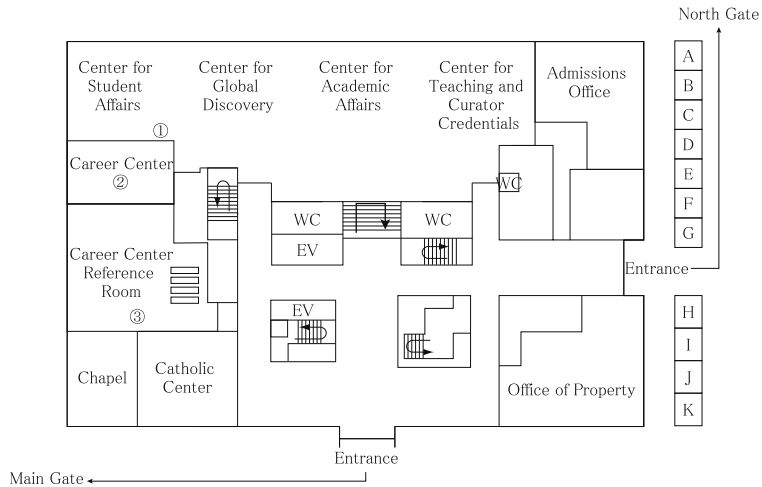

- | | | | |
|---|----------------------------|---|-----------------------------|
| ① | Center for Student Affairs | A | Admissions Office |
| ② | Career Center | B | Campus Membership |
| ③ | | C | |
| | | D | Center for Academic Affairs |
| | | E | |
| | | F | |
| | | G | |
| | | H | Center for Student Affairs |
| | | I | |
| | | J | Career Center |
| | | K | Center for Global Discovery |

Building No.1,3,4,8,9

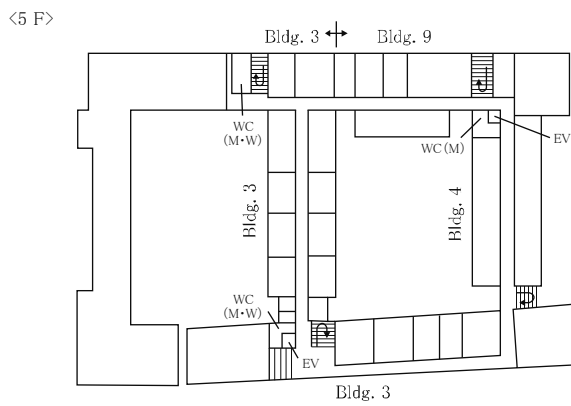
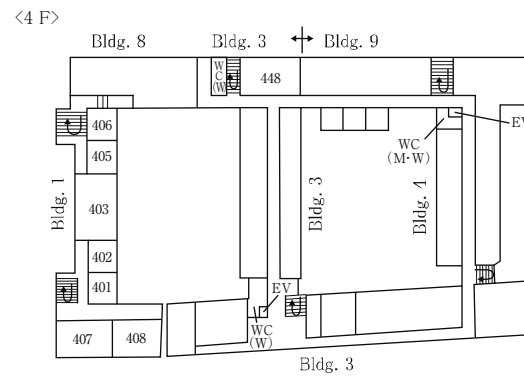
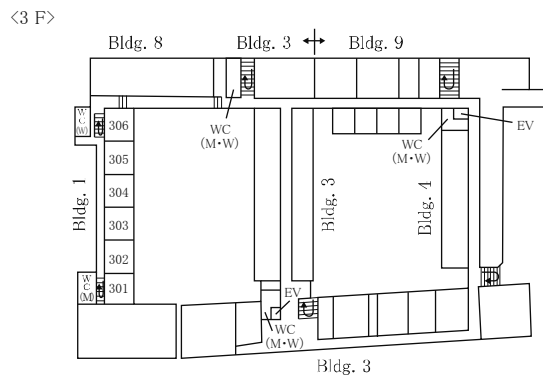
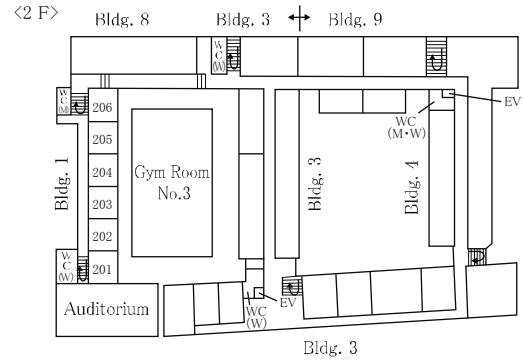
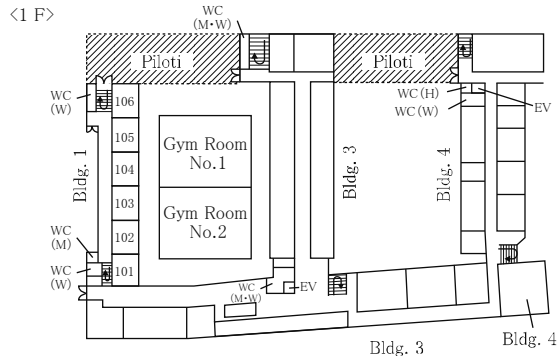

Building No.2

<B2 F>

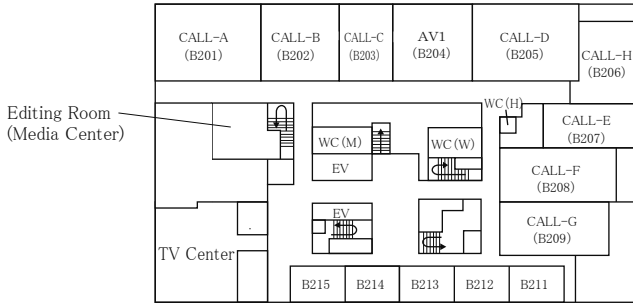

<B1 F>

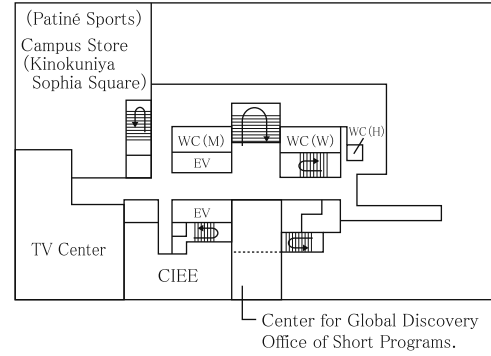

<1 F>

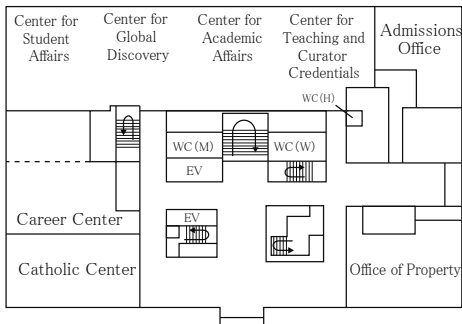

<2 F>

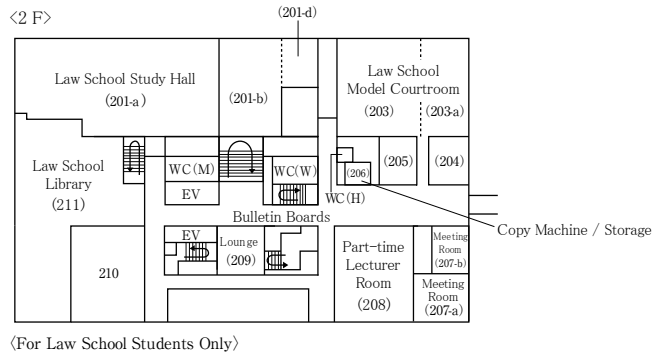

(For Law School Students Only)

<3 F>

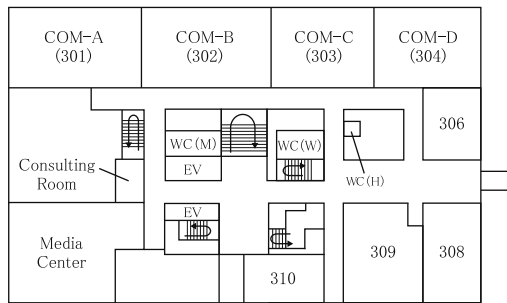

<4 F>

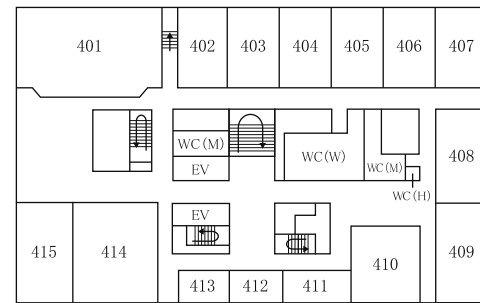

<5 F>

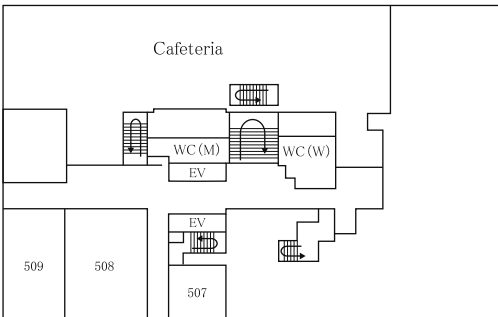

Building No.6

(1F)

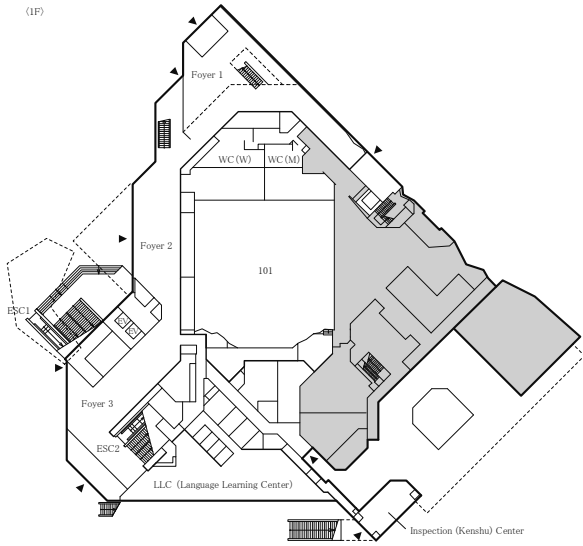

(2F)

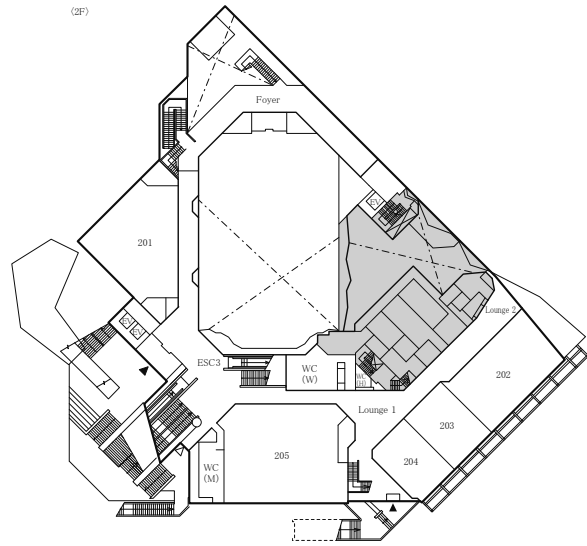

(3F)

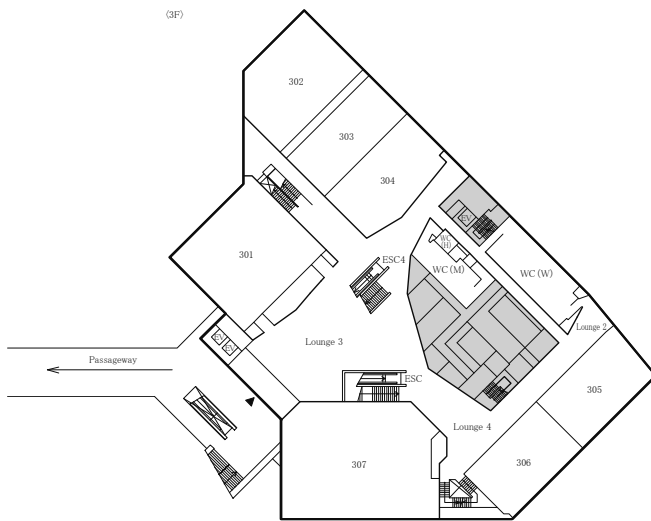

(4F)

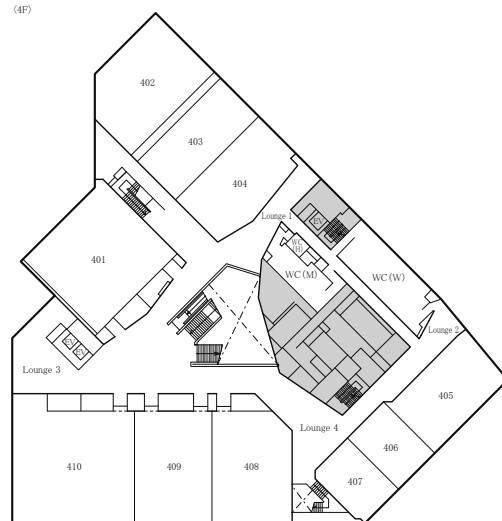

(5F)

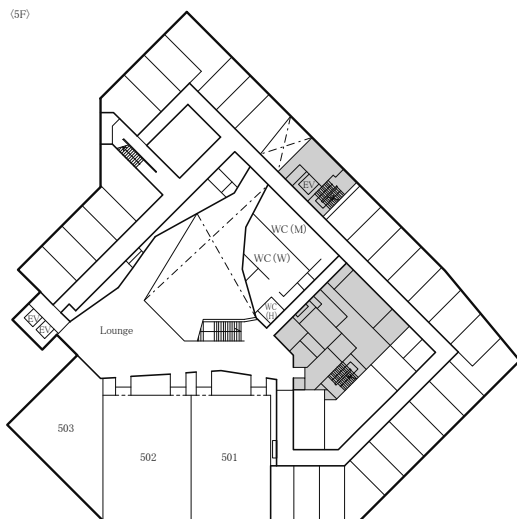

Central Library (Building L)

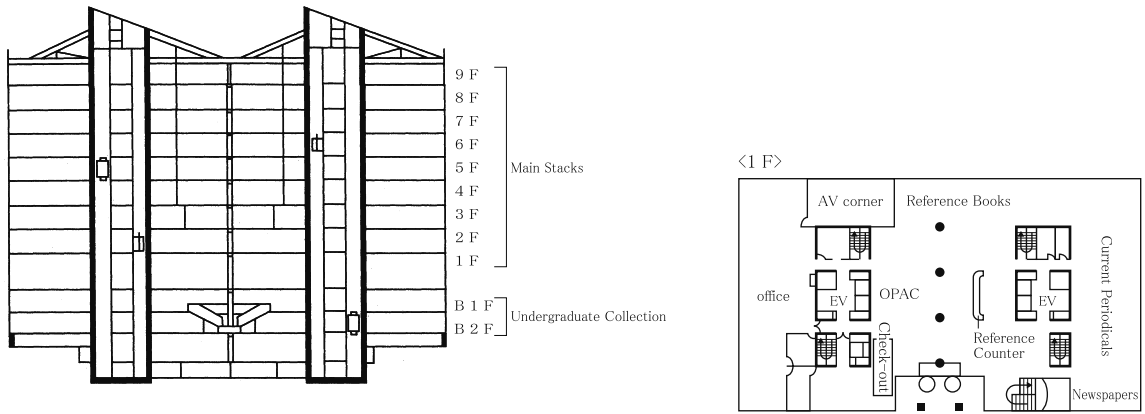

Building No.10

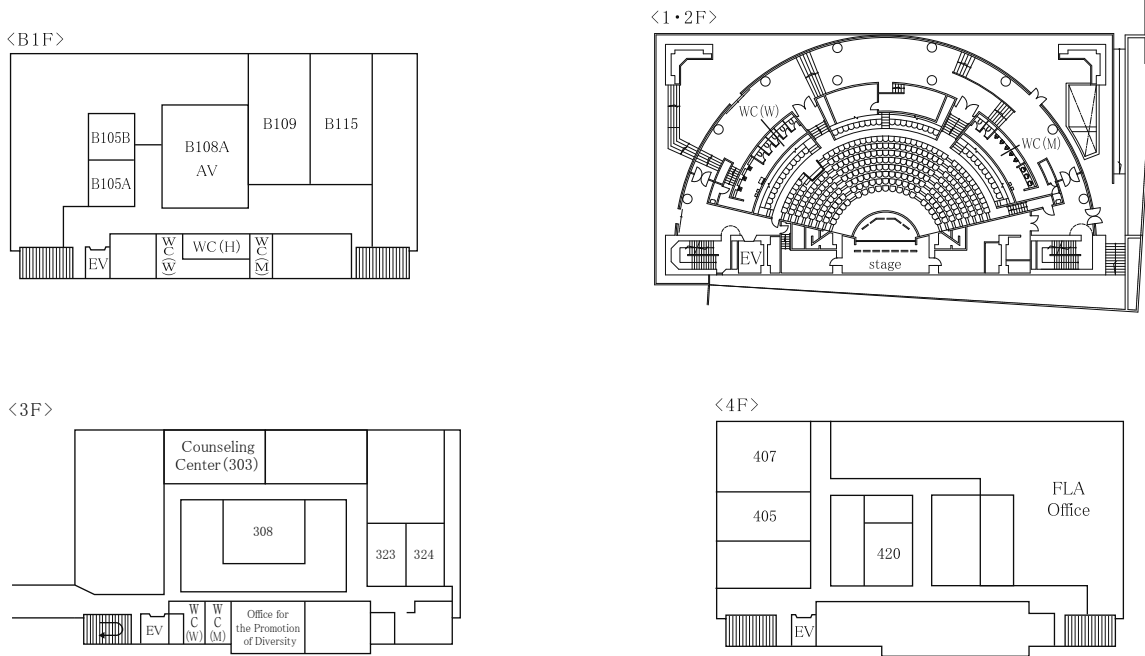

Building No.11 & Jochi Kioizaka Building

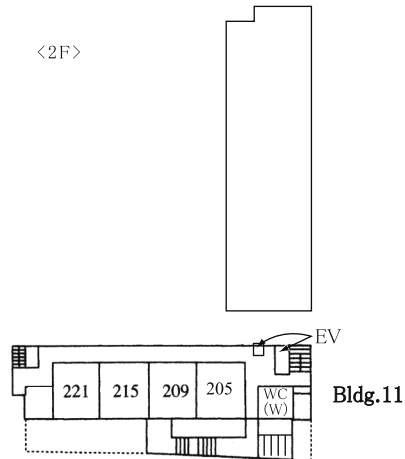
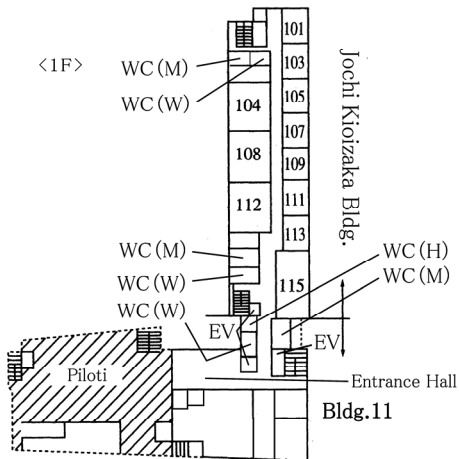
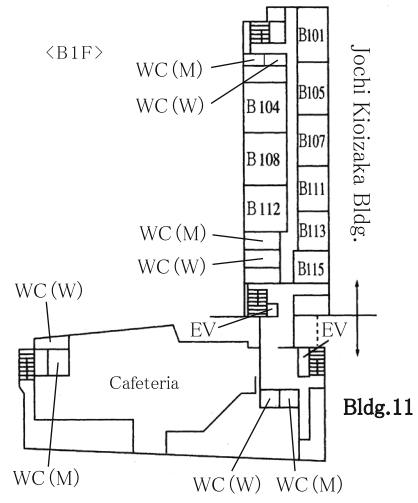
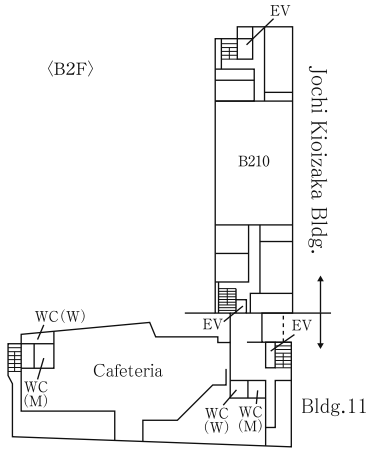

Building No.11

< 3 F >

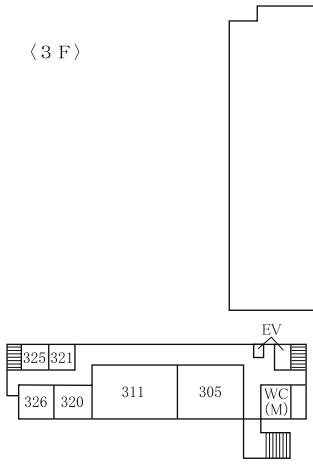

< 4 F >

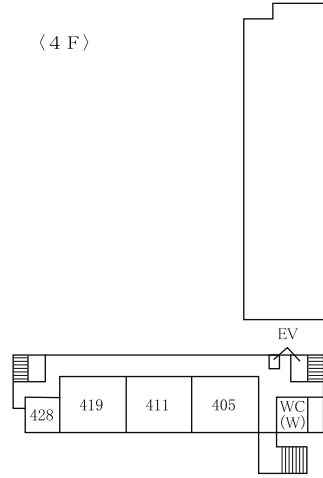

< 5 F >

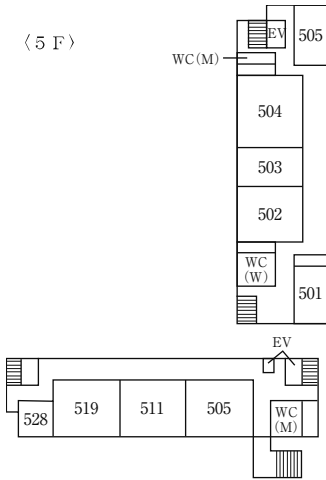

< 6 F >

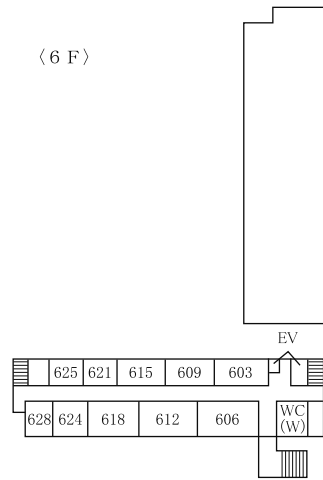

< 7 F >

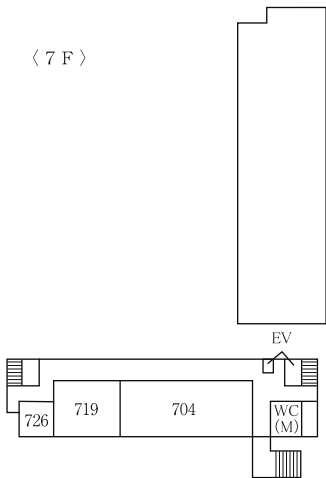

Building No.12

(B1F)

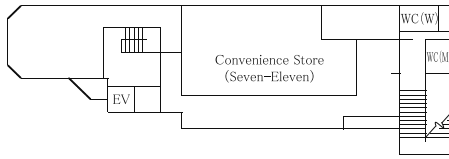

(1F)

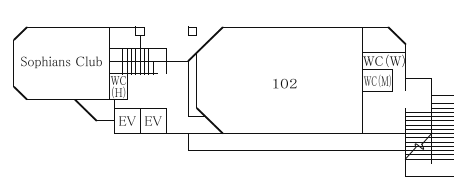

(2F)

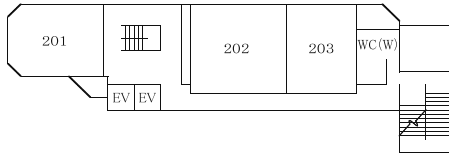

(3F)

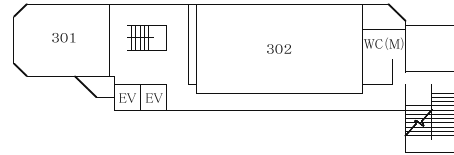

(4F)

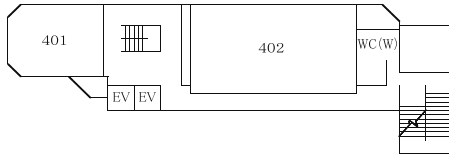

(5F)

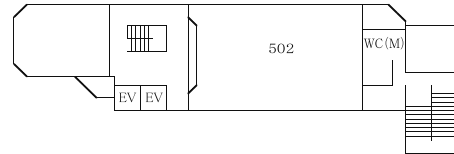

Krupp Hall / Machine Hall

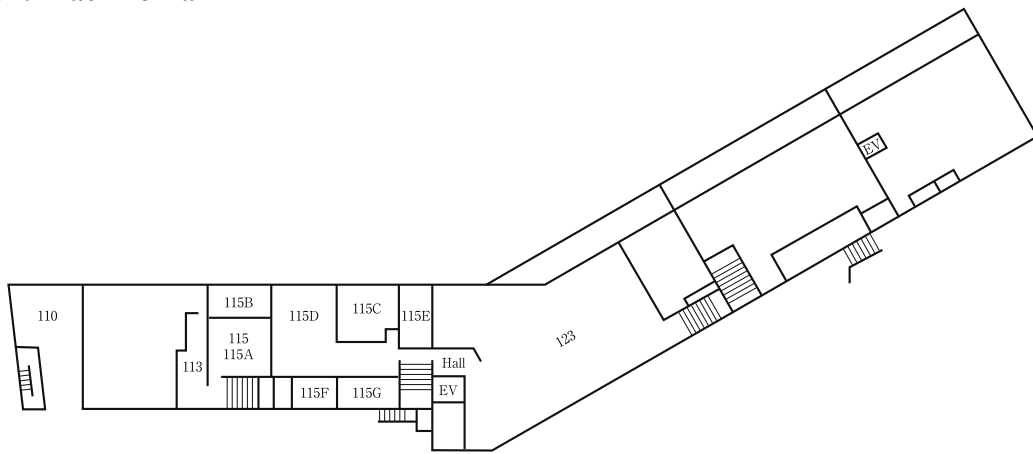

1F

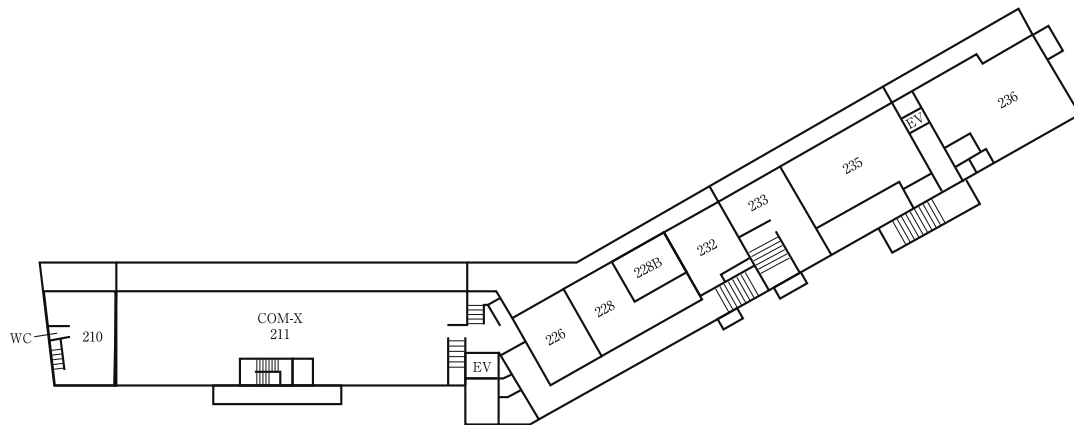

2F

Ichigaya Campus

Main Building

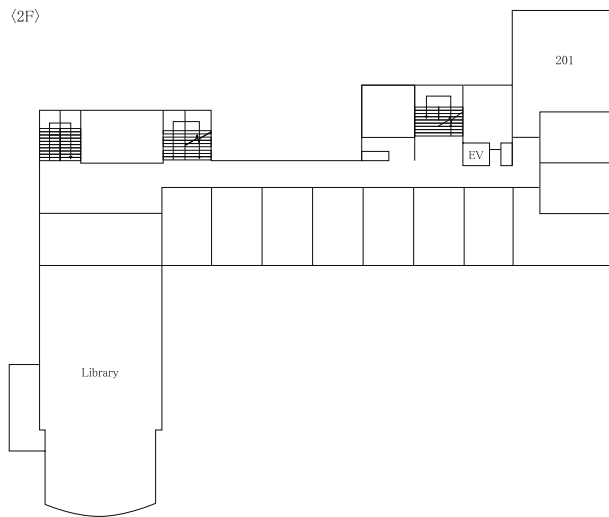
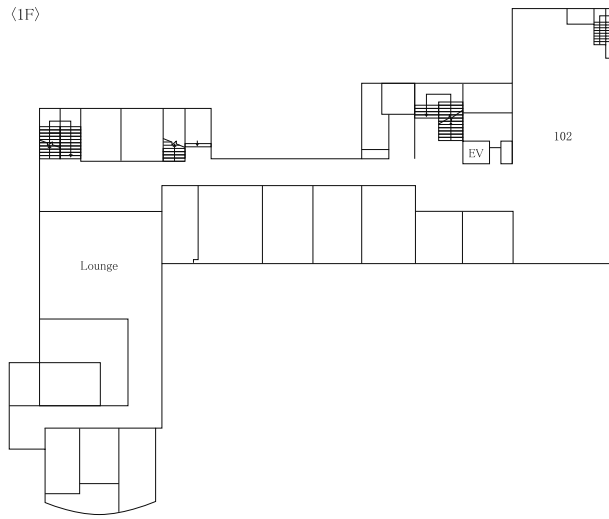

Research Building

